

Single-phase full-wave motor driver

BA6427F

The BA6427F is a single-phase full-wave motor driver for fan motors. By using this driver, a single-phase, full-wave motor driver circuit can be built with fewer components than a circuit using operational amplifiers. Lock detection and automatic restart mechanisms, which are required for fan motors, are also built in. A rotational-speed sensing output pin is provided for Ho output.

●Applications

Single-phase, full-wave fan motors

●Features

- 1) Equipped with lock detection and rotational-speed sensing functions.
- 2) Compact SOP-8 package reduces the number of external components for a reduced mounting area.
- 3) Automatic restart when the motor lock is undone.

●Absolute maximum ratings (Ta = 25°C)

| Parameter | Symbol | Limits | Unit |
|---|--------------------|----------|------|
| Applied voltage | V _{CC} | 15 | V |
| Power dissipation | P _d | 550*1 | mW |
| Operating temperature | T _{opr} | -35~+85 | °C |
| Storage temperature | T _{stg} | -55~+150 | °C |
| Output current | I _{oMax.} | 700*2 | mA |
| Output withstanding voltage | V _{OUT} | 15 | V |
| Hall signal output pin withstanding voltage | V _{HO} | 15 | V |

*1 Reduced by 4.4mW for each increase in Ta of 1°C over 25°C.
When mounted on a 50mm × 50mm × 1.6mm glass epoxy board.

*2 Should not exceed Pd or ASO values.

●Recommended operating conditions

| Parameter | Symbol | Limits | Unit |
|--------------------------------|-----------------|----------|------|
| Operating power supply voltage | V _{CC} | 3.0~14.0 | V |

●Block diagram

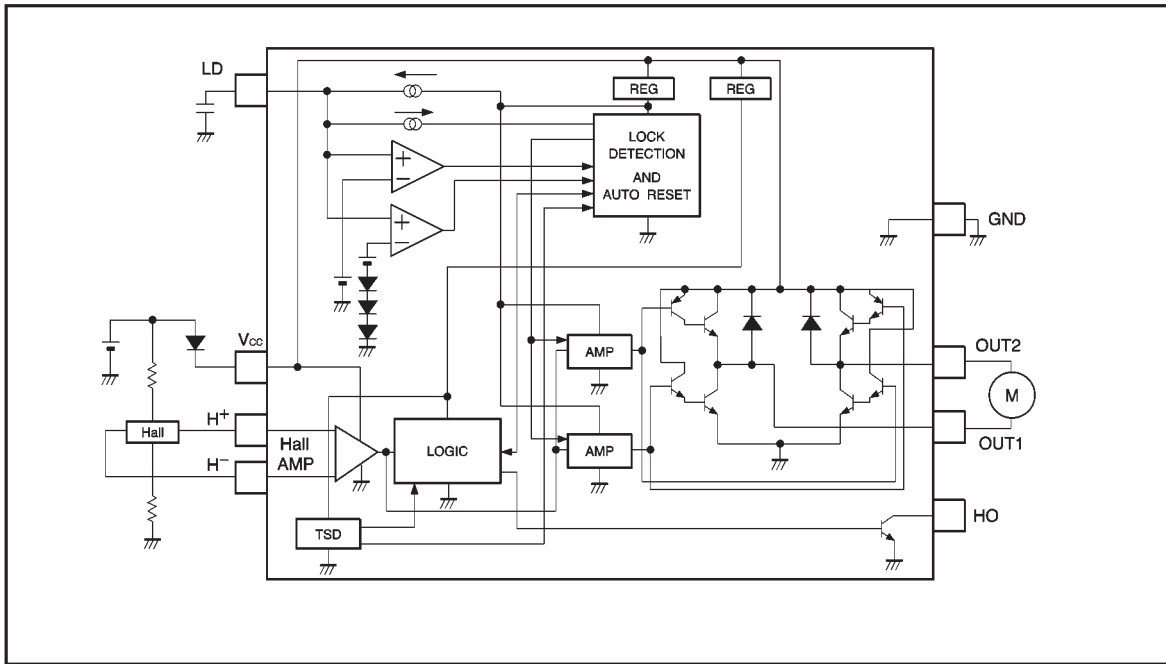

●Pin descriptions

| Pin No. | Pin name | Function |
|---------|----------------|---|
| 1 | OUT2 | Output 2 |
| 2 | HO | Hall signal output |
| 3 | LD | Capacitor connection pin for lock detection and automatic restart |
| 4 | Vcc | Power supply |
| 5 | H ⁺ | Hall input (+) |
| 6 | H ⁻ | Hall input (-) |
| 7 | OUT1 | Output 1 |
| 8 | GND | GND |

●Truth table

| H ⁺ | H ⁻ | OUT1 | OUT2 | HO |
|----------------|----------------|------|------|----|
| H | L | H | L | H |
| L | H | L | H | L |

●Electrical characteristics (unless otherwise noted, Ta = 25°C, V_{CC} = 5V)

| Parameter | Symbol | Min. | Typ. | Max. | Unit | Coniditions |
|---|-------------------|------|------|------|------|--|
| Circuit current | I _{CC} | 2.2 | 4.5 | 9.0 | mA | During output OFF |
| Lock detection capacitor charge current | I _{LDC} | 1.60 | 2.9 | 4.64 | μA | V _{LD} =1.1V |
| Lock detection capacitor discharge current | I _{LDD} | 0.24 | 0.48 | 0.80 | μA | V _{LD} =1.1V |
| Lock detection capacitor charge / discharge ratio | r _{CD} | 4.5 | 6.0 | 10.0 | — | r _{CD} =I _{LDC} / I _{LDD} |
| Lock detection capacitor clamp voltage | V _{LDCL} | 1.27 | 1.93 | 2.60 | V | — |
| Lock detection capacitor comparator voltage | V _{LDCP} | 0.47 | 0.76 | 1.06 | V | — |
| Output low level voltage | V _{OL} | — | 0.2 | 0.3 | V | I _o =200mA |
| Output high level voltage | V _{OH} | 3.4 | 4.1 | — | V | I _o =200mA |
| Hall signal output pin low level voltage | V _{HOL} | — | 0.3 | 0.5 | V | I _{HO} =5mA |
| Hall signal output pin leak current | I _{HOL} | — | 0 | 50 | μA | V _{HO} =15V |

● Lock detection

The automatic restart circuit detects a motor lock condition and automatically turns off the output power. When the lock condition is cleared, the IC automatically restarts and allow the motor to run.

In the BA6427F, automatic restart is performed as follows.

A motor lock condition is detected when the Hall signal stops switching. The output is OFF when the LD pin is being charged.

(1) The HO pin outputs a signal synchronized with the Hall signal.

(2) The HO pin is an open collector output.

The time required for the external capacitor at the LD pin to charge or discharge when the motor is locked varies with the capacitor size. The charge and discharge times are obtained by:

$$T_{ON} \text{ (charge time)} = \frac{C (V_{LDCL} - V_{LDPC})}{I_{LDC}}$$

$$T_{OFF} \text{ (discharge time)} = \frac{C (V_{LDCL} - V_{LDPC})}{I_{LDD}}$$

C is the capacitance of the external capacitor connected to the LD pin,

V_{LDCL} is the LD pin clamp voltage (1.93V Typ.),

V_{LDPC} is the LD pin comparator voltage (0.76V Typ.),

I_{LDC} is the LD pin charge current (2.9μA Typ.),

I_{LDD} is the LD pin discharge current (0.48μA Typ.).

For $C = 0.47\mu\text{F}$, for example, the charge and discharge times are 0.19 s (output ON) and 1.15 s (output OFF), respectively.

The timing of the LD pin is shown in Fig.1.

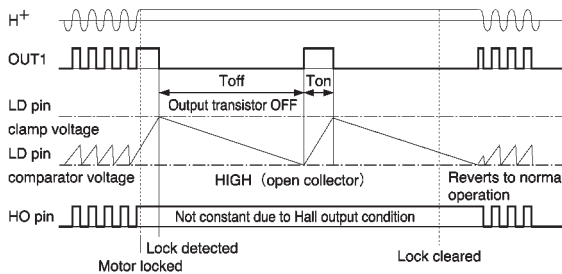

Fig.1 Timing chart of the LD and HO pins

● Operation notes

(1) Thermal shutdown circuit

The IC has a built-in thermal shutdown circuit. There is a degree of hysteresis in the TSD circuit.

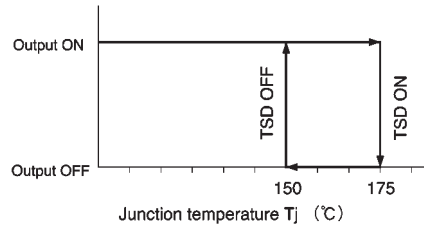

Fig.2 TSD

The circuit is activated at the temperature of about 175°C (typical), so that all outputs are turned OFF. The circuit is deactivated when the temperature drops to about 150°C, and normal operation resumes. (With the typical values, there is a hysteresis of 25°C.)

(2) Current consumption

The power dissipated by the IC varies widely with the supply voltage and the output current. Make sure that your application does not exceed the allowable power dissipation of the IC package.

(3) Hall input pins (H^+ , H^-)

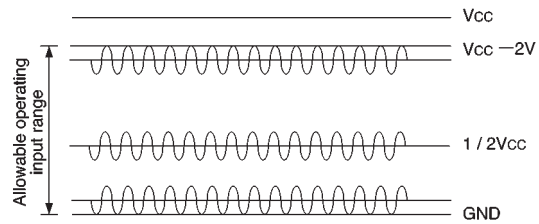

Fig.3 Allowable range of the Hall amplifier input voltage

1) The values of the Hall device bias resistors (see the block diagram) must be set so as to maintain the Hall amplifier input bias voltage within the range of 0V to $V_{CC}-2V$, including the signal amplitude. It is recommended that the same value be used for both resistors so that the Hall device output signal centered around $V_{CC} / 2$ is input to the IC.

2) Be careful of the input signal for the Hall inputs of this IC have no hysteresis.

(4) ASO

Make sure that the output current will not exceed the absolute maximum rating or the ASO value.

(5) Ground pin potential

Be sure to keep the GND potential lower than the potentials of the other pins.

●Electrical characteristic curves

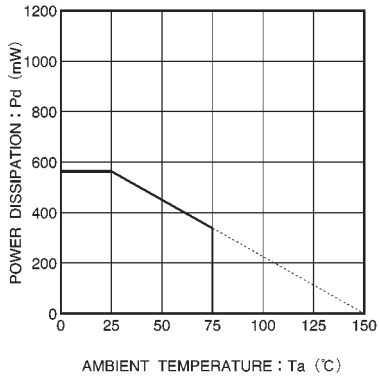

Fig.4 Power dissipation

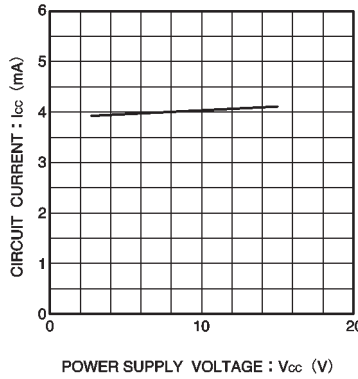

Fig.5 Circuit current vs. power supply voltage

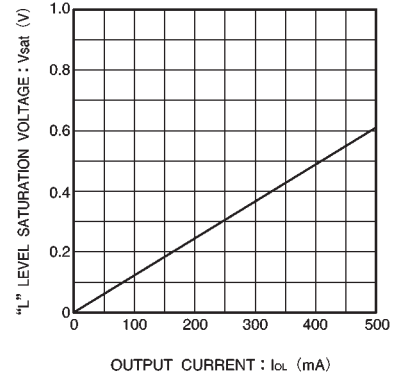

Fig.6 Low level saturation voltage vs. output current

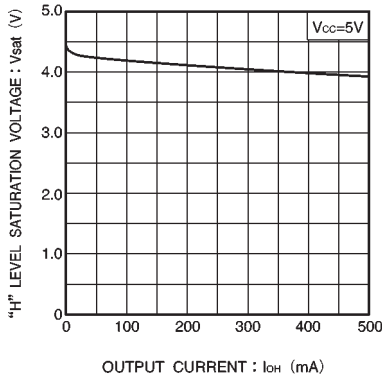

Fig.7 High level saturation voltage vs. output current

●External dimensions (Units: mm)

