

1.2A 1.6MHz Low Quiescent Current High Efficiency Synchronous Buck Regulator

ISL9106 is a 1.2A, 1.6MHz step-down regulator, which is ideal for powering low-voltage microprocessors in compact devices such as PDAs and cellular phones. It is optimized for generating low output voltages down to 0.8V. The supply voltage range is from 2.7V to 5.5V allowing the use of a single Li+ cell, three NiMH cells or a regulated 5V input. 1.6MHz pulse-width modulation (PWM) switching frequency allows using small external components. It has flexible operation mode selection of forced PWM mode and Skip (Low I_Q) mode with typical 17μA quiescent current for highest light load efficiency to maximize battery life.

The ISL9106 integrates a pair of low ON-resistance P-Channel and N-Channel MOSFETs to maximize efficiency and minimize external component count.

The ISL9106 offers a typical 215ms Power-Good (PG) timer when powered up. The timer output can be reset by RSI. When shutdown, ISL9106 discharges the output capacitor. Other features include internal digital soft-start, enable for power sequence, overcurrent protection, and thermal shutdown.

The ISL9106 is offered in 10 Ld 3mmx3mm DFN package with 0.9mm typical height. The complete converter can occupy less than 1cm² area.

Ordering Information

PART NUMBER (Note)	PART MARKING	TEMP. RANGE (°C)	PACKAGE (Pb-free)	PKG. DWG. #
ISL9106IRZ	106Z	-40 to +85	10 Ld 3x3 DFN	L10.3x3C
ISL9106IRZ-T	106Z	-40 to +85	10 Ld 3x3 DFN	L10.3x3C

NOTE: Intersil Pb-free plus anneal products employ special Pb-free material sets; molding compounds/die attach materials and 100% matte tin plate termination finish, which are RoHS compliant and compatible with both SnPb and Pb-free soldering operations. Intersil Pb-free products are MSL classified at Pb-free peak reflow temperatures that meet or exceed the Pb-free requirements of IPC/JEDEC J STD-020.

Features

- High Efficiency Integrated Synchronous Buck Regulator with up to 95% Efficiency
- 2.7V to 5.5V Supply Voltage
- 17μA Quiescent Supply Current in Skip (Low I_Q) Mode
- 1.2A Guaranteed Output Current
- 3% Output Accuracy Over Temperature/Load/Line
- Selectable Forced PWM Mode and Skip Mode
- Less than 1μA Logic Controlled Shutdown Current
- 100% Maximum Duty Cycle for Lowest Dropout
- Discharge Output Cap when Shutdown
- Internal Digital Soft-Start
- Peak Current Limiting, Short Circuit Protection
- Over-Temperature Protection
- Enable, Power Good Function
- 10 Ld 3mmx3mm DFN
- Pb-Free Plus Anneal Available (RoHS Compliant)

Applications

- Single Li-Ion Battery-Powered Equipment
- DSP Core Power
- PDAs and Palmtops

Pinout

ISL9106
(10 LD 3X3 DFN)
TOP VIEW

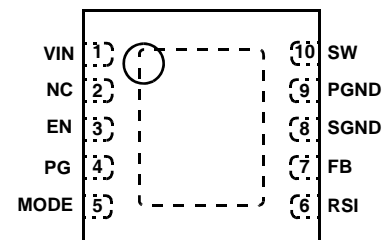

Absolute Maximum Ratings (Reference to SGND)

VIN	-0.3V to 6.5V
EN, RSI, MODE, PG	-0.3V to VIN + 0.3V
SW	-1.5V to 6.5V
FB	-0.3V to 2.7V
PGND	-0.3V to 0.3V

Recommended Operating Conditions

VIN Supply Voltage Range	2.7V to 5.5V
Load Current	0A to 1.2A
Ambient Temperature Range	-40°C to +85°C

Thermal Information

Thermal Resistance (Notes 1, 2)	θ_{JA} (°C/W)	θ_{JC} (°C/W)
3x3 DFN Package	44	5.5
Junction Temperature Range	-40°C to +125°C	
Storage Temperature Range	-65°C to +150°C	
Pb-free reflow profile	see link below	
http://www.intersil.com/pbfree/Pb-FreeReflow.asp		

CAUTION: Do not operate at or near the maximum ratings listed for extended periods of time. Exposure to such conditions may adversely impact product reliability and result in failures not covered by warranty.

NOTES:

- θ_{JA} is measured in free air with the component mounted on a high effective thermal conductivity test board with "direct attach" features. See Tech Brief TB379.
- θ_{JC} , "case temperature" location is at the center of the exposed metal pad on the package underside. See Tech Brief TB379.

Electrical Specifications Unless otherwise noted, all parameter limits are guaranteed over the recommended operating conditions and the typical specifications are measured at the following conditions: $T_A = +25^\circ\text{C}$, $V_{IN} = V_{EN} = V_{MODE} = 3.6\text{V}$, $V_{RSI} = 0\text{V}$, $L = 2.2\mu\text{H}$, $C_1 = 10\mu\text{F}$, $C_2 = 10\mu\text{F}$, $I_{OUT} = 0\text{A}$ (see the Typical Application Circuit).

PARAMETER	SYMBOL	TEST CONDITIONS	MIN	TYP	MAX	UNITS
SUPPLY						
Undervoltage Lockout Threshold	V_{UVLO}	Rising	-	2.5	2.7	V
		Falling	2.2	2.4	-	V
Quiescent Supply Current	I_{VIN}	MODE = VIN, no load at the output	-	17	34	μA
		MODE = SGND, no load at the output	-	5	8	mA
Shut Down Supply Current	I_{SD}	VIN = 5.5V, EN = LOW	-	0.05	2	μA
OUTPUT REGULATION						
FB Regulation Voltage	V_{FB}	$T_A = 0^\circ\text{C}$ to $+85^\circ\text{C}$	0.784	0.8	0.816	V
		$T_A = -40^\circ\text{C}$ to $+85^\circ\text{C}$	0.78	0.8	0.82	V
FB Bias Current	I_{FB}	VFB = 0.75V	-	0.1	-	μA
Output Voltage Accuracy		VIN = VO + 0.5V to 5.5V, IO = 0A to 1.2A, TA = -40°C to +85°C	-3	-	3	%
Line Regulation		VIN = VO + 0.5V to 5.5V (minimal 2.7V)	-	0.2	-	%/V
Maximum Output Current			1.2	-	-	A
COMPENSATION						
Error Amplifier Trans-conductance		Design info only	-	20	-	$\mu\text{A/V}$
SW						
P-Channel MOSFET ON-Resistance		VIN = 3.6V, IO = 200mA	-	0.12	0.22	Ω
		VIN = 2.7V, IO = 200mA	-	0.16	0.27	Ω
N-Channel MOSFET ON-Resistance		VIN = 3.6V, IO = 200mA	-	0.11	0.22	Ω
		VIN = 2.7V, IO = 200mA	-	0.15	0.27	Ω
N-Channel Bleeding MOSFET On Resistance				90		Ω
P-Channel MOSFET Peak Current Limit	I_{PK}	VIN = 5.5V	1.5	2.0	2.6	A
Maximum Duty Cycle			-	100	-	%
PWM Switching Frequency	f_S	TA = -40°C to +85°C	1.35	1.6	1.75	MHz
SW Minimum On Time		MODE = LOW (forced PWM mode)	-	-	100	ns
Soft Start-Up Time			-	1.1	-	ms

ISL9106

Electrical Specifications Unless otherwise noted, all parameter limits are guaranteed over the recommended operating conditions and the typical specifications are measured at the following conditions: $T_A = +25^\circ\text{C}$, $V_{IN} = V_{EN} = V_{MODE} = 3.6\text{V}$, $V_{RSI} = 0\text{V}$, $L = 2.2\mu\text{H}$, $C_1 = 10\mu\text{F}$, $C_2 = 10\mu\text{F}$, $I_{OUT} = 0\text{A}$ (see the Typical Application Circuit). **(Continued)**

PARAMETER	SYMBOL	TEST CONDITIONS	MIN	TYP	MAX	UNITS
PG						
Output Low Voltage		Sinking 1mA, VFB = 0.7V	-	-	0.3	V
Delay Time			150	215	275	ms
PG Pin Leakage Current		PG = $V_{IN} = 3.6\text{V}$	-	0.01	0.1	μA
Minimum Supply Voltage for Valid PG Signal			1.2	-	-	V
Internal PGOOD Low Rising Threshold		Percentage of Nominal Regulation Voltage	89.5	92	94.5	%
Internal PGOOD Low Falling Threshold		Percentage of Nominal Regulation Voltage	85	88	91	%
Internal PGOOD High Rising Threshold		Percentage of Nominal Regulation Voltage	108.2	110.7	113.2	%
Internal PGOOD High Falling Threshold		Percentage of Nominal Regulation Voltage	104	107	110	%
Internal PGOOD Delay Time			-	50	-	μs
EN, MODE, RSI						
Logic Input Low			-	-	0.4	V
Logic Input High			1.4	-	-	V
Logic Input Leakage Current		Pulled up to 5.5V	-	0.1	1	μA
Thermal Shutdown			-	150	-	$^\circ\text{C}$
Thermal Shutdown Hysteresis			-	25	-	$^\circ\text{C}$

Typical Operating Performance

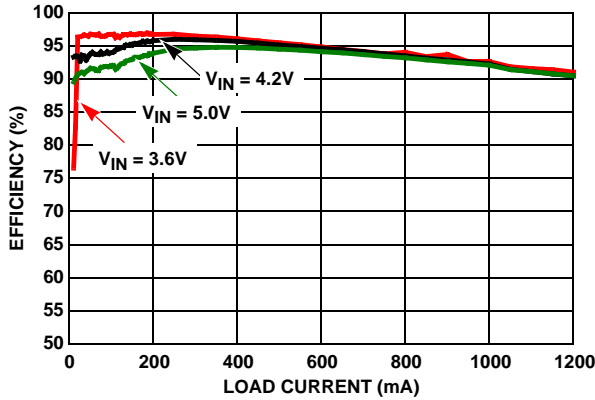

FIGURE 1. EFFICIENCY vs LOAD CURRENT ($V_{OUT} = 3.3V$)

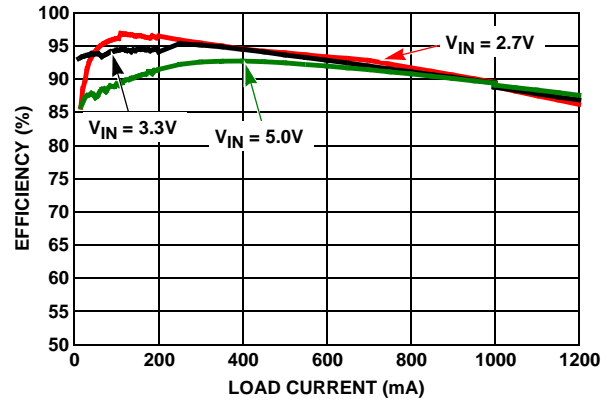

FIGURE 2. EFFICIENCY vs LOAD CURRENT ($V_{OUT} = 2.5V$)

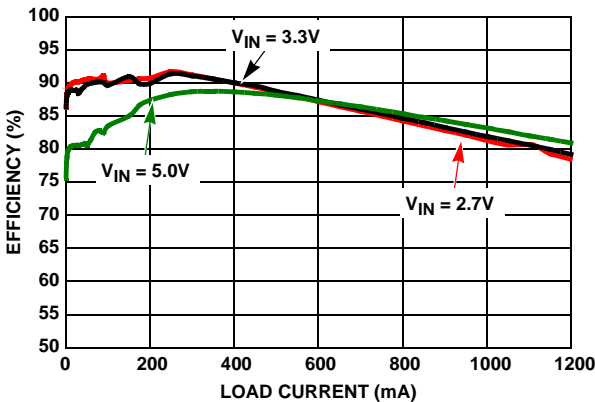

FIGURE 3. EFFICIENCY vs LOAD CURRENT ($V_{OUT} = 1.8V$)

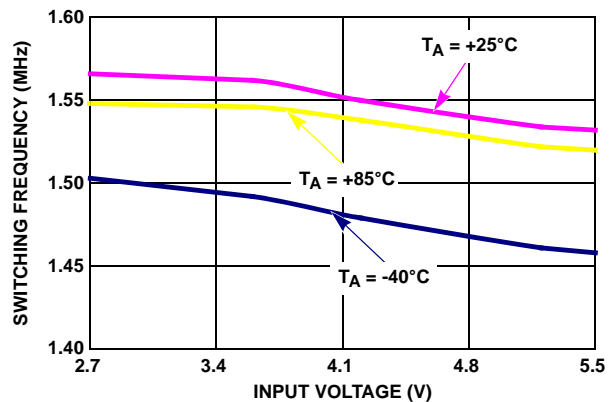

FIGURE 4. SWITCHING FREQUENCY vs INPUT VOLTAGE, ($V_{IN} = 3.6V$, $V_{OUT} = 1.5V$, $I_{OUT} = 600mA$)

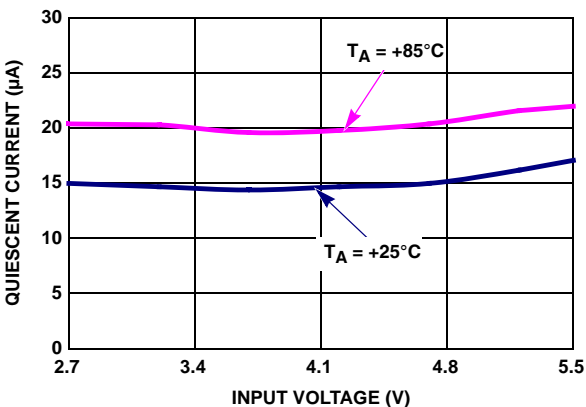

FIGURE 5. I_Q vs V_{IN} (MODE = V_{IN} , $V_{OUT} = 1.5V$, $I_{OUT} = 0$)

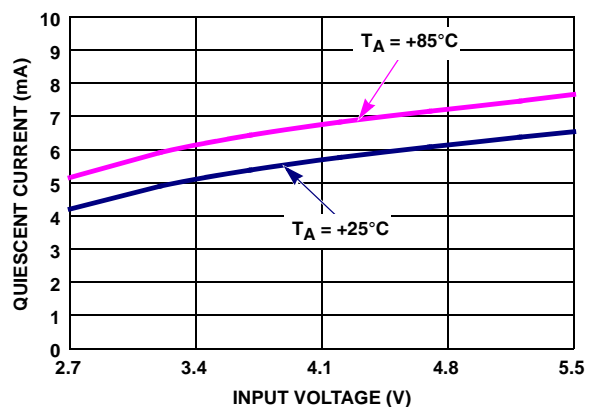

FIGURE 6. I_Q vs V_{IN} (MODE = GND , $V_{OUT} = 1.5V$, $I_{OUT} = 0$)

Typical Operating Performance (Continued)

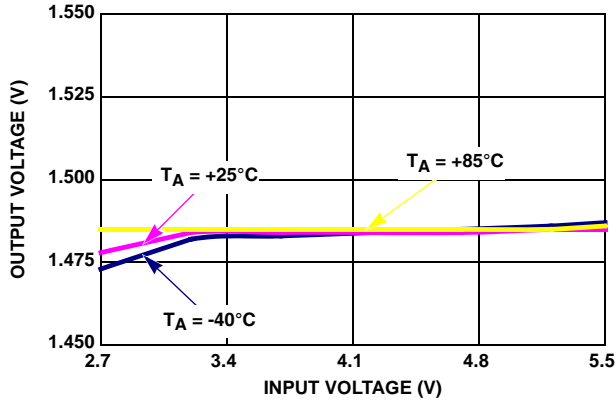

FIGURE 7. V_{OUT} vs V_{IN} (MODE = V_{IN} , V_{OUT} = 1.5V, I_{OUT} = 600mA)

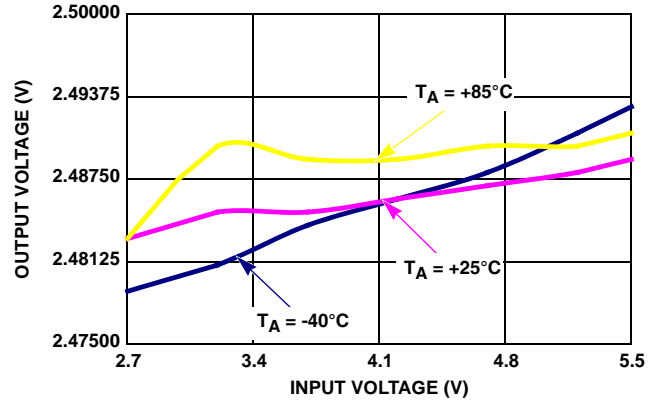

FIGURE 8. V_{OUT} vs V_{IN} (MODE = V_{IN} , V_{OUT} = 2.5V, I_{OUT} = 600mA)

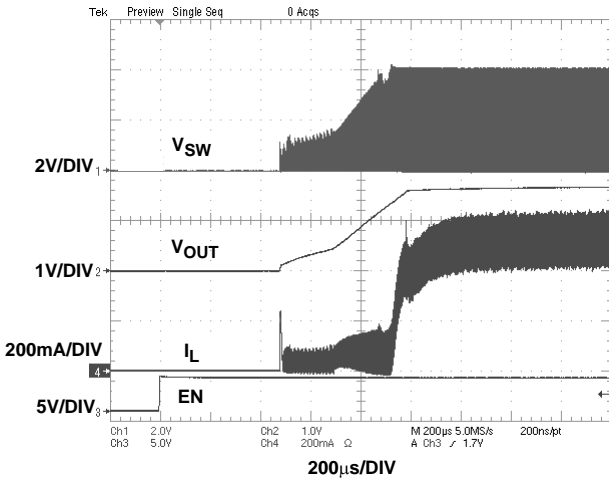

FIGURE 9. SOFT-START TO PWM MODE (V_{IN} = 4.2V, V_{OUT} = 1.6V, I_{OUT} = 500mA)

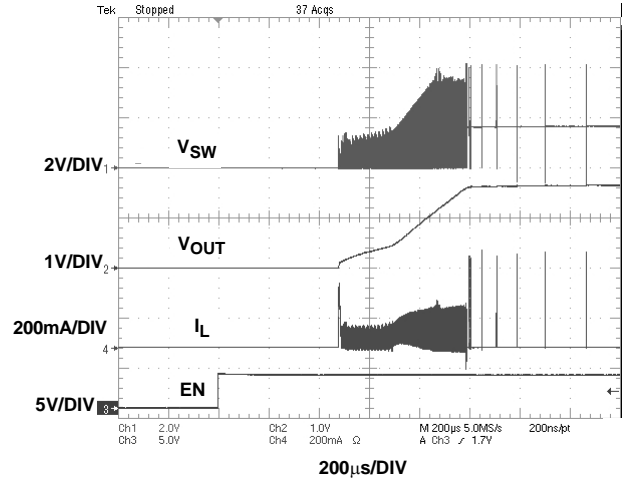

FIGURE 10. SOFT-START TO SKIP MODE (V_{IN} = 4.2V, V_{OUT} = 1.6V, I_{OUT} = 0.01mA)

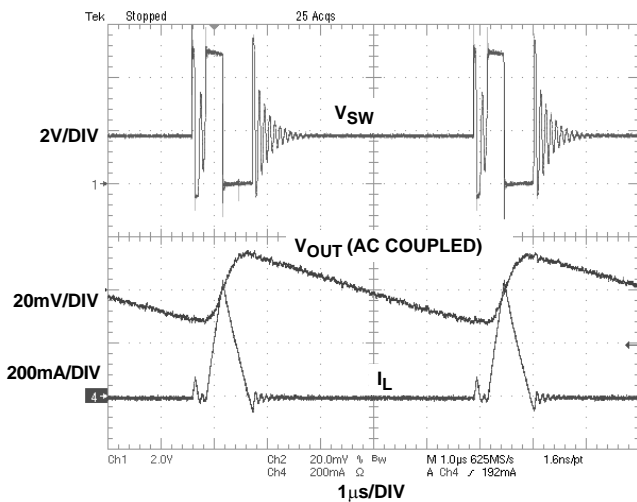

FIGURE 11. STEADY-STATE IN SKIP MODE (V_{IN} = 5.0V, V_{OUT} = 1.8V, I_{OUT} = 35mA)

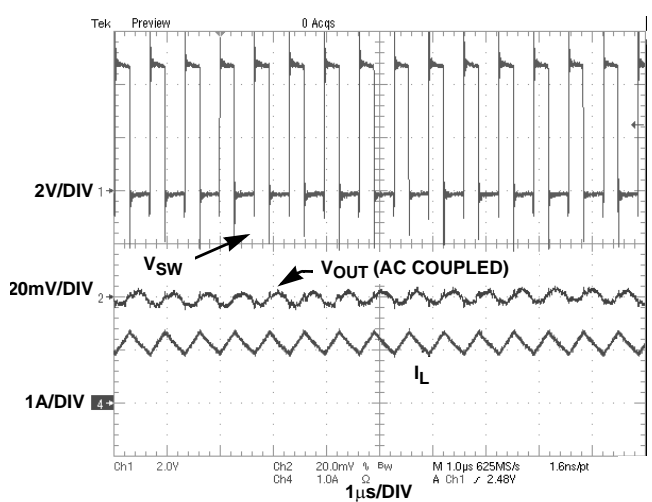

FIGURE 12. STEADY-STATE IN PWM MODE (V_{IN} = 5.0V, V_{OUT} = 1.8V, I_{OUT} = 1.2A)

Typical Operating Performance (Continued)

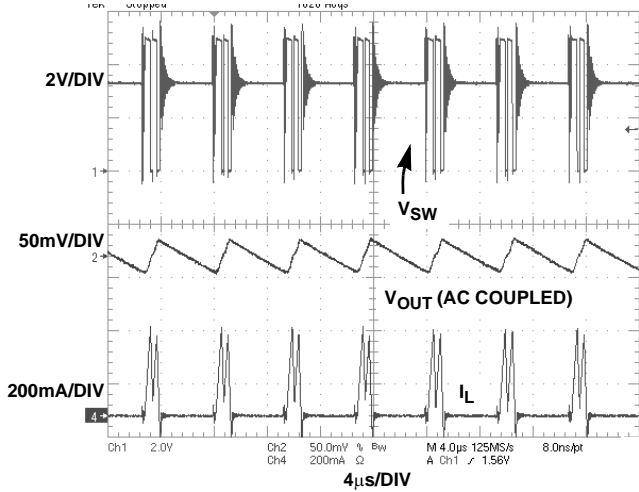

FIGURE 13. STEADY-STATE IN SKIP MODE ($V_{IN} = 5.0V$, $V_{OUT} = 3.3V$, $I_{OUT} = 35mA$)

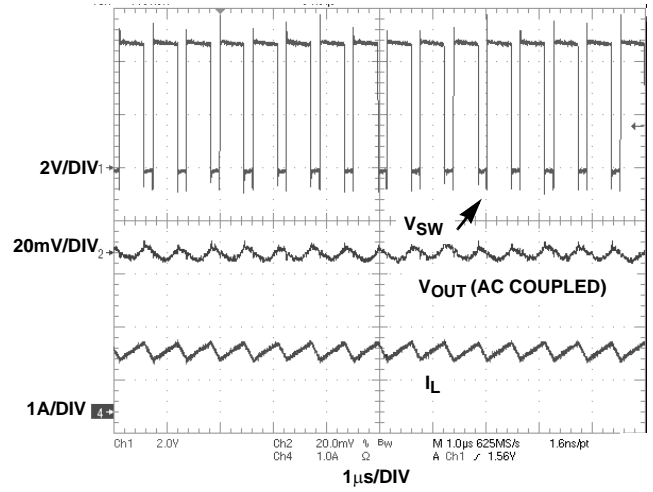

FIGURE 14. STEADY-STATE IN PWM MODE ($V_{IN} = 5.0V$, $V_{OUT} = 3.3V$, $I_{OUT} = 1.2A$)

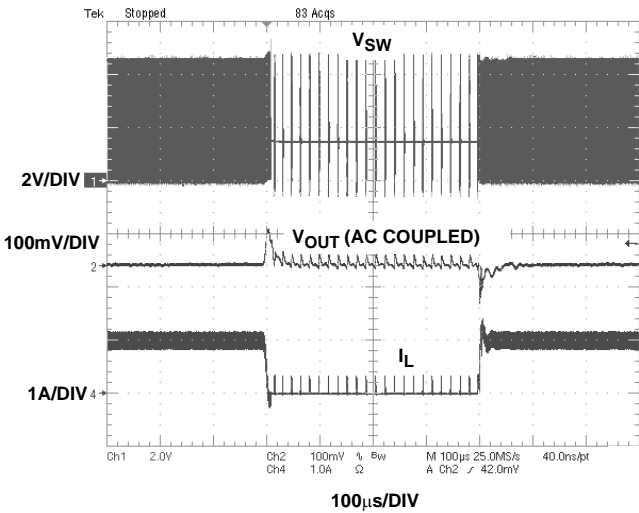

FIGURE 15. LOAD TRANSIENT TEST (MODE = $V_{IN} = 5.0V$; $V_O = 1.5V$; $I_O = 0.01A\sim 1A$)

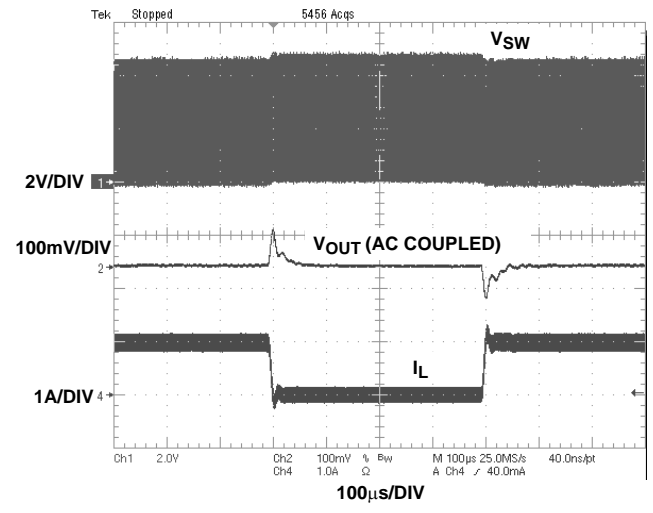

FIGURE 16. LOAD TRANSIENT TEST (MODE = GND, $V_{IN} = 5.0V$; $V_O = 1.5V$; $I_O = 0.01A\sim 1A$)

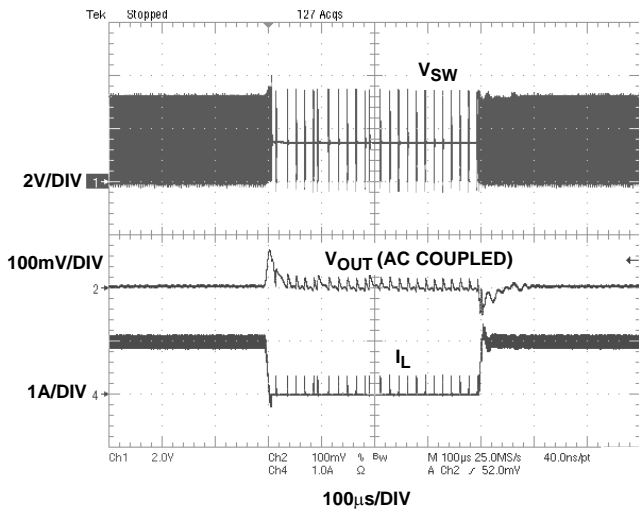

FIGURE 17. LOAD TRANSIENT TEST (MODE = $V_{IN} = 3.6V$; $V_O = 1.5V$; $I_O = 0.01A\sim 1A$)

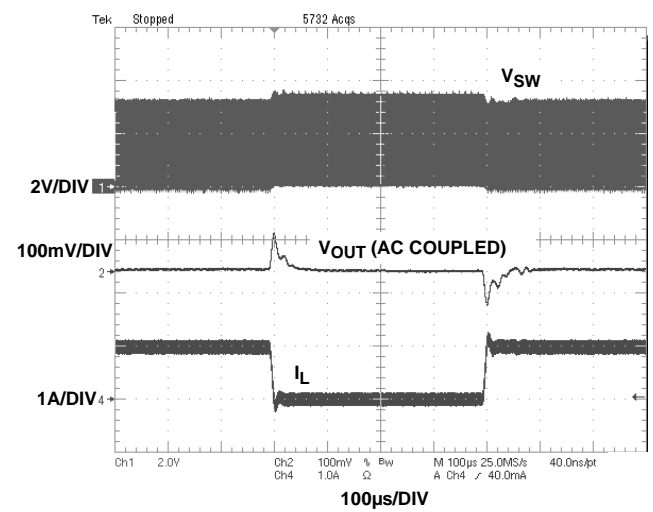

FIGURE 18. LOAD TRANSIENT TEST (MODE = GND, $V_{IN} = 3.6V$; $V_O = 1.5V$; $I_O = 0.01A\sim 1A$)

Typical Operating Performance (Continued)

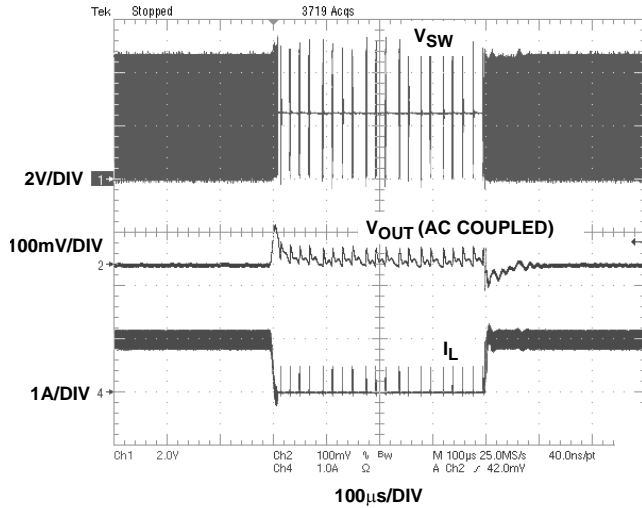

FIGURE 19. LOAD TRANSIENT TEST (MODE = $V_{IN} = 5.0V$;
 $V_O = 2.5V$; $I_O = 0.01A\sim 1A$)

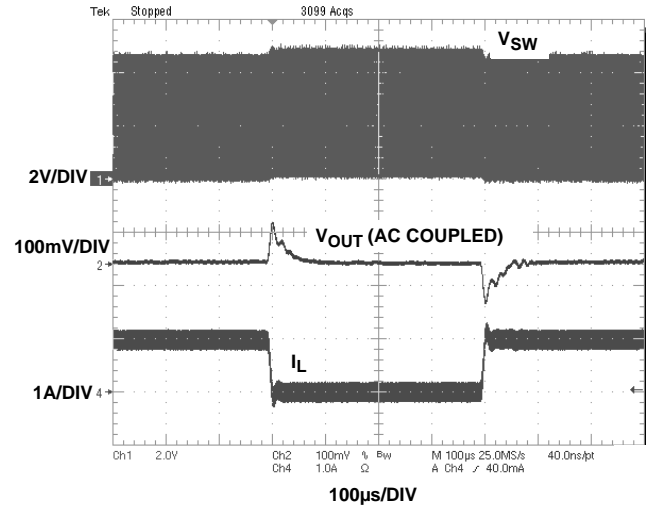

FIGURE 20. LOAD TRANSIENT TEST (MODE = GND,
 $V_{IN} = 5.0V$; $V_O = 2.5V$; $I_O = 0.01A\sim 1A$)

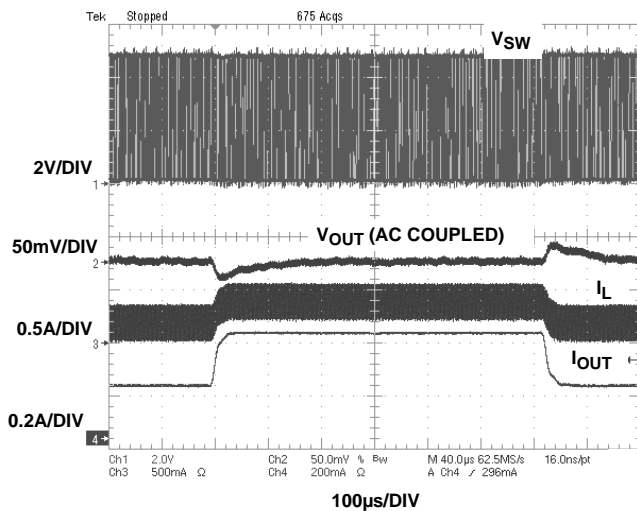

FIGURE 21. LOAD TRANSIENT TEST (MODE = $V_{IN} = 5V$;
 $V_O = 3.3V$; $I_O = 0.2A\sim 0.4A$)

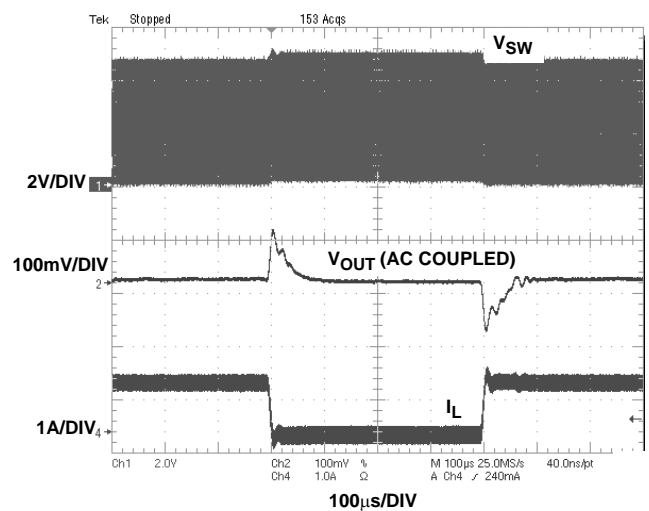

FIGURE 22. LOAD TRANSIENT TEST (MODE = GND,
 $V_{IN} = 5.0V$; $V_O = 3.3V$; $I_O = 0.01A\sim 1A$)

Pin Descriptions

VIN

Input supply voltage. Connect a $10\mu F$ ceramic capacitor to power ground.

NC

No connect.

EN

Enable pin. Enable the device when driven to high. Shut down the chip and discharge output capacitor when driven to low. Do not leave this pin floating.

PG

215ms timer output. This output is a 215ms delayed power-good signal (PG) for the output voltage when output voltage is within the power-good window. It can be reset by a high RSI signal, then 215ms starts when RSI goes from high to low.

MODE

Mode selection pin. Connect to logic high or input voltage V_{IN} for low I_O mode; connect to logic low or ground for forced PWM mode. Do not leave this pin floating.

SW

Switching node connection. Connect to one terminal of inductor.

PGND

Power ground. Connect all power grounds to this pin.

SGND

Analog ground. SGND and PGND should only have one point connection.

FB

Buck regulator output feedback pin. Connect to the output through voltage divider resistor for adjustable output voltage.

RSI

This input resets the 215ms timer. When the output voltage is within the power-good window, an internal timer is started and generates a PG signal 215ms later when RSI is low. A high RSI resets PG and RSI high to low transition restarts the internal counter if the output voltage is within the window, otherwise the counter is reset by the output voltage condition. Do not leave this pin floating.

Exposed Pad

The exposed pad must be connected to the PGND pin for proper electrical performance. The exposed pad must also be connected to as much as possible for optimal thermal performance.

Typical Applications

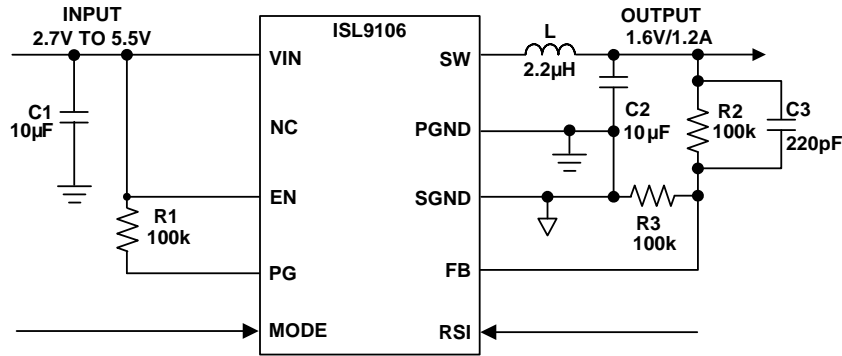

PARTS	DESCRIPTION	MANUFACTURERS	PART NUMBER	SPECIFICATIONS	SIZE
L	Inductor	Sumida	CDRH2D14NP-2R2NC	2.2µH/1.50A/75mΩ	3.2mmx3.2mmx1.55mm
C1	Input capacitor	Murata	GRM21BR60J106KE19L	10µF/6.3V	2.0mmx1.25mmx1.25mm
C2	Output capacitor	Murata	GRM21BR60J106KE19L	10µF/6.3V	2.0mmx1.25mmx1.25mm
C3	Capacitor	Murata	GRM188R71H221KA01C	220pF/50V	1.6mmx0.8mmx0.8mm
R1, R2, R3	Resistor	Various		100kΩ, SMD, 1%	1.6mmx0.8mmx0.45mm

FIGURE 23. TYPICAL APPLICATION DIAGRAM

Block Diagram

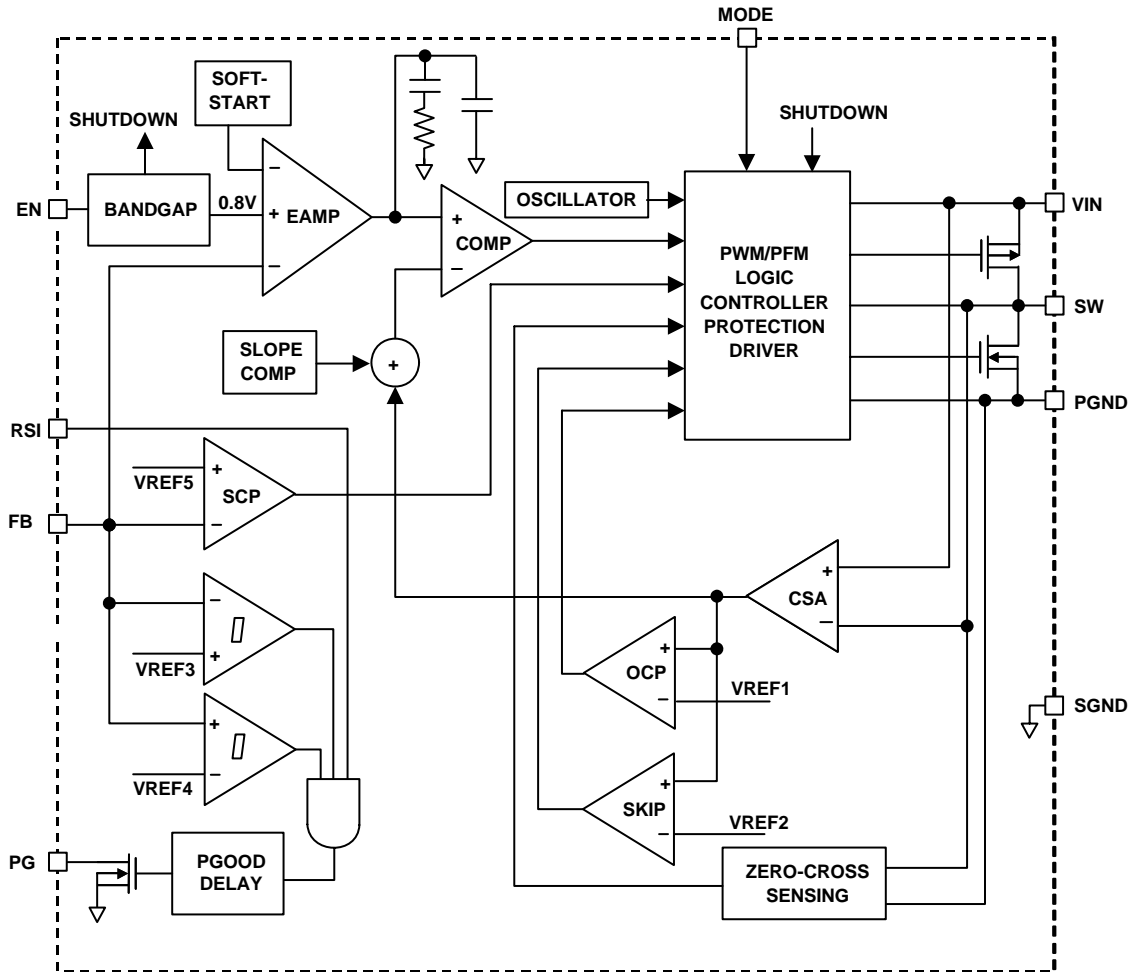

FIGURE 24. FUNCTIONAL BLOCK DIAGRAM

Theory of Operation

The ISL9106 is a step-down switching regulator optimized for battery-powered handheld applications. The regulator operates at typical 1.6MHz fixed switching frequency under heavy load condition to allow small external inductor and capacitors to be used for minimal printed-circuit board (PCB) area. At light load, the regulator can be selected to enter skip mode to reduce the switching frequency, unless forced to the fixed frequency, to minimize the switching loss and to maximize the battery life. The quiescent current under skip mode with no loading is typically only 17 μ A. The supply current is typically only 0.1 μ A when the regulator is disabled.

PWM Control Scheme

The ISL9106 uses the peak-current-mode pulse-width modulation (PWM) control scheme for fast transient response and pulse-by-pulse current limiting. Figure 24 shows the circuit functional block diagram. The current loop consists of the oscillator, the PWM comparator COMP,

current sensing circuit, and the slope compensation for the current loop stability. The current sensing circuit consists of the resistance of the P-Channel MOSFET when it is turned on and the Current Sense Amplifier (CSA). The control reference for the current loops comes from the Error Amplifier (EAMP) of the voltage loop.

The PWM operation is initialized by the clock from the oscillator. The P-Channel MOSFET is turned on at the beginning of a PWM cycle and the current in the P-Channel MOSFET starts ramping up. When the sum of the CSA output and the compensation slope reaches the control reference of the current loop, the PWM comparator COMP sends a signal to the PWM logic to turn off the P-Channel MOSFET and to turn on the N-Channel MOSFET. The N-MOSFET remains on till the end of the PWM cycle. Figure 25 shows the typical operating waveforms during the normal PWM operation. The dotted lines illustrate the sum of the slope compensation ramp and the CSA output.

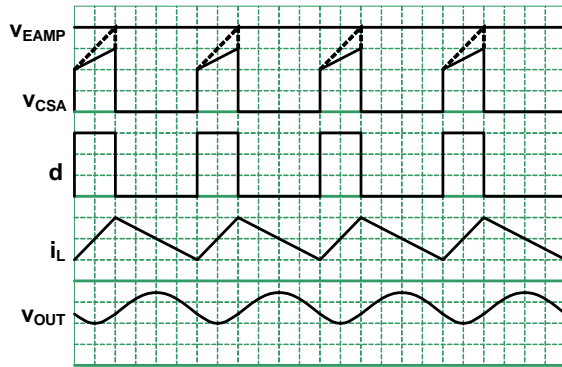

FIGURE 25. PWM OPERATION WAVEFORMS

The output voltage is regulated by controlling the reference voltage to the current loop. The bandgap circuit outputs a 0.8V reference voltage to the voltage control loop. The feedback signal comes from the FB pin. The soft-start block only affects the operation during the start-up and will be discussed separately in “Soft-Start-Up” on page 11. The EAMP is a transconductance amplifier, which converts the voltage error signal to a current output. The voltage loop is internally compensated by a RC network. The maximum EAMP voltage output is precisely clamped to the bandgap voltage.

Skip Mode

With the MODE pin connected to logic high, ISL9106 enters a pulse-skipping mode at light load to minimize the switching loss by reducing the switching frequency. Figure 26 illustrates the skip mode operation. A zero-cross sensing circuit (as shown in Figure 24) monitors the N-Channel MOSFET current for zero crossing. When it is detected to cross zero for 8 consecutive cycles, the regulator enters the skip mode. During the 8 consecutive cycles, the inductor current could be negative. The counter is reset to zero when the sensed N-Channel MOSFET current does not cross zero during any cycle within the 8 consecutive cycles.

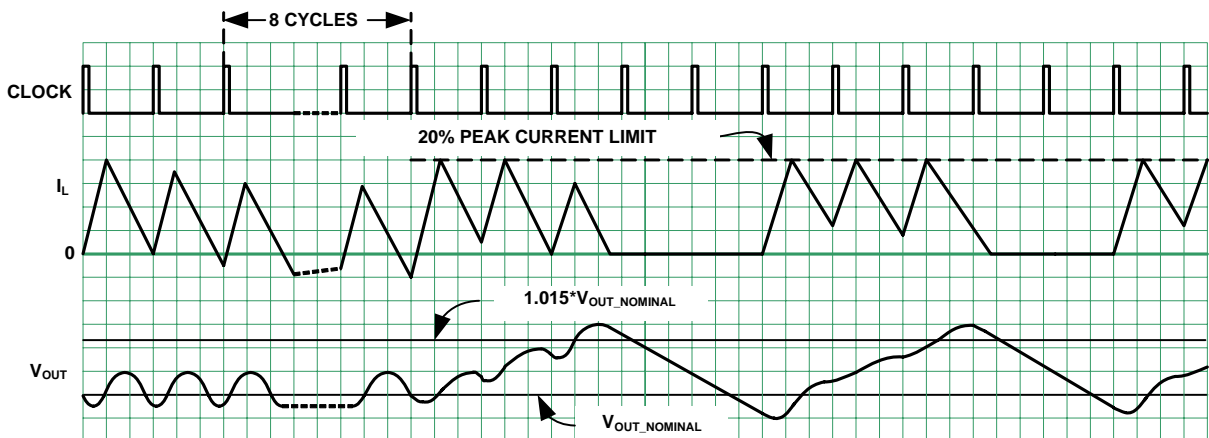

FIGURE 26. SKIP MODE OPERATION WAVEFORMS

Once ISL9106 enters the skip mode, the pulse modulation starts being controlled by the SKIP comparator shown in Figure 24. Each pulse cycle is still synchronized by the PWM clock. The P-Channel MOSFET is turned on at the rising edge of clock and turned off when its current reaches 20% of the peak current limit. As the average inductor current in each cycle is higher than the average current of the load, the output voltage rises cycle over cycle. When the output voltage reaches 1.5% above its nominal voltage, the P-Channel MOSFET is turned off immediately and the inductor current is fully discharged to zero and stays at zero. The output voltage reduces gradually due to the load current discharging the output capacitor. When the output voltage drops to the nominal voltage, the P-Channel MOSFET will be turned on again, repeating the previous operations.

The regulator resumes normal PWM mode operation when the output voltage is sensed to drop below 1.5% of its nominal voltage value.

Enable

The enable (EN) pin allows user to enable or disable the converter for purposes such as power-up sequencing. With EN pin pulled to high, the converter is enabled and the internal reference circuit wakes up first and then the soft start-up begins. When EN pin is pulled to logic low, the converter is disabled, the P-Channel MOSFET is turned off immediately and the output capacitor is discharged through internal discharge path.

Power Good

The ISL9106 offers a power-good (PG) signal. When the output voltage is not within the power-good window, the PG pin outputs an open-drain low signal. When the output voltage is within the power-good window, an internal power-good signal is issued to turn off the open-drain MOSFET so that PG pin can be externally pulled to high. The rising edge of the PG output is delayed by 215ms (typical) from the time the power-good signal is issued.

Mode Selection

The MODE pin is provided on ISL9106 to select the operation mode. When it is driven to logic low or ground, the regulator operates in forced PWM mode. Under forced PWM mode, the device remains at the fixed PWM operation (typical at 1.6MHz), regardless of if the load current is high or low.

When the MODE pin is driven to logic high or connected to input voltage V_{IN} , the regulator operates in either SKIP mode or fixed PWM mode depending on the different load conditions.

RSI Signal

The RSI signal is an input signal, which can reset the PG signal. As shown in Figure 24, the power-good signal is gated by the RSI signal. When the RSI is high, the PG signal remains low, regardless of the output voltage condition.

Overcurrent Protection

The overcurrent protection is provided on ISL9106 when over load condition happens. It is realized by monitoring the CSA output with the OCP comparator, as shown in Figure 24. When the current at P-Channel MOSFET is sensed to reach the current limit, the OCP comparator is triggered to turn off the P-Channel MOSFET immediately.

Short-Circuit Protection

ISL9106 has a Short-Circuit Protection (SCP) comparator, which monitors the FB pin voltage for output short-circuit protection. When the FB voltage is lower than 0.2V, the SCP comparator forces the PWM oscillator frequency to drop to 1/3 of its normal operation frequency.

Undervoltage Lockout (UVLO)

When the input voltage is below the Undervoltage Lock Out (UVLO) threshold, ISL9106 is disabled.

Soft-Start-Up

The soft-start-up eliminates the inrush current during the circuit start-up. The soft-start block outputs a ramp reference to both the voltage loop and the current loop. The two ramps limit the inductor current rising speed as well as the output voltage speed so that the output voltage rises in a controlled fashion. At the very beginning of the start-up, the output voltage is less than 0.2V; hence the PWM operating frequency is 1/3 of the normal frequency.

Power MOSFETs

The power MOSFETs are optimized to achieve better efficiency. The ON-resistance for the P-Channel MOSFET is typically 160m Ω and the typical ON-resistance for the N-Channel MOSFET is 150m Ω .

Low Dropout Operation

The ISL9106 features low dropout operation to maximize the battery life. When the input voltage drops to a level that ISL9106 can no longer operate under switching regulation to

maintain the output voltage, the P-Channel MOSFET is completely turned on (100% duty cycle). The dropout voltage under such condition is the product of the load current and the ON-resistance of the P-Channel MOSFET. Minimum required input voltage V_{IN} under this condition is the sum of output voltage plus the voltage drop across the inductor and the P-Channel MOSFET switch.

Thermal Shut Down

The ISL9106 provides built-in thermal protection function. The thermal shutdown threshold temperature is typical +150°C with typical +25°C hysteresis. When the internal temperature is sensed to reach +150°C, the regulator is completely shut down and as the temperature is sensed to drop to +125°C (typical), the ISL9106 resumes operation starting from the soft-start-up.

Applications Information

Inductor and Output Capacitor Selection

To achieve better steady state and transient response, ISL9106 typically uses a 2.2 μ H inductor. The peak-to-peak inductor current ripple can be expressed as follows:

$$\Delta I = \frac{V_O \cdot \left(1 - \frac{V_O}{V_{IN}}\right)}{L \cdot f_S} \quad (\text{EQ. 1})$$

In Equation 1, usually the typical values can be used but to have a more conservative estimation, the inductance should consider the value with worst case tolerance; and for switching frequency f_S , the minimum f_S from the "Electrical Specifications" table on page 2 can be used.

To select the inductor, its saturation current rating should be at least higher than the sum of the maximum output current and half of the delta calculated from Equation 1. Another more conservative approach is to select the inductor with the current rating higher than the P-Channel MOSFET peak current limit.

Another consideration is the inductor DC resistance since it directly affects the efficiency of the converter. Ideally, the inductor with the lower DC resistance should be considered to achieve higher efficiency.

Inductor specifications could be different from different manufacturers so please check with each manufacturer if additional information is needed.

For the output capacitor, a ceramic capacitor can be used because of the low ESR values, which helps to minimize the output voltage ripple. A typical value of 10 μ F/6.3V ceramic capacitor should be enough for most of the applications and the capacitor should be X5R or X7R.

Input Capacitor Selection

The main function for the input capacitor is to provide decoupling of the parasitic inductance and to provide filtering function to prevent the switching current from flowing back to the battery rail. A 10 μ F/6.3V ceramic capacitor (X5R or X7R) is a good starting point for the input capacitor selection.

Output Voltage Setting Resistor Selection

The voltage divider resistors, R₂ and R₃, as shown in Figure 23, set the desired output voltage value. The output voltage can be calculated using Equation 2:

$$V_O = V_{FB} \cdot \left(1 + \frac{R_2}{R_3} \right) \quad (\text{EQ. 2})$$

where V_{FB} is the feedback voltage (typically it is 0.8V). The current flowing through the voltage divider resistors can be calculated as V_O/(R₂ + R₃), so larger resistance is desirable to minimize this current. On the other hand, the FB pin has leakage current that will cause error in the output voltage setting. The leakage current has a typical value of 0.1 μ A. To minimize the accuracy impact on the output voltage, select the R₃ no larger than 200k Ω .

C₃ (shown in Figure 23) is highly recommended to be added for improving stability and achieving better transient response. C₃ can be calculated using Equation 3:

$$C_3 = \frac{1}{2 \times \pi \times R_2 \times 7.3\text{kHz}} \quad (\text{EQ. 3})$$

Table 1 provides the recommended component values for some output voltage options.

Layout Recommendation

The PCB layout is a very important converter design step to make sure the designed converter works well, especially under the high current high switching frequency condition.

For ISL9106, the power loop is composed of the output inductor L, the output capacitor C_{OUT}, the SW pin and the PGND pin. It is necessary to make the power loop as small as possible and the connecting traces among them should be direct, short and wide; the same type of traces should be used to connect the VIN pin, the input capacitor C_{IN} and its ground. In order to make the output voltage regulate well and avoid the noise couple from the power loop (especially for SKIP mode operation), the SGND pin should be connected with the PGND pin at the terminals of the load and a star ground connection should be used.

The switching node of the converter, the SW pin, and the traces connected to this node are very noisy, so keep the voltage feedback trace and other noise sensitive traces away from these noisy traces.

The input capacitor should be placed as close as possible to the VIN pin. The ground of the input and output capacitors should be connected as close as possible as well.

The heat of the IC is mainly dissipated through the thermal pad. Maximizing the copper area connected to the thermal pad is preferable. In addition, a solid ground plane is helpful for EMI performance.

TABLE 1. ISL9106 CIRCUIT CONFIGURATION vs V_{OUT}

VOUT (V)	L (μ H)	C2 (μ F)	R2 (k Ω)	C3 (pF)	R3 (k Ω)
0.8	2.2	10	0	N/A	100
1.0	2.2	10	44.2	470	178
1.2	2.2	10	80.6	270	162
1.5	2.2	10	84.5	270	97.6
1.8	2.2	10	100	220	80.6
2.5	2.2	10	100	220	47.5
2.8	2.2	10	100	220	40.2
3.3	2.2	10	102	220	32.4

Dual Flat No-Lead Plastic Package (DFN)

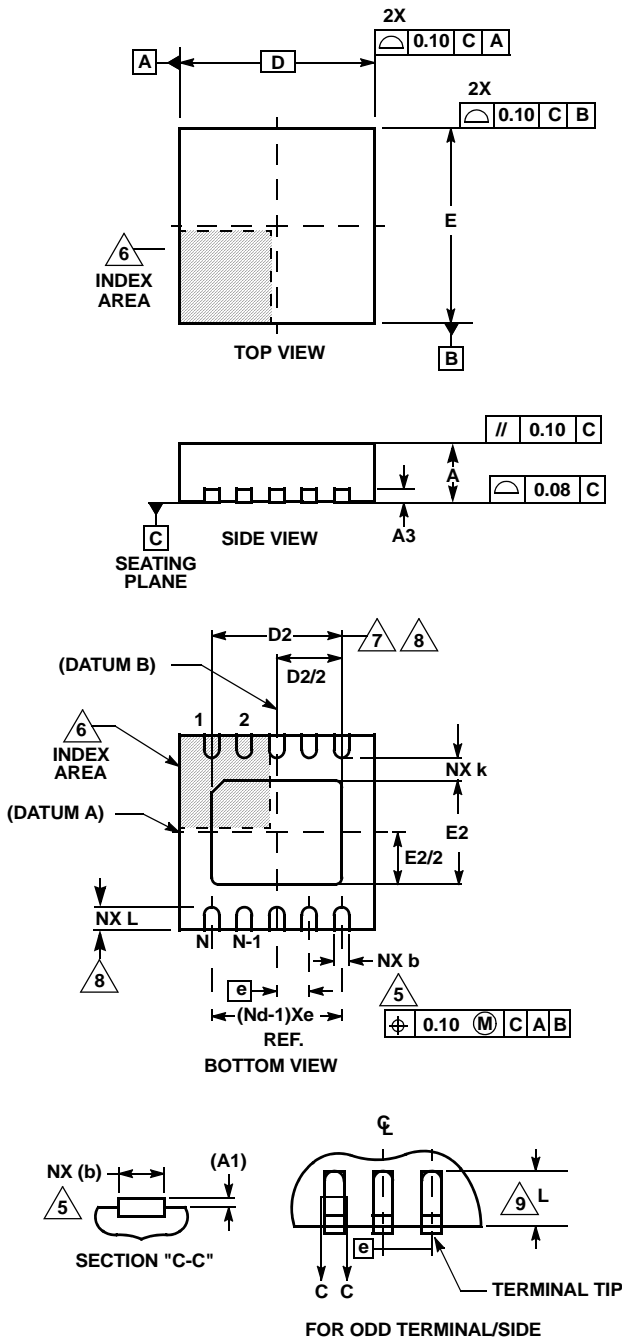

L10.3x3C
10 LEAD DUAL FLAT NO-LEAD PLASTIC PACKAGE

SYMBOL	MILLIMETERS			NOTES
	MIN	NOMINAL	MAX	
A	0.85	0.90	0.95	-
A1	-	-	0.05	-
A3	0.20 REF			-
b	0.20	0.25	0.30	5, 8
D	3.00 BSC			-
D2	2.33	2.38	2.43	7, 8
E	3.00 BSC			-
E2	1.59	1.64	1.69	7, 8
e	0.50 BSC			-
k	0.20	-	-	-
L	0.35	0.40	0.45	8
N	10			2
Nd	5			3

Rev. 1 4/06

NOTES:

1. Dimensioning and tolerancing conform to ASME Y14.5-1994.
2. N is the number of terminals.
3. Nd refers to the number of terminals on D.
4. All dimensions are in millimeters. Angles are in degrees.
5. Dimension b applies to the metallized terminal and is measured between 0.15mm and 0.30mm from the terminal tip.
6. The configuration of the pin #1 identifier is optional, but must be located within the zone indicated. The pin #1 identifier may be either a mold or mark feature.
7. Dimensions D2 and E2 are for the exposed pads which provide improved electrical and thermal performance.
8. Nominal dimensions are provided to assist with PCB Land Pattern Design efforts, see Intersil Technical Brief TB389.
9. COMPLIANT TO JEDEC MO-229-WEED-3 except for dimensions E2 & D2.

All Intersil U.S. products are manufactured, assembled and tested utilizing ISO9000 quality systems. Intersil Corporation's quality certifications can be viewed at www.intersil.com/design/quality

Intersil products are sold by description only. Intersil Corporation reserves the right to make changes in circuit design, software and/or specifications at any time without notice. Accordingly, the reader is cautioned to verify that data sheets are current before placing orders. Information furnished by Intersil is believed to be accurate and reliable. However, no responsibility is assumed by Intersil or its subsidiaries for its use; nor for any infringements of patents or other rights of third parties which may result from its use. No license is granted by implication or otherwise under any patent or patent rights of Intersil or its subsidiaries.

For information regarding Intersil Corporation and its products, see www.intersil.com