

Rad Hard Dual 36V Precision Single-Supply, Rail-to-Rail Output, Low-Power Operational Amplifiers

ISL70218SRH

The ISL70218SRH is a dual, low-power precision amplifier optimized for single-supply applications. This op amp features a common mode input voltage range extending to 0.5V below the V- rail, a rail-rail differential input voltage range, and rail-to-rail output voltage swing, which makes it ideal for single-supply applications where input operation at ground is important.

This op amp features low power, low offset voltage, and low temperature drift, making it ideal for applications requiring both high DC accuracy and AC performance. This amplifier is designed to operate over a single supply range of 3V to 36V or a split supply voltage range of +1.8V/-1.2V to ±18V. The combination of precision and small footprint provides the user with outstanding value and flexibility relative to similar competitive parts.

Applications for this amplifier include precision instrumentation, data acquisition, precision power supply controls, and industrial controls.

The ISL70218SRH is available in a 10 Ld hermetic ceramic flatpack and operates over the extended temperature range of -55 °C to +125 °C.

Related Literature

- See [AN1653](#), "ISL70218SRH Evaluation Board User's Guide"

Features

- Wide Single and Dual Supply Range 3V to 36V Max.
- Low Current Consumption 850µA, Typ.
- Low Input Offset Voltage 40µV, Typ.
- Rail-to-Rail Output <10mV
- Rail-to-Rail Input Differential Voltage Range for Comparator Applications
- Operating Temperature Range -55 °C to +125 °C
- Below-ground (V-) Input Capability to -0.5V.
- Low Noise Voltage 5.6nV/√Hz, Typ.
- Low Noise Current 355fA/√Hz, Typ.
- Offset Voltage Temperature Drift 0.3µV/°C, Typ.
- No Phase Reversal
- Radiation Tolerance
 - High Dose Rate 100krad(Si)
 - Low Dose Rate 100krad(Si)
 - SEL/SEB LET_{TH} (V_S = ±18V) 86.4 MeV/mg/cm²

Applications

- Precision Instruments
- Active Filter Blocks
- Data Acquisition
- Power Supply Control
- Industrial Process Control

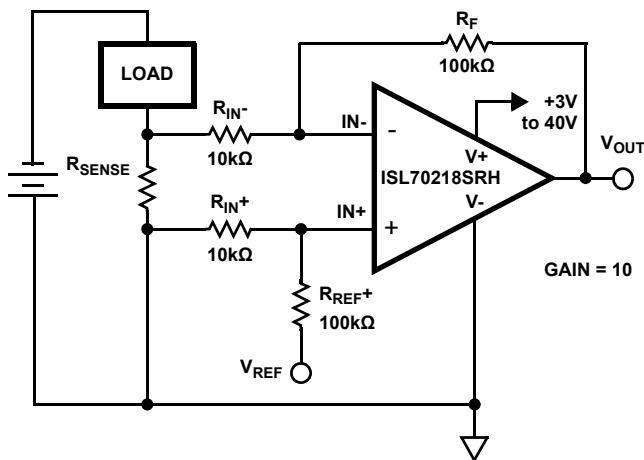

FIGURE 1. TYPICAL APPLICATION: SINGLE-SUPPLY, LOW-SIDE CURRENT SENSE AMPLIFIER

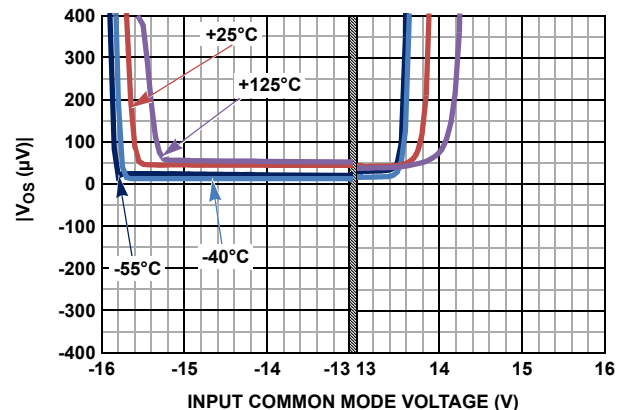
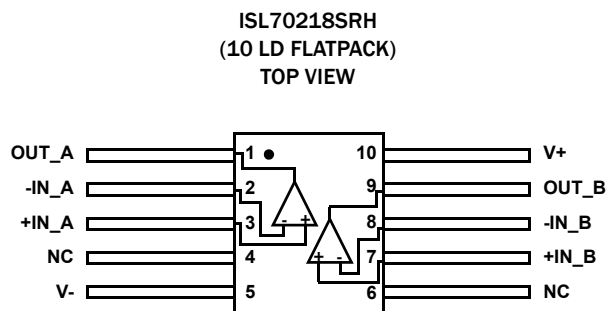

FIGURE 2. INPUT OFFSET VOLTAGE vs INPUT COMMON MODE VOLTAGE, V_S = ±15V

ISL70218SRH

Pin Configurations



Pin Descriptions

PIN NUMBER	PIN NAME	EQUIVALENT CIRCUIT	DESCRIPTION
1	OUT_A	Circuit 2	Amplifier A output
2	-IN_A	Circuit 1	Amplifier A inverting input
3	+IN_A	Circuit 1	Amplifier A non-inverting input
4	NC		No connect
5	V-	Circuit 1, 2, 3	Negative power supply
6	NC		No connect
7	+IN_B	Circuit 1	Amplifier B non-inverting input
8	-IN_B	Circuit 1	Amplifier B inverting input
9	OUT_B	Circuit 2	Amplifier B output
10	V+	Circuit 1, 2, 3	Positive power supply

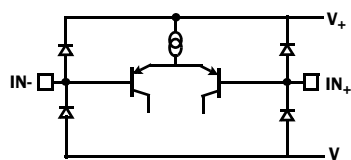

CIRCUIT 1

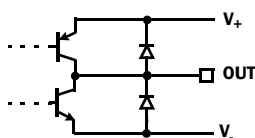

CIRCUIT 2

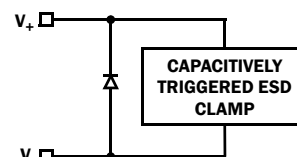

CIRCUIT 3

Ordering Information

ORDERING NUMBER	PART NUMBER	TEMP RANGE (°C)	PACKAGE	PKG. DWG. #
ISL70218SRHMF	ISL70218 SRHMF	-55 to +125	10 Ld Flatpack	K10.A
ISL70218SRHF/PROTO	ISL70218 SRHF /PROTO	-55 to +125	10 Ld Flatpack	K10.A
ISL70218SRHMX		-55 to +125	DIE	
ISL70218SRHX/SAMPLE		-55 to +125	DIE	
ISL70218SRHMEVAL1Z	Evaluation Board			

NOTES:

1. These Intersil Pb-free Hermetic packaged products employ 100% Au plate - e4 termination finish, which is RoHS compliant and compatible with both SnPb and Pb-free soldering operations.
2. For Moisture Sensitivity Level (MSL), please see device information page for [ISL70218SRH](#). For more information on MSL, please see Tech Brief [TB363](#).

ISL70218SRH

Absolute Maximum Ratings

Maximum Supply Voltage	36V
Maximum Differential Input Current	20mA
Maximum Differential Input Voltage	36V or $V_- - 0.5V$ to $V_+ + 0.5V$
Min/Max Input Voltage	36V or $V_- - 0.5V$ to $V_+ + 0.5V$
Max/Min Input Current	$\pm 20mA$
Output Short-Circuit Duration (1 output at a time)	Indefinite
ESD Tolerance	
Human Body Model (Tested per MIL-PRF-883 3015.7)	3kV
Machine Model (Tested per JESD22-A115-A)	300V
Charged Device Model (Tested per CDM-22C10ID)	2kV

Thermal Information

Thermal Resistance (Typical)	θ_{JA} ($^{\circ}C/W$)	θ_{JC} ($^{\circ}C/W$)
10 Ld Flatpack Package (Notes 3, 4)	130	20
Storage Temperature Range	-65 $^{\circ}C$ to +150 $^{\circ}C$	

Recommended Operating Conditions

Ambient Operating Temperature Range	-55 $^{\circ}C$ to +125 $^{\circ}C$
Maximum Operating Junction Temperature	+150 $^{\circ}C$
Supply Voltage	3V (+1.8V/-1.2V) to 30V ($\pm 15V$)

CAUTION: Do not operate at or near the maximum ratings listed for extended periods of time. Exposure to such conditions may adversely impact product reliability and result in failures not covered by warranty.

NOTES:

- θ_{JA} is measured with the component mounted on a low effective thermal conductivity test board in free air. See Tech Brief [TB379](#) for details.
- For θ_{JC} , the "case temp" location is the center of the package underside.

Electrical Specifications $V_S \pm 15V$, $V_{CM} = 0$, $V_O = 0V$, $R_L = \text{Open}$, $T_A = +25^{\circ}C$, unless otherwise noted. **Boldface limits apply over the operating temperature range, -55 $^{\circ}C$ to +125 $^{\circ}C$.**

PARAMETER	DESCRIPTION	CONDITIONS	MIN (Note 5)	TYP	MAX (Note 5)	UNIT
V_{OS}	Offset Voltage			40	230	μV
					290	μV
TCV_{OS}	Offset Voltage Drift			0.3	1.4	$\mu V/^{\circ}C$
ΔV_{OS}	Input Offset Voltage Match			44	280	μV
					365	μV
I_{OS}	Input Offset Current		-50	4	50	nA
			-75		75	nA
I_B	Input Bias Current		-575	-230		nA
			-800			nA
V_{CMIR}	Common Mode Input Voltage Range	Guaranteed by CMRR Test	(V-) - 0.5		(V+) + 1.8	V
			V-		(V+) - 1.8	V
CMRR	Common-Mode Rejection Ratio	$V_{CM} = V_-$ to $V_+ - 1.8V$	100	118		dB
		$V_{CM} = V_+$ to $V_- - 1.8V$	97			dB
PSRR	Power Supply Rejection Ratio	$V_S = 3V$ to 40V, $V_{CMIR} = \text{Valid Input Voltage}$	105	124		dB
			100	-		dB
A_{VOL}	Open-Loop Gain	$R_L = 10k\Omega$ to ground $V_O = -13V$ to +13V	120	130		dB
			115			dB
V_{OH}	Output Voltage High, V_+ to V_{OUT}	$R_L = 10k\Omega$			110	mV
					120	mV
V_{OL}	Output Voltage Low, V_{OUT} to V_-	$R_L = 10k\Omega$			70	mV
					80	mV
I_S	Supply Current/Amplifier			0.85	1.1	mA
					1.4	mA
I_{S+}	Source Current Capability		10			mA
I_{S-}	Sink Current Capability		10			mA
V_{SUPPLY}	Supply Voltage Range	Guaranteed by PSRR	3		40	V

ISL70218SRH

Electrical Specifications $V_S \pm 15V$, $V_{CM} = 0$, $V_O = 0V$, $R_L = \text{Open}$, $T_A = +25^\circ\text{C}$, unless otherwise noted. **Boldface limits apply over the operating temperature range, -55°C to $+125^\circ\text{C}$.** (Continued)

PARAMETER	DESCRIPTION	CONDITIONS	MIN (Note 5)	TYP	MAX (Note 5)	UNIT
AC SPECIFICATIONS						
GBW	Gain Bandwidth Product	$A_{CL} = 101$, $V_{OUT} = 100mV_{P-P}$; $R_L = 2k$		4		MHz
e_{n-p-p}	Voltage Noise	0.1Hz to 10Hz, $V_S = \pm 18V$		300		nV _{P-P}
e_n	Voltage Noise Density	$f = 10\text{Hz}$, $V_S = \pm 18V$		8.5		nV/ $\sqrt{\text{Hz}}$
e_n	Voltage Noise Density	$f = 100\text{Hz}$, $V_S = \pm 18V$		5.8		nV/ $\sqrt{\text{Hz}}$
e_n	Voltage Noise Density	$f = 1\text{kHz}$, $V_S = \pm 18V$		5.6		nV/ $\sqrt{\text{Hz}}$
e_n	Voltage Noise Density	$f = 10\text{kHz}$, $V_S = \pm 18V$		5.6		nV/ $\sqrt{\text{Hz}}$
i_n	Current Noise Density	$f = 1\text{kHz}$, $V_S = \pm 18V$		355		fA/ $\sqrt{\text{Hz}}$
THD + N	Total Harmonic Distortion + Noise	1kHz, $G = 1$, $V_O = 3.5V_{RMS}$, $R_L = 10k\Omega$		0.0003		%
TRANSIENT RESPONSE						
SR	Slew Rate	$A_V = 1$, $R_L = 2k\Omega$, $V_O = 10V_{P-P}$		± 1.2		V/ μs
t_r , t_f , Small Signal	Rise Time 10% to 90% of V_{OUT}	$A_V = 1$, $V_{OUT} = 100mV_{P-P}$, $R_f = 0\Omega$, $R_L = 2k\Omega$ to V_{CM}		100		ns
	Fall Time 90% to 10% of V_{OUT}	$A_V = 1$, $V_{OUT} = 100mV_{P-P}$, $R_f = 0\Omega$, $R_L = 2k\Omega$ to V_{CM}		100		ns
t_s	Settling Time to 0.01% 10V Step; 10% to V_{OUT}	$A_V = 1$, $V_{OUT} = 10V_{P-P}$, $R_f = 0\Omega$, $R_L = 2k\Omega$ to V_{CM}		8.5		μs

Electrical Specifications $V_S \pm 5V$, $V_{CM} = 0$, $V_O = 0V$, $T_A = +25^\circ\text{C}$, unless otherwise noted. **Boldface limits apply over the operating temperature range, -55°C to $+125^\circ\text{C}$.**

PARAMETER	DESCRIPTION	CONDITIONS	MIN (Note 5)	TYP	MAX (Note 5)	UNIT
V_{OS}	Offset Voltage			40		μV
ΔV_{OS}	Input Offset Voltage Match			44		μV
I_{OS}	Input Offset Current			4		nA
I_B	Input Bias Current			-230		nA
V_{CMIR}	Common Mode Input Voltage Range	Guaranteed by CMRR Test	(V-) - 0.5		(V+) + 1.8	V
			V-		(V+) - 1.8	V
CMRR	Common-Mode Rejection Ratio	$V_{CM} = V_- - 0.5V$ to $V_+ - 1.8$ $V_{CM} = V_-$ to $V_+ - 1.8V$		117		dB
PSRR	Power Supply Rejection Ratio	$V_S = 3V$ to $40V$, $V_{CMIR} = \text{Valid Input Voltage}$		124		dB
A_{VOL}	Open-Loop Gain	$R_L = 10k\Omega$ to ground $V_O = -3V$ to $+3V$		130		dB
V_{OH}	Output Voltage High, V_+ to V_{OUT}	$R_L = 10k\Omega$		65		mV
				70		mV
V_{OL}	Output Voltage Low, V_{OUT} to V_-	$R_L = 10k\Omega$		38		mV
				45		mV
I_S	Supply Current/Amplifier			0.85		mA
I_{S+}	Source Current Capability			8		mA
I_{S-}	Sink Current Capability			8		mA

ISL70218SRH

Electrical Specifications $V_S \pm 5V$, $V_{CM} = 0$, $V_O = 0V$, $T_A = +25^\circ C$, unless otherwise noted. **Boldface limits apply over the operating temperature range, $-55^\circ C$ to $+125^\circ C$.**

PARAMETER	DESCRIPTION	CONDITIONS	MIN (Note 5)	TYP	MAX (Note 5)	UNIT
AC SPECIFICATIONS						
GBW	Gain Bandwidth Product			3.2		MHz
e_{n-p-p}	Voltage Noise	0.1Hz to 10Hz		320		nV _{P-P}
e_n	Voltage Noise Density	$f = 10\text{Hz}$		9		nV/ $\sqrt{\text{Hz}}$
e_n	Voltage Noise Density	$f = 100\text{Hz}$		5.7		nV/ $\sqrt{\text{Hz}}$
e_n	Voltage Noise Density	$f = 1\text{kHz}$		5.5		nV/ $\sqrt{\text{Hz}}$
e_n	Voltage Noise Density	$f = 10\text{kHz}$		5.5		nV/ $\sqrt{\text{Hz}}$
i_n	Current Noise Density	$f = 1\text{kHz}$		380		fA/ $\sqrt{\text{Hz}}$
THD + N	Total Harmonic Distortion + Noise	1kHz, $G = 1$, $V_O = 1.25V_{RMS}$, $R_L = 10k\Omega$		0.0003		%
TRANSIENT RESPONSE						
SR	Slew Rate	$A_V = 1$, $R_L = 2k\Omega$, $V_O = 4V_{P-P}$		± 1		V/ μs
t_r , t_f , Small Signal	Rise Time 10% to 90% of V_{OUT}	$A_V = 1$, $V_{OUT} = 100mV_{P-P}$, $R_f = 0\Omega$, $R_L = 2k\Omega$ to V_{CM}		100		ns
	Fall Time 90% to 10% of V_{OUT}	$A_V = 1$, $V_{OUT} = 100mV_{P-P}$, $R_f = 0\Omega$, $R_L = 2k\Omega$ to V_{CM}		100		ns
t_s	Settling Time to 0.01% 4V Step; 10% to V_{OUT}	$A_V = 1$, $V_{OUT} = 4V_{P-P}$, $R_f = 0\Omega$, $R_L = 2k\Omega$ to V_{CM}		4		μs

NOTE:

- Compliance to datasheet limits is assured by one or more methods: production test, characterization and/or design.

Post Radiation Characteristics $V_S \pm 15V$, $V_{CM} = 0V$, $V_O = 0V$, $R_L = \text{Open}$, $T_A = +25^\circ C$, unless otherwise noted. **This data is typical test data post radiation exposure at a rate of 50 to 300rad(Si)/s. This data is intended to show typical parameter shifts due to high dose radiation. These are not limits nor are they guaranteed.**

PARAMETER	DESCRIPTION	CONDITIONS	50k RAD	75k RAD	100k RAD	UNIT
V_{OS}	Offset Voltage		35	35	35	μV
I_{OS}	Input Offset Current		2	3	5	nA
I_B	Input Bias Current		200	400	575	nA
CMRR	Common-Mode Rejection Ratio	$V_{CM} = -13V$ to $+13V$	129	128	127	dB
PSRR	Power Supply Rejection Ratio	$V_S = \pm 2.25V$ to $\pm 15V$	130	130	130	dB
A_{VOL}	Open-Loop Gain	$V_O = -13V$ to $+13V$, $R_L = 10k\Omega$ to ground	131.6	131.1	131.1	dB
V_{OH}	Output Voltage High V_+ to V_{OUT}	$R_L = 10k\Omega$ to ground	71	74	76	mV
V_{OL}	Output Voltage Low V_{OUT} to V_-	$R_L = 10k\Omega$ to ground	54	57	59	mV
I_S	Supply Current/Amplifier		830	830	830	μA
TRANSIENT RESPONSE						
SR	Slew Rate	$A_V = 10$, $R_L = 2k\Omega$, $V_O = 4V_{P-P}$	1.24	1.23	1.22	V/ μs

ISL70218SRH

Post Radiation Characteristics $V_S = \pm 15V$, $V_{CM} = 0V$, $V_O = 0V$, $R_L = \text{Open}$, $T_A = +25^\circ\text{C}$, unless otherwise noted. This data is typical test data post radiation exposure at a rate of 10mrad(Si)/s. This data is intended to show typical parameter shifts due to low dose radiation. These are not limits nor are they guaranteed.

PARAMETER	DESCRIPTION	CONDITIONS	20k RAD	50k RAD	100k RAD	UNIT
V_{OS}	Offset Voltage		21	15	10	μV
I_{OS}	Input Offset Current		8	10	10	nA
I_B	Input Bias Current		130	130	130	nA
I_S	Supply Current/Amplifier		625	615	600	μA

Typical Performance Curves $V_S = \pm 15V$, $V_{CM} = 0V$, $R_L = \text{Open}$, unless otherwise specified.

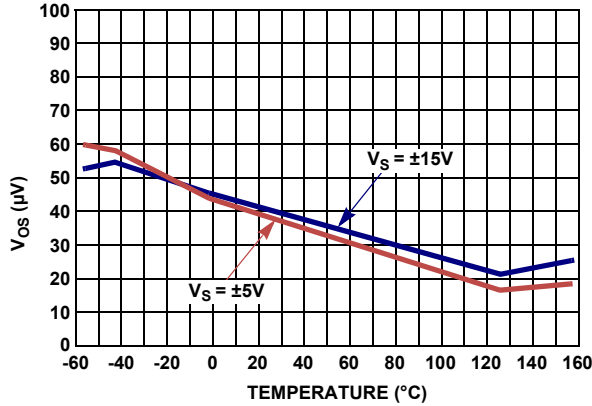

FIGURE 3. V_{OS} vs TEMPERATURE

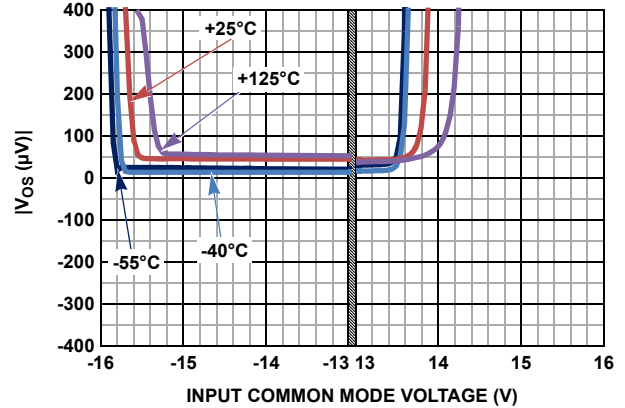

FIGURE 4. INPUT OFFSET VOLTAGE vs INPUT COMMON MODE VOLTAGE, $V_S = \pm 15V$

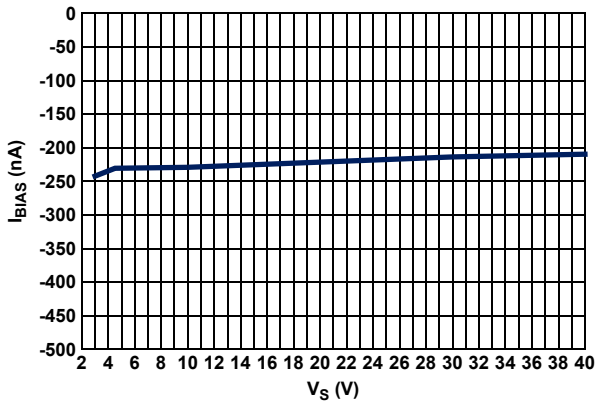

FIGURE 5. I_{BIAS} vs V_S

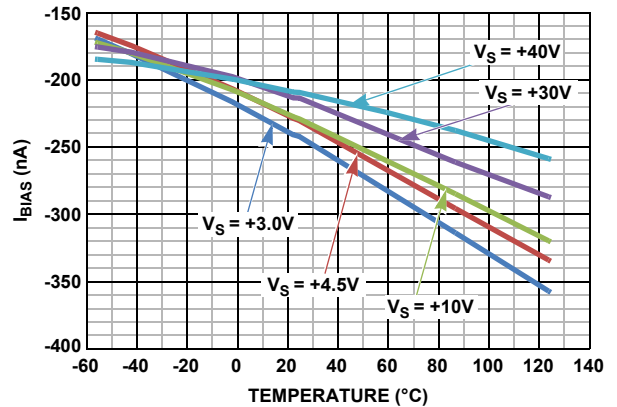

FIGURE 6. I_{BIAS} vs TEMPERATURE vs SUPPLY

Typical Performance Curves $V_S = \pm 15V, V_{CM} = 0V, R_L = \text{Open}$, unless otherwise specified. (Continued)

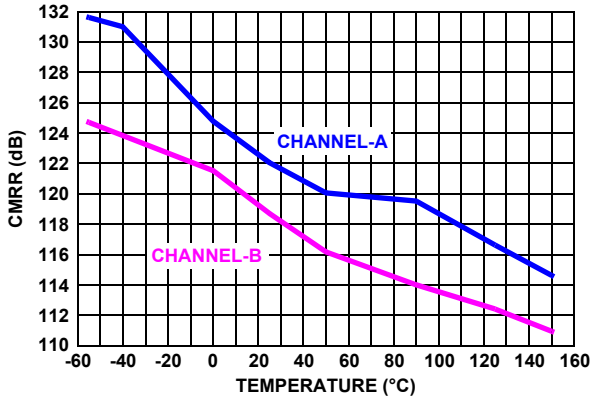

FIGURE 7. CMRR vs TEMPERATURE, $V_S = \pm 15V$

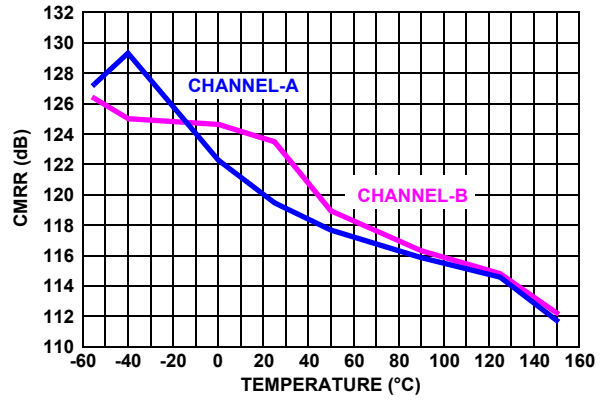

FIGURE 8. CMRR vs TEMPERATURE, $V_S = \pm 5V$

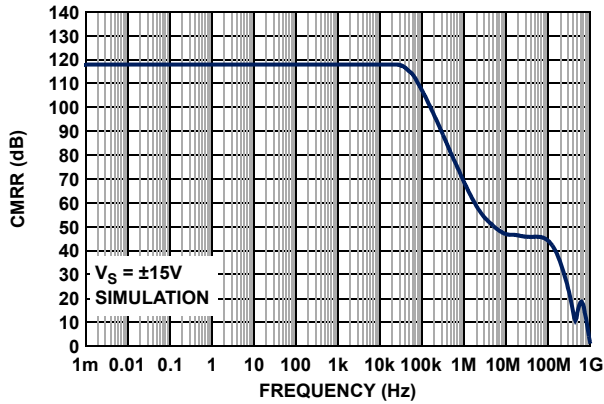

FIGURE 9. CMRR vs FREQUENCY, $V_S = \pm 15V$

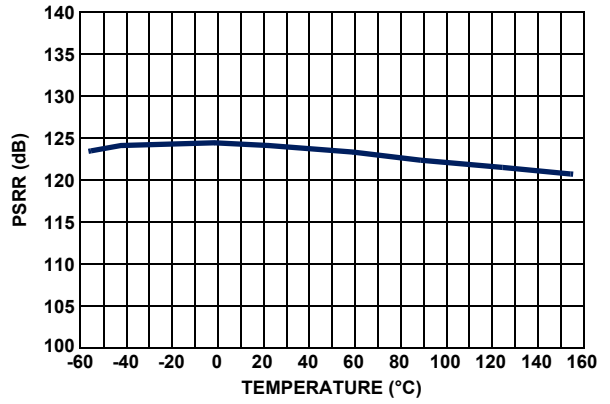

FIGURE 10. PSRR vs TEMPERATURE, $V_S = \pm 15V$

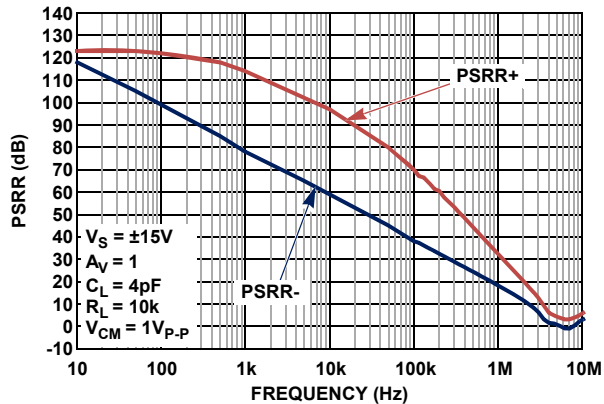

FIGURE 11. PSRR vs FREQUENCY, $V_S = \pm 15V$

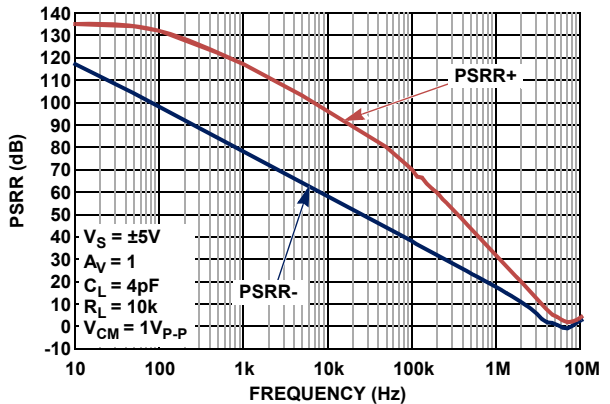

FIGURE 12. PSRR vs FREQUENCY, $V_S = \pm 5V$

Typical Performance Curves $V_S = \pm 15V, V_{CM} = 0V, R_L = \text{Open}$, unless otherwise specified. (Continued)

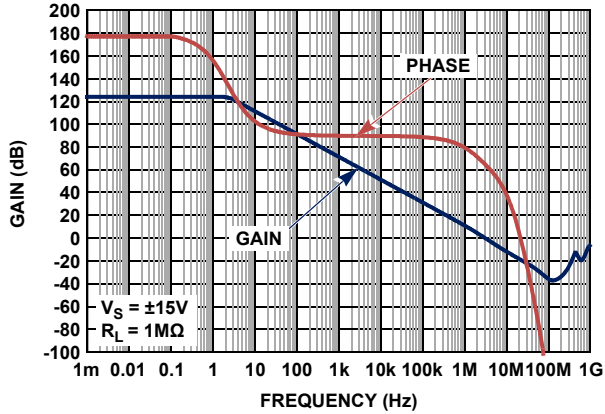

FIGURE 13. OPEN-LOOP GAIN, PHASE vs FREQUENCY, $V_S = \pm 15V$

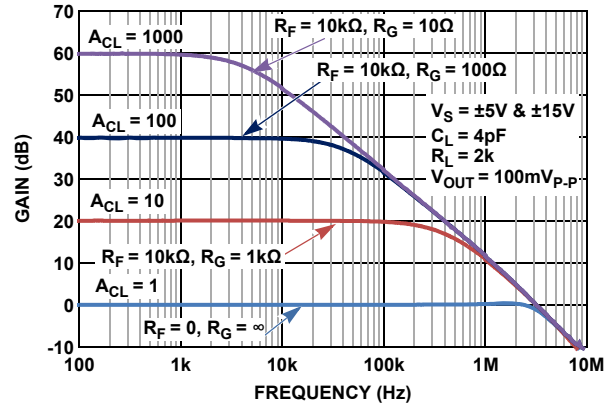

FIGURE 14. FREQUENCY RESPONSE vs CLOSED LOOP GAIN

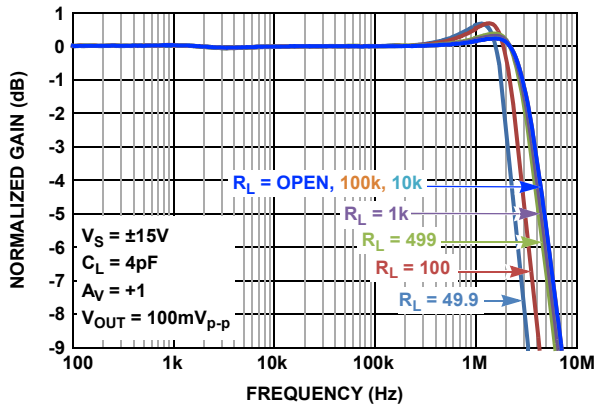

FIGURE 15. GAIN vs FREQUENCY vs $R_L, V_S = \pm 15V$

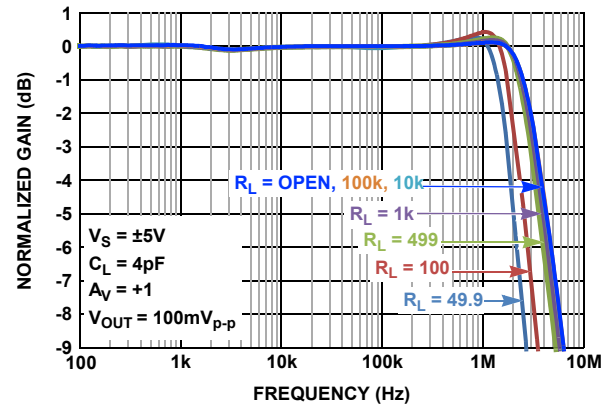

FIGURE 16. GAIN vs FREQUENCY vs $R_L, V_S = \pm 5V$

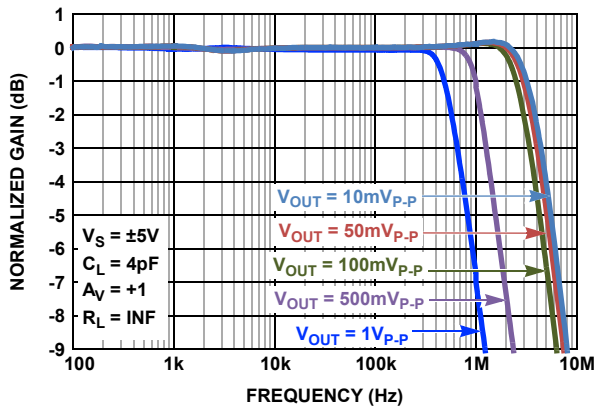

FIGURE 17. GAIN vs FREQUENCY vs OUTPUT VOLTAGE

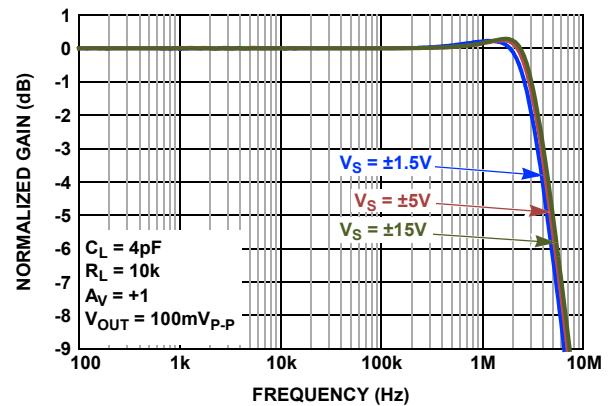

FIGURE 18. GAIN vs FREQUENCY vs SUPPLY VOLTAGE

Typical Performance Curves $V_S = \pm 15V, V_{CM} = 0V, R_L = \text{Open}$, unless otherwise specified. (Continued)

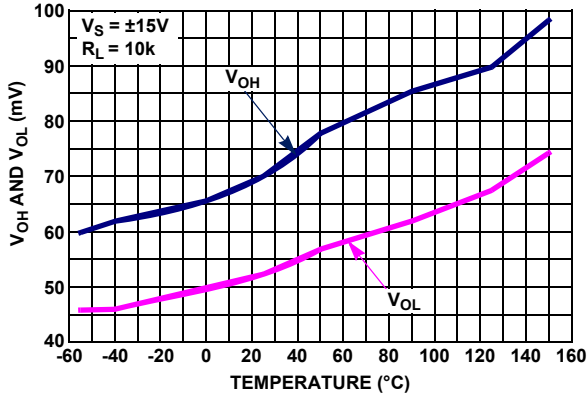

FIGURE 19. OUTPUT OVERHEAD VOLTAGE vs TEMPERATURE, $V_S = \pm 15V, R_L = 10k$

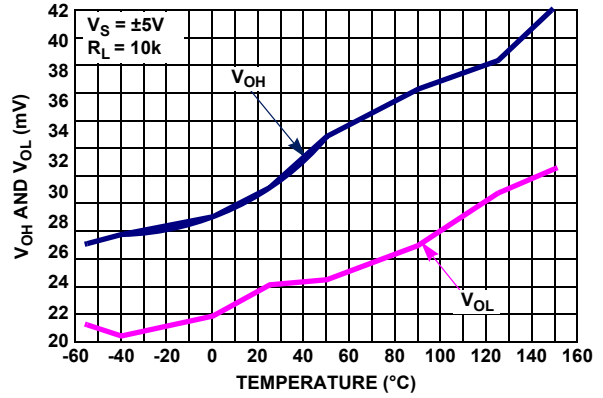

FIGURE 20. OUTPUT OVERHEAD VOLTAGE vs TEMPERATURE, $V_S = \pm 5V, R_L = 10k$

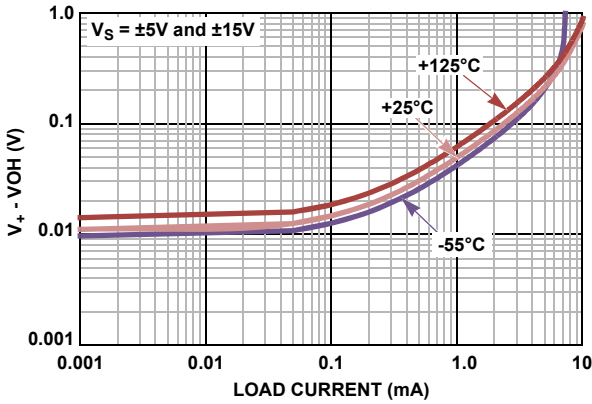

FIGURE 21. OUTPUT OVERHEAD VOLTAGE HIGH vs LOAD CURRENT, $V_S = \pm 5V$ and $\pm 15V$

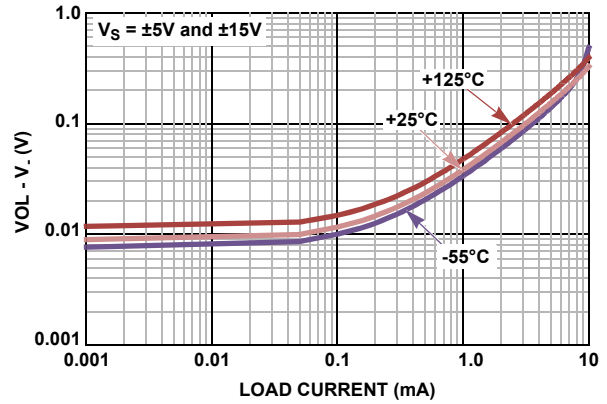

FIGURE 22. OUTPUT OVERHEAD VOLTAGE LOW vs LOAD CURRENT, $V_S = \pm 5V$ and $\pm 15V$

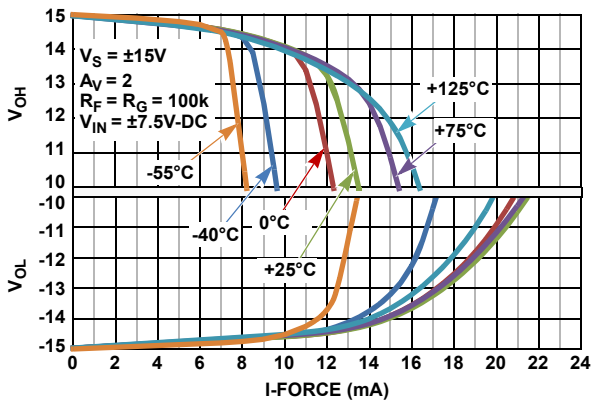

FIGURE 23. OUTPUT VOLTAGE SWING vs LOAD CURRENT, $V_S = \pm 15V$

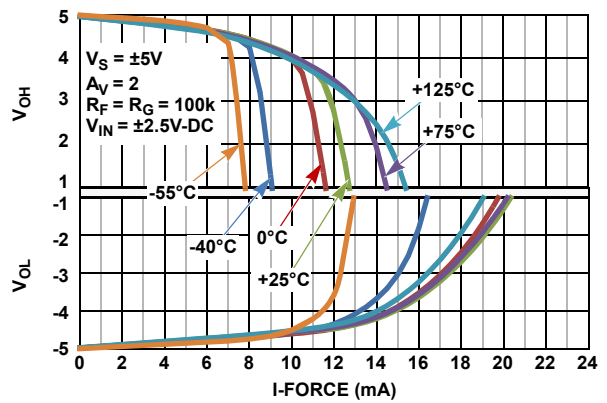

FIGURE 24. OUTPUT VOLTAGE SWING vs LOAD CURRENT, $V_S = \pm 5V$

Typical Performance Curves $V_S = \pm 15V, V_{CM} = 0V, R_L = \text{Open}$, unless otherwise specified. (Continued)

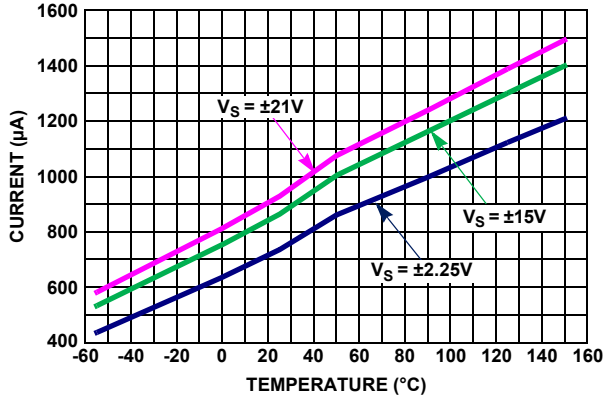

FIGURE 25. SUPPLY CURRENT vs TEMPERATURE vs SUPPLY VOLTAGE

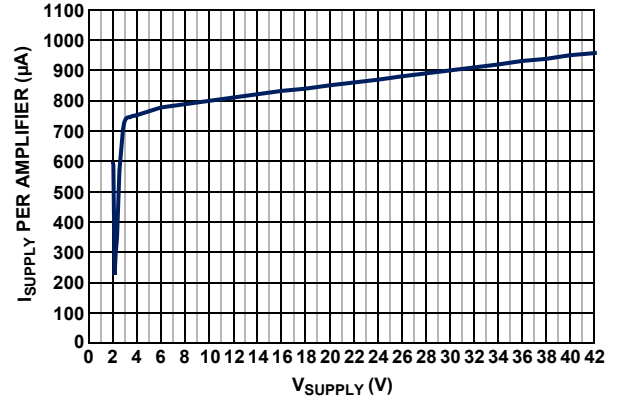

FIGURE 26. SUPPLY CURRENT vs SUPPLY VOLTAGE

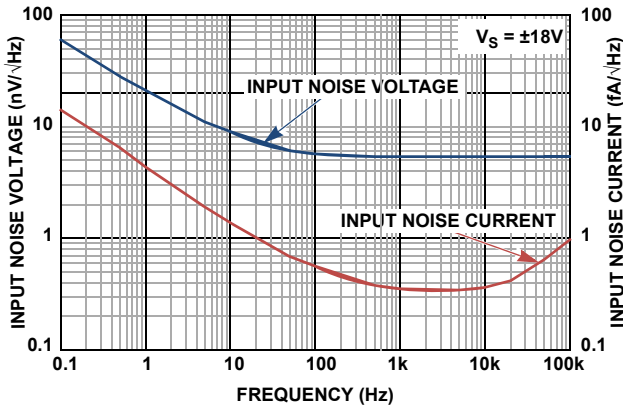

FIGURE 27. INPUT NOISE VOLTAGE (e_n) AND CURRENT (i_n) vs FREQUENCY, $V_S = \pm 18V$

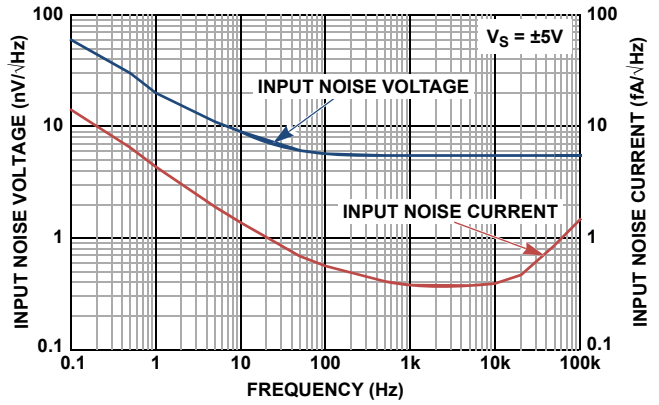

FIGURE 28. INPUT NOISE VOLTAGE (e_n) AND CURRENT (i_n) vs FREQUENCY, $V_S = \pm 5V$

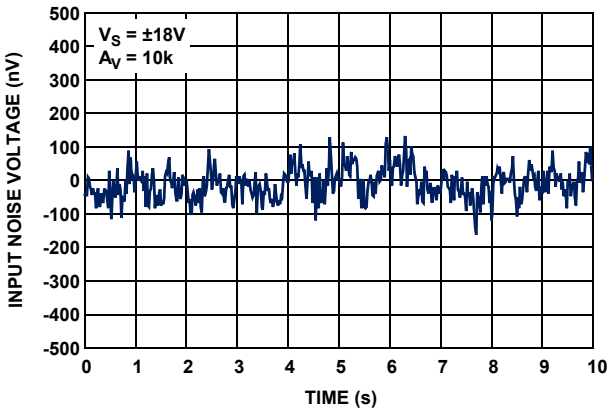

FIGURE 29. INPUT NOISE VOLTAGE 0.1Hz TO 10Hz, $V_S = \pm 18V$

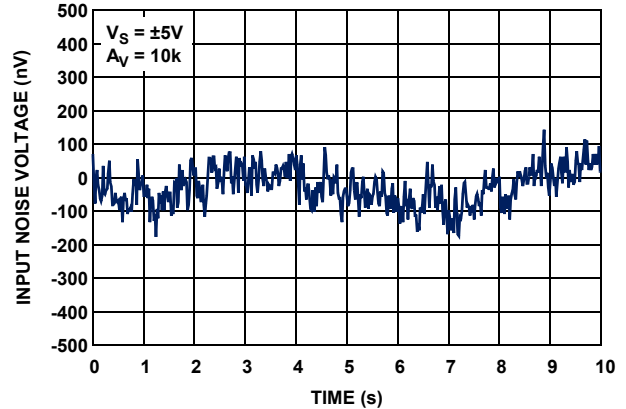

FIGURE 30. INPUT NOISE VOLTAGE 0.1Hz TO 10Hz, $V_S = \pm 5V$

Typical Performance Curves $V_S = \pm 15V, V_{CM} = 0V, R_L = \text{Open}$, unless otherwise specified. (Continued)

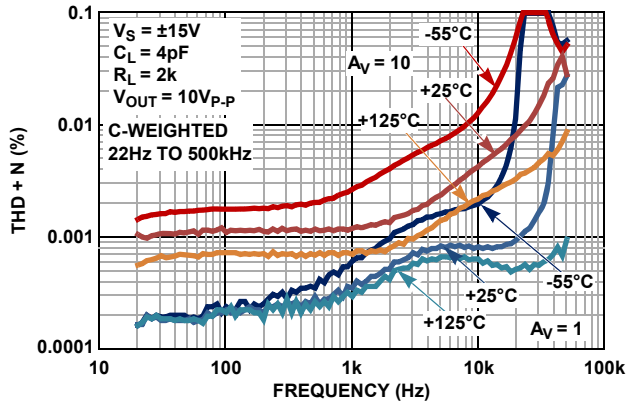

FIGURE 31. THD+N vs FREQUENCY vs TEMPERATURE, $A_V = 1, 10, R_L = 2k$

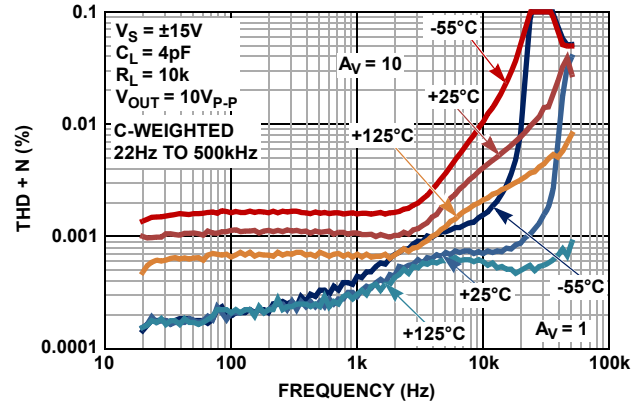

FIGURE 32. THD+N vs FREQUENCY vs TEMPERATURE, $A_V = 1, 10, R_L = 10k$

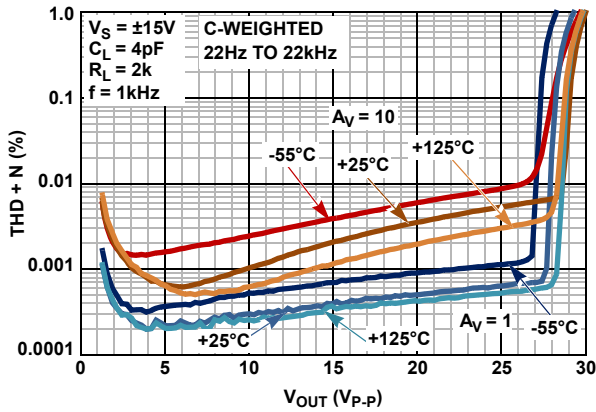

FIGURE 33. THD+N vs OUTPUT VOLTAGE (V_{OUT}) vs TEMPERATURE, $A_V = 1, 10, R_L = 2k$

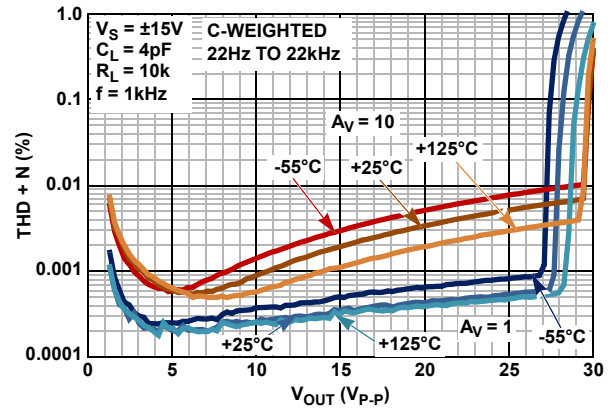

FIGURE 34. THD+N vs OUTPUT VOLTAGE (V_{OUT}) vs TEMPERATURE, $A_V = 1, 10, R_L = 10k$

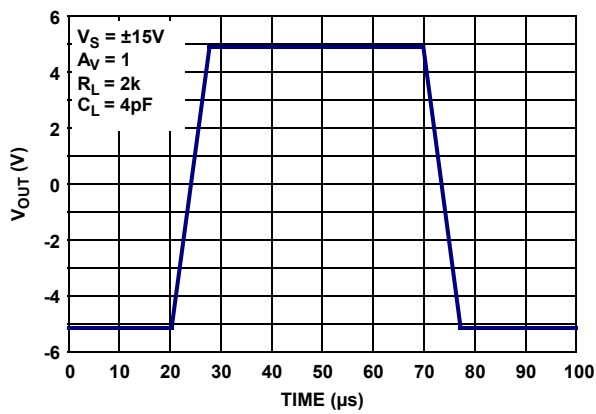

FIGURE 35. LARGE SIGNAL 10V STEP RESPONSE, $V_S = \pm 15V$

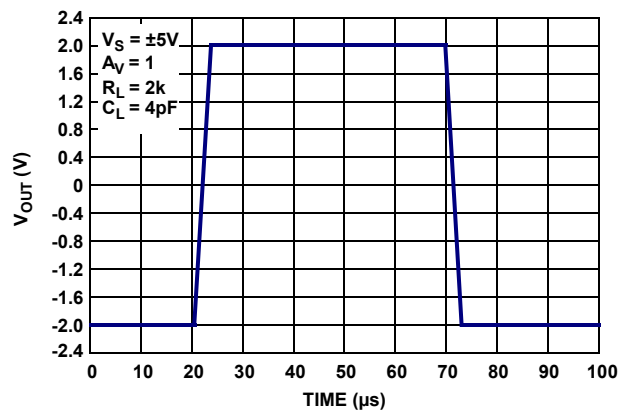

FIGURE 36. LARGE SIGNAL 4V STEP RESPONSE, $V_S = \pm 5V$

Typical Performance Curves $V_S = \pm 15V, V_{CM} = 0V, R_L = \text{Open}$, unless otherwise specified. (Continued)

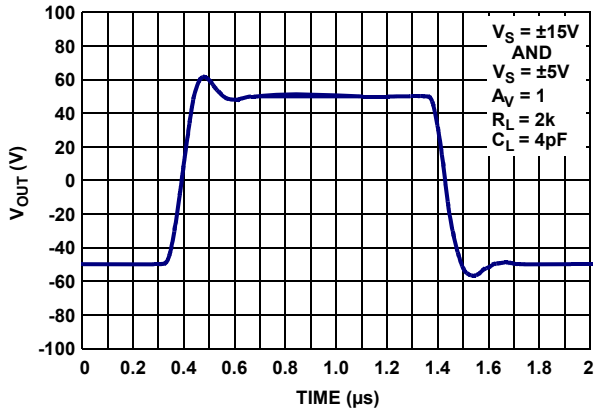

FIGURE 37. SMALL SIGNAL TRANSIENT RESPONSE, $V_S = \pm 5V, \pm 15V$

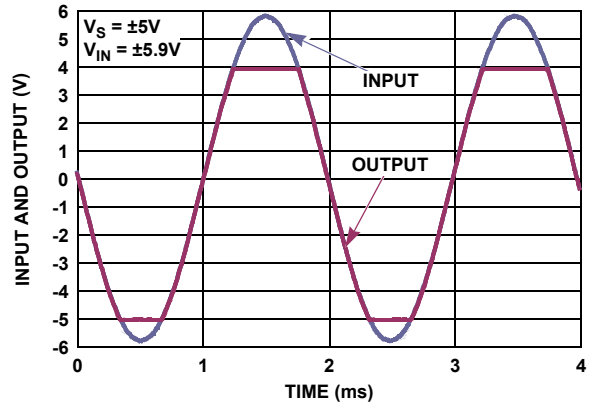

FIGURE 38. NO PHASE REVERSAL

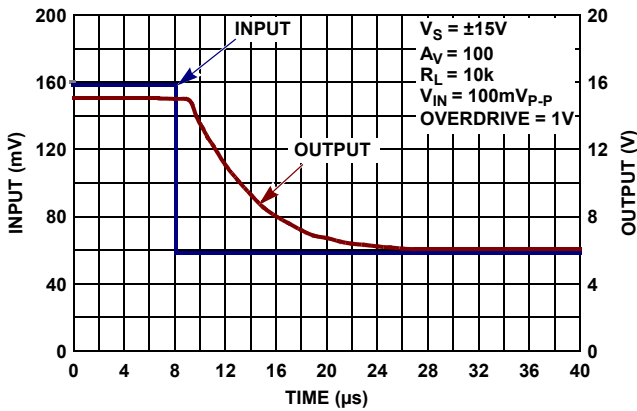

FIGURE 39. POSITIVE OUTPUT OVERLOAD RESPONSE TIME, $V_S = \pm 15V$

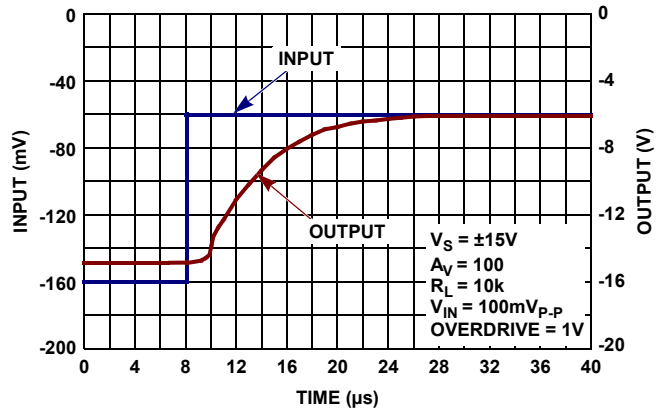

FIGURE 40. NEGATIVE OUTPUT OVERLOAD RESPONSE TIME, $V_S = \pm 15V$

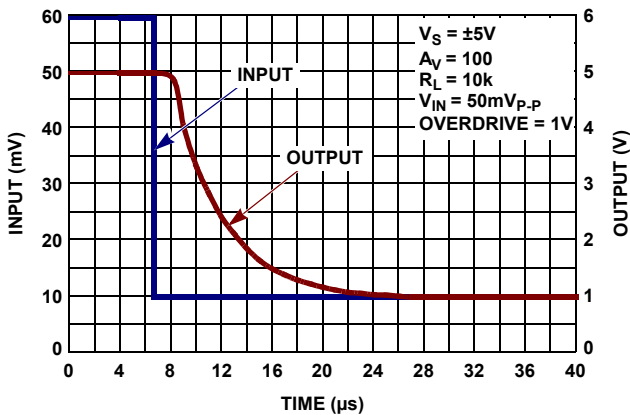

FIGURE 41. POSITIVE OUTPUT OVERLOAD RESPONSE TIME, $V_S = \pm 5V$

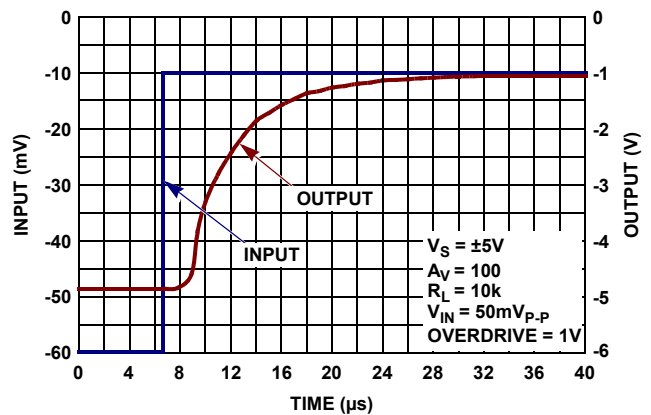

FIGURE 42. NEGATIVE OUTPUT OVERLOAD RESPONSE TIME, $V_S = \pm 5V$

Typical Performance Curves $V_S = \pm 15V, V_{CM} = 0V, R_L = \text{Open}$, unless otherwise specified. (Continued)

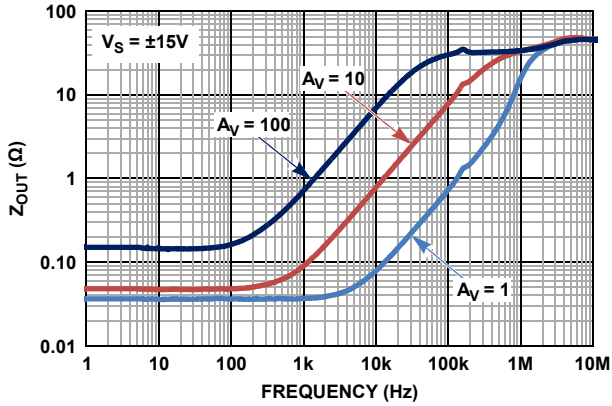

FIGURE 43. OUTPUT IMPEDANCE vs FREQUENCY, $V_S = \pm 15V$

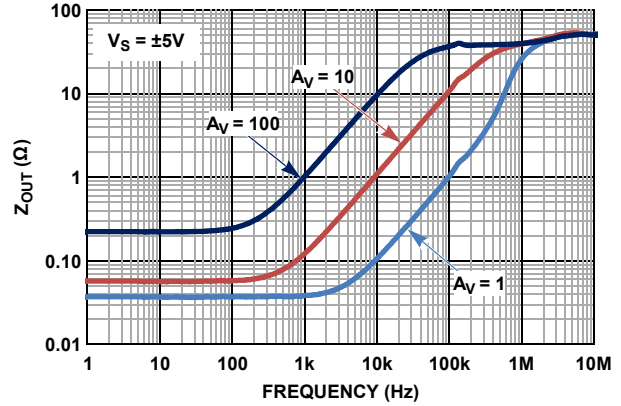

FIGURE 44. OUTPUT IMPEDANCE vs FREQUENCY, $V_S = \pm 5V$

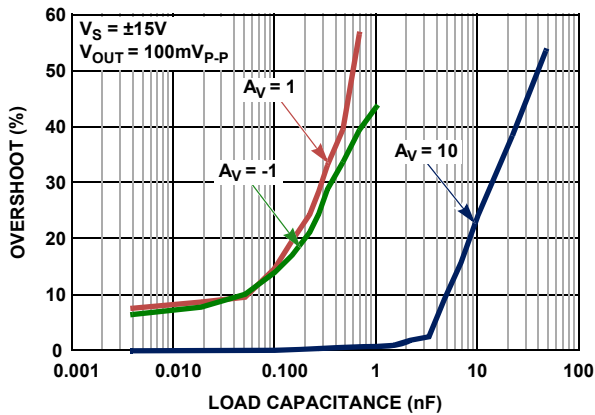

FIGURE 45. OVERSHOOT vs CAPACITIVE LOAD, $V_S = \pm 15V$

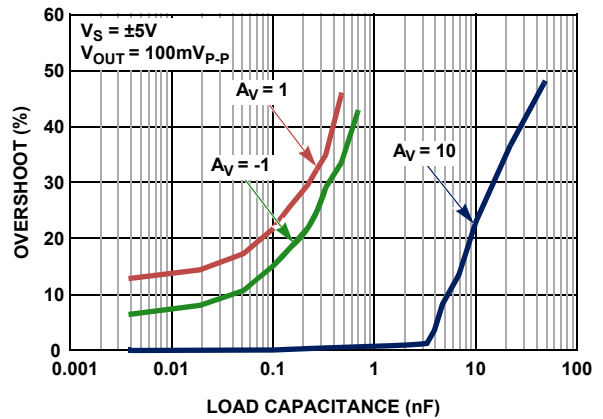

FIGURE 46. OVERSHOOT vs CAPACITIVE LOAD, $V_S = \pm 5V$

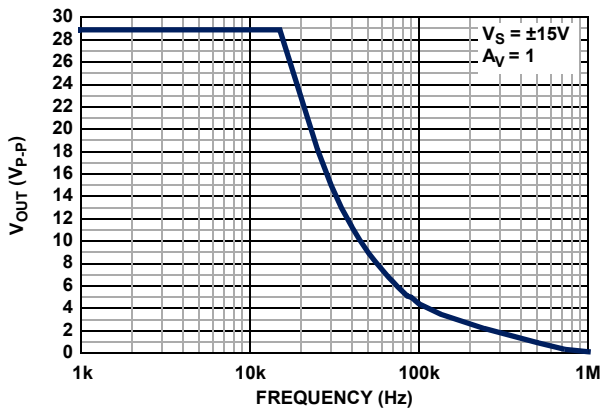

FIGURE 47. I_MAX OUTPUT VOLTAGE vs FREQUENCY

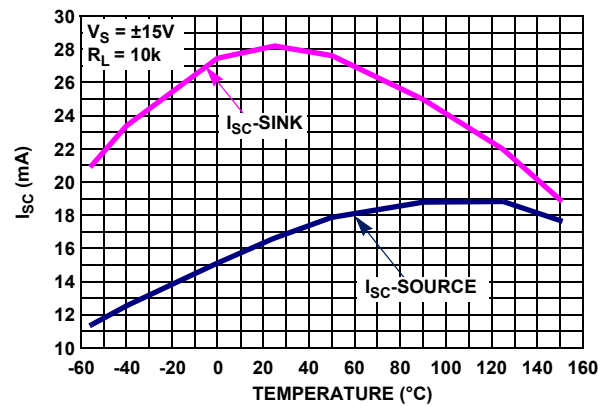

FIGURE 48. SHORT CIRCUIT CURRENT vs TEMPERATURE, $V_S = \pm 15V$

Applications Information

Functional Description

The ISL70218SRH is a dual, 3.2MHz, single-supply, rail-to-rail output amplifier with a common mode input voltage range extending to a range of 0.5V below the V- rail. The input stage is optimized for precision sensing of ground-referenced signals in single-supply applications. The input stage is able to handle large input differential voltages without phase inversion, making this amplifier suitable for high-voltage comparator applications. The bipolar design features high open loop gain and excellent DC input and output temperature stability. This op amp features very low quiescent current of 850µA, and low temperature drift. The device is fabricated in a new precision 40V complementary bipolar DI process and is immune from latch-up for up to a 36V supply range.

Operating Voltage Range

The op amp is designed to operate over a single supply range of 3V to 36V or a split supply voltage range of +1.8V/-1.2V to ±18V. The device is fully characterized at 30V (±15V). Both DC and AC performance remain virtually unchanged over the complete operating voltage range. Parameter variation with operating voltage is shown in the “Typical Performance Curves” beginning on page 6.

The input common mode voltage to the V+ rail (V+ - 1.8V over the full temperature range) may limit amplifier operation when operating from split V+ and V- supplies. Figure 4 shows the common mode input voltage range variation over temperature.

Input Stage Performance

The ISL70218SRH PNP input stage has a common mode input range extending up to 0.5V below ground at +25°C. Full amplifier performance is guaranteed for input voltage down to ground (V-) over the -55°C to +125°C temperature range. For common mode voltages down to -0.5V below ground (V-), the amplifiers are fully functional, but performance degrades slightly over the full temperature range. This feature provides excellent CMRR, AC performance, and DC accuracy when amplifying low-level, ground-referenced signals.

The input stage has a maximum input differential voltage equal to a diode drop greater than the supply voltage and does not contain the back-to-back input protection diodes found on many similar amplifiers. This feature enables the device to function as a precision comparator by maintaining very high input impedance for high-voltage differential input comparator voltages. The high differential input impedance also enables the device to operate reliably in large signal pulse applications, without the need for anti-parallel clamp diodes required on MOSFET and most bipolar input stage op amps. Thus, input signal distortion caused by nonlinear clamps under high slew rate conditions is avoided.

In applications in which one or both amplifier input terminals is at risk of exposure to voltages beyond the supply rails, current-limiting resistors may be needed at each input terminal (see Figure 49, R_{IN+} , R_{IN-}) to limit current through the power-supply ESD diodes to 20mA.

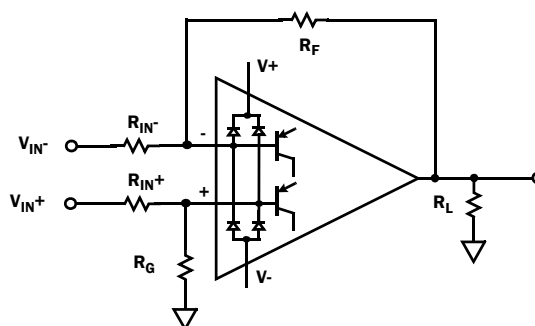

FIGURE 49. INPUT ESD DIODE CURRENT LIMITING

Output Drive Capability

The bipolar rail-to-rail output stage features low saturation levels that enable an output voltage swing to less than 15mV when the total output load (including feedback resistance) is held below 50µA (Figures 21 and 22). With ±15V supplies, this can be achieved by using feedback resistor values >300kΩ.

The output stage is internally current limited. Output current limit over temperature is shown in Figures 23 and 24. The amplifiers can withstand a short circuit to either rail as long as the power dissipation limits are not exceeded. This applies to only one amplifier at a time for the dual op amp. Continuous operation under these conditions may degrade long-term reliability.

The amplifiers perform well when driving capacitive loads (Figures 45 and 46). The unity gain, voltage follower (buffer) configuration provides the highest bandwidth but is also the most sensitive to ringing produced by load capacitance found in BNC cables. Unity gain overshoot is limited to 35% at capacitance values to 0.33nF. At gains of 10 and higher, the device is capable of driving more than 10nF without significant overshoot.

Output Phase Reversal

Output phase reversal is a change of polarity in the amplifier transfer function when the input voltage exceeds the supply voltage. The ISL70218SRH is immune to output phase reversal out to 0.5V beyond the rail ($V_{ABS\ MAX}$) limit (Figure 38).

Single Channel Usage

The ISL70218SRH is a dual op amp. If the application requires only one channel, the user must configure the unused channel to prevent it from oscillating. The unused channel oscillates if the input and output pins are floating. This results in higher-than-expected supply currents and possible noise injection into the channel being used. The proper way to prevent oscillation is to short the output to the inverting input, and ground the positive input (Figure 50).

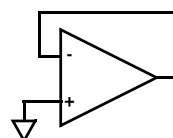

FIGURE 50. PREVENTING OSCILLATIONS IN UNUSED CHANNELS

Power Dissipation

It is possible to exceed the +150°C maximum junction temperatures under certain load and power supply conditions. It is therefore important to calculate the maximum junction temperature (T_{JMAX}) for all applications to determine if power supply voltages, load conditions, or package type need to be modified to remain in the safe operating area. These parameters are related using Equation 1:

$$T_{JMAX} = T_{MAX} + \theta_{JA} \times PD_{MAXTOTAL} \quad (EQ. 1)$$

where

- $PD_{MAXTOTAL}$ is the sum of the maximum power dissipation of each amplifier in the package (PD_{MAX})
- T_{MAX} = Maximum ambient temperature
- θ_{JA} = Thermal resistance of the package

PD_{MAX} for each amplifier can be calculated using Equation 2:

$$PD_{MAX} = V_S \times I_{qMAX} + (V_S - V_{OUTMAX}) \times \frac{V_{OUTMAX}}{R_L} \quad (EQ. 2)$$

where

- PD_{MAX} = Maximum power dissipation of one amplifier
- V_S = Total supply voltage
- I_{qMAX} = Maximum quiescent supply current of one amplifier
- V_{OUTMAX} = Maximum output voltage swing of the application
- R_L = Load resistance

ISL70218SRH

Package Characteristics

Weight of Packaged Device

0.4029 grams (Typical)

Lid Characteristics

Finish: Gold

Potential: Floating

Die Characteristics

Die Dimensions

1565 μ m x 2125 μ m (62mils x 84mils)

Thickness: 355 μ m \pm 25 μ m (14 mils \pm 1 mil)

Interface Materials

GLASSIVATION

Type: Nitrox

Thickness: 15k Å

Metallization Mask Layout

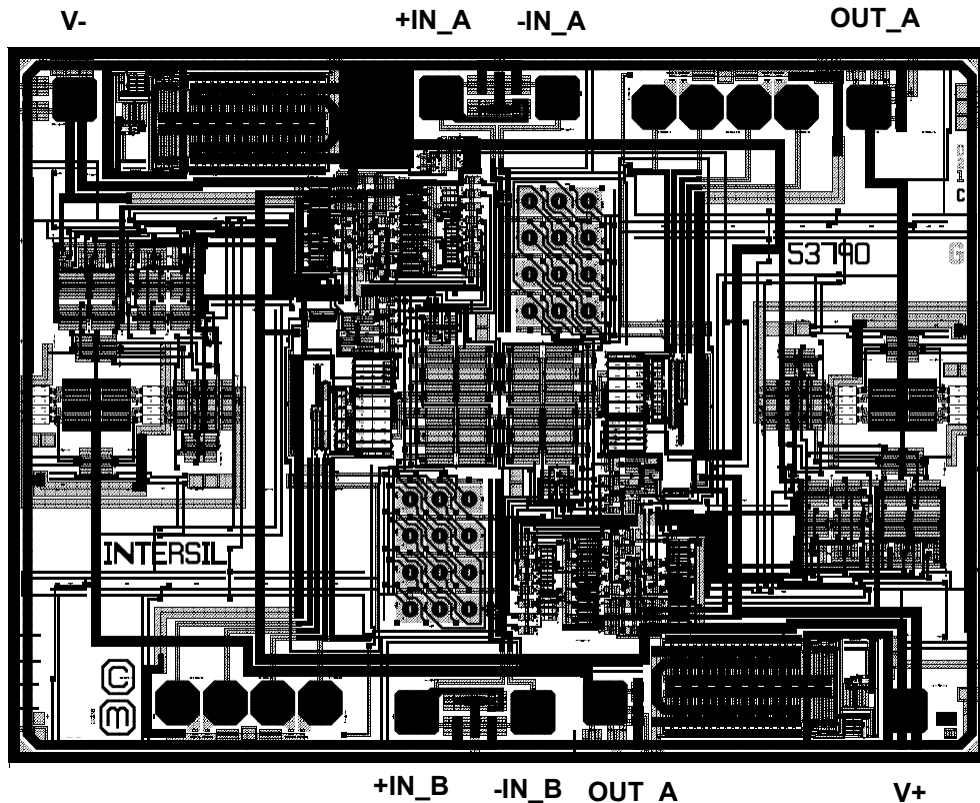

TOP METALLIZATION

Type: AlCu (99.5%/0.5%)

Thickness: 30k Å

BACKSIDE FINISH

Silicon

PROCESS

PR40

ASSEMBLY RELATED INFORMATION

SUBSTRATE POTENTIAL

Unbiased

ADDITIONAL INFORMATION

WORST CASE CURRENT DENSITY

$< 2 \times 10^5$ A/cm 2

ISL70218SRH

Revision History

The revision history provided is for informational purposes only and is believed to be accurate, but not warranted. Please go to web to make sure you have the latest revision.

DATE	REVISION	CHANGE
8/17/11	FN7871.1	Removed coming soon from parts ISL70218SRHMF AND ISL70218SRHMX AND ISL70218SRHX/SAMPLE in Ordering Information Table.
8/9/2011	FN7871.0	Initial Release

Products

Intersil Corporation is a leader in the design and manufacture of high-performance analog semiconductors. The Company's products address some of the industry's fastest growing markets, such as, flat panel displays, cell phones, handheld products, and notebooks. Intersil's product families address power management and analog signal processing functions. Go to www.intersil.com/products for a complete list of Intersil product families.

For a complete listing of Applications, Related Documentation and Related Parts, please see the respective device information page on intersil.com: [ISL70218SRH](http://www.intersil.com/ISL70218SRH)

To report errors or suggestions for this datasheet, please go to: www.intersil.com/askourstaff

FITs are available from our website at: <http://rel.intersil.com/reports/search.php>

For additional products, see www.intersil.com/product_tree

Intersil products are manufactured, assembled and tested utilizing ISO9000 quality systems as noted in the quality certifications found at www.intersil.com/design/quality

Intersil products are sold by description only. Intersil Corporation reserves the right to make changes in circuit design, software and/or specifications at any time without notice. Accordingly, the reader is cautioned to verify that data sheets are current before placing orders. Information furnished by Intersil is believed to be accurate and reliable. However, no responsibility is assumed by Intersil or its subsidiaries for its use; nor for any infringements of patents or other rights of third parties which may result from its use. No license is granted by implication or otherwise under any patent or patent rights of Intersil or its subsidiaries.

For information regarding Intersil Corporation and its products, see www.intersil.com

ISL70218SRH

Ceramic Metal Seal Flatpack Packages (Flatpack)

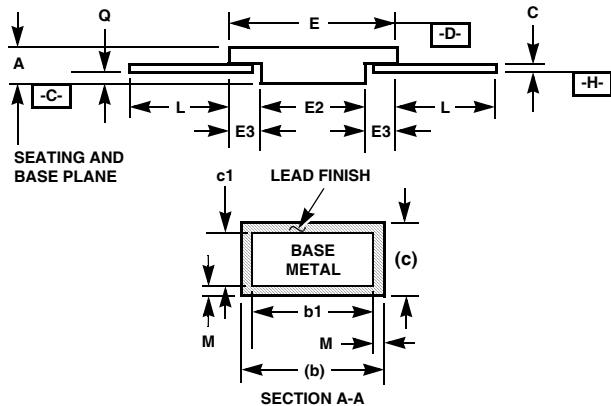
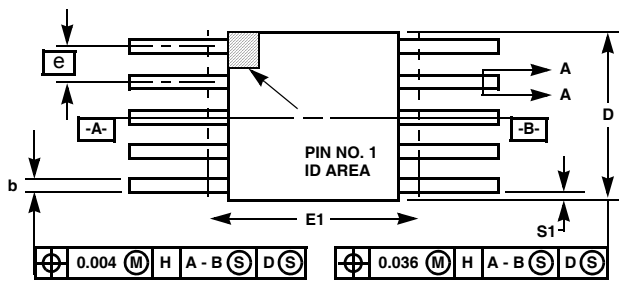

K10.A MIL-STD-1835 CDFP3-F10 (F-4A, CONFIGURATION B) 10 LEAD CERAMIC METAL SEAL FLATPACK PACKAGE

SYMBOL	INCHES		MILLIMETERS		NOTES
	MIN	MAX	MIN	MAX	
A	0.045	0.115	1.14	2.92	-
b	0.015	0.022	0.38	0.56	-
b1	0.015	0.019	0.38	0.48	-
c	0.004	0.009	0.10	0.23	-
c1	0.004	0.006	0.10	0.15	-
D	-	0.290	-	7.37	3
E	0.240	0.260	6.10	6.60	-
E1	-	0.280	-	7.11	3
E2	0.125	-	3.18	-	-
E3	0.030	-	0.76	-	7
e	0.050 BSC		1.27 BSC		-
k	0.008	0.015	0.20	0.38	2
L	0.250	0.370	6.35	9.40	-
Q	0.026	0.045	0.66	1.14	8
S1	0.005	-	0.13	-	6
M	-	0.0015	-	0.04	-
N	10		10		-

Rev. 0 3/07

NOTES:

1. Index area: A notch or a pin one identification mark shall be located adjacent to pin one and shall be located within the shaded area shown. The manufacturer's identification shall not be used as a pin one identification mark. Alternately, a tab (dimension k) may be used to identify pin one.
2. If a pin one identification mark is used in addition to a tab, the limits of dimension k do not apply.
3. This dimension allows for off-center lid, meniscus, and glass overrun.
4. Dimensions b1 and c1 apply to lead base metal only. Dimension M applies to lead plating and finish thickness. The maximum limits of lead dimensions b and c or M shall be measured at the centroid of the finished lead surfaces, when solder dip or tin plate lead finish is applied.
5. N is the maximum number of terminal positions.
6. Measure dimension S1 at all four corners.
7. For bottom-brazed lead packages, no organic or polymeric materials shall be molded to the bottom of the package to cover the leads.
8. Dimension Q shall be measured at the point of exit (beyond the meniscus) of the lead from the body. Dimension Q minimum shall be reduced by 0.0015 inch (0.038mm) maximum when solder dip lead finish is applied.
9. Dimensioning and tolerancing per ANSI Y14.5M - 1982.
10. Controlling dimension: INCH.