



DESCRIPTION

The AD6C212 is a bi-directional, single-pole, single-throw, normally closed multipurpose solid-state relay. It is designed to replace electromechanical relays in general purpose switching applications. The relay consists of an integrated circuit that drives two rugged source-to-source depletion type DMOS transistors - optically coupled to a light emitting diode. The output MOS transistors are protected with free-wheeling diodes that can handle up to 1.5A of inrush current, making the relay ideal for switching lamps and highly inductive loads.

FEATURES

- High input-to-output isolation
- Low input control power consumption
- 140mA maximum continuous load current
- 25 ohms maximum on-resistance
- Long life/high reliability

APPLICATIONS

- Telecom switching
- Tip/Ring control
- PCMCIA modules
- Multiplexers
- Meter reading systems
- Data acquisition
- Medical equipment
- Battery monitoring
- Home/Safety security systems

OPTIONS/SUFFIXES

- -H High Output Isolation
- -S Surface Mount Option
- -TR Tape and Reel

MAXIMUM RATINGS

PARAMETER	UNIT	MIN	TYP	MAX
Storage Temperature	°C	-55		125
Operating Temperature	°C	-40		85
Continuous Input Current	mA			40
Transient Input Current	mA			400
Reverse Input Control Voltage	V	6		
Output Power Dissipation	mW			500

SCHEMATIC DIAGRAM

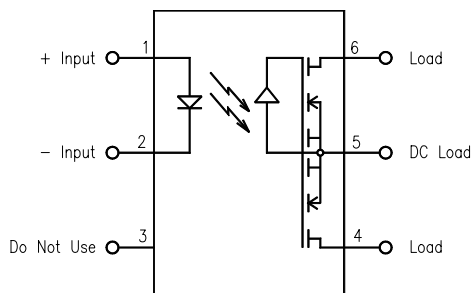

APPROVALS

- BAPT CERTIFICATE #607836:
BS EN 60950, BS EN 41003, BS EN 60065
- CSA CERTIFICATE #LR111581-1
- UL FILE #E90096

ELECTRICAL CHARACTERISTICS - 25°

PARAMETER	UNIT	MIN	TYP	MAX	TEST CONDITIONS
INPUT SPECIFICATIONS					
LED Forward Voltage	V		1.2	1.5	If = 10mA
LED Reverse Voltage	V	6	12		Ir = 10uA
Turn-On Current	m A		0.5		Io = 140mA
Turn-Off Current	m A		2.5	5	
OUTPUT SPECIFICATIONS					
Blocking Voltage	V	400			Io = 10uA
Continuous Load Current	m A			140	If = 0mA
On-Resistance	Ω		20	25	Io = 140mA
Leakage Current	μ A		0.2	10	Vo = 400V
Output Capacitance	p F		25	50	Vo = 25V, f = 1.0MHz
Offset Voltage	m V			0.2	If = 0mA
COUPLED SPECIFICATIONS					
Isolation Voltage	V	2500			T = 1 minute
-H Suffix	V	3750			T = 1 minute
Turn-On Time	m s		0.1	0.5	If = 0mA, Io = 140mA
Turn-Off Time	m s		0.5	1	If = 5mA, Io = 140mA
Isolation Resistance	G Ω	100			
Coupled Capacitance	p F		3		
Contact Transient Ratio	V / μ s	2000	7000		dV = 50V



PERFORMANCE DATA

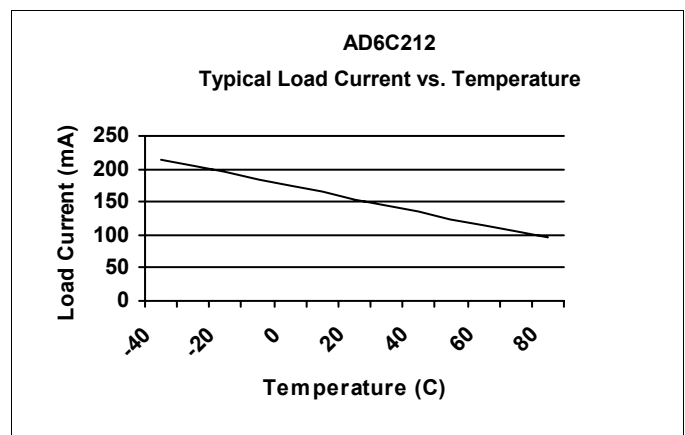
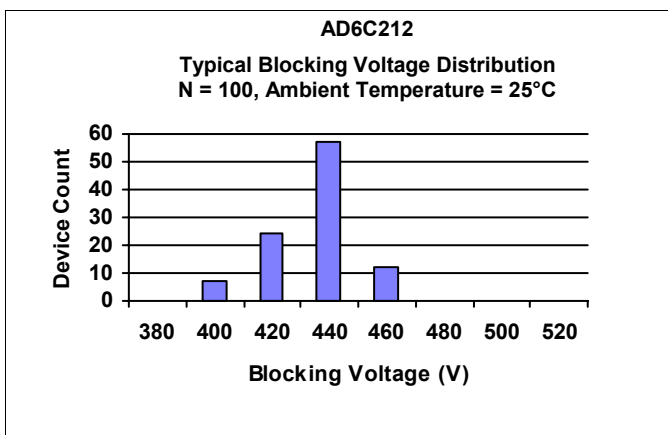
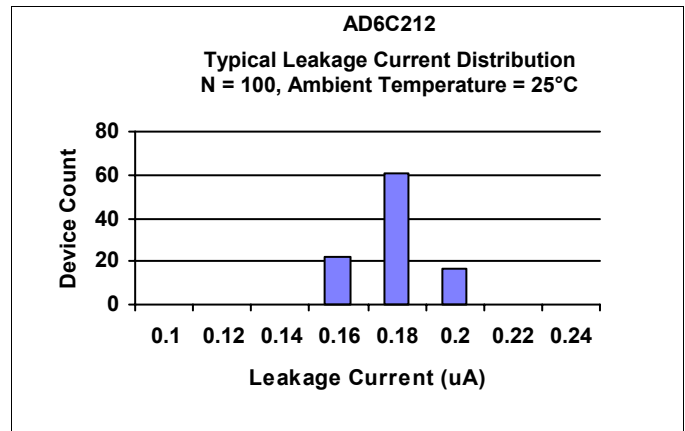
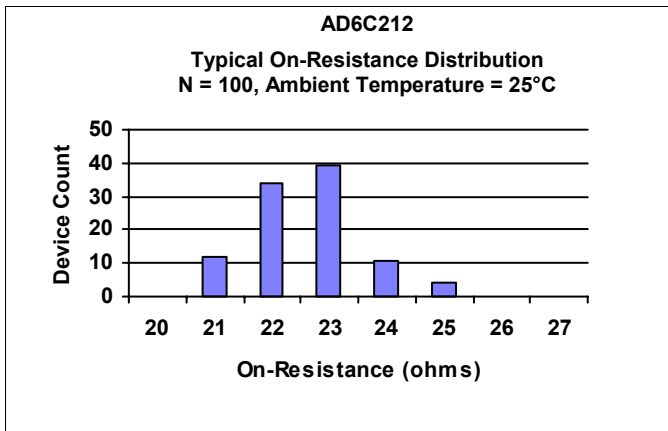
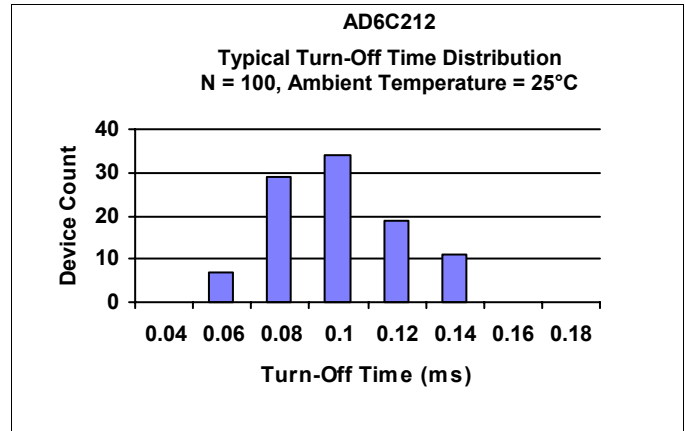
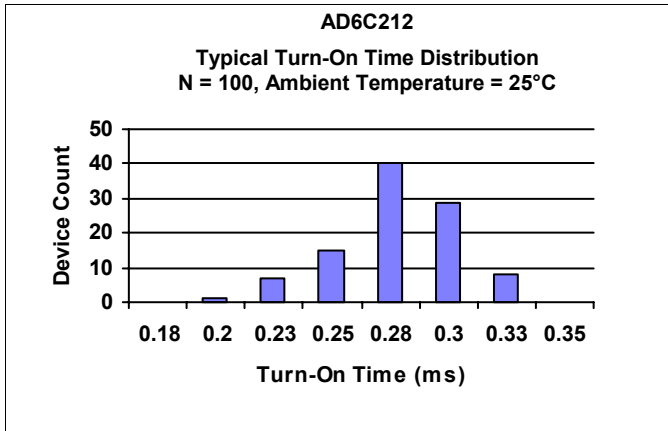



MECHANICAL DIMENSIONS

6 PIN DUAL IN-LINE PACKAGE

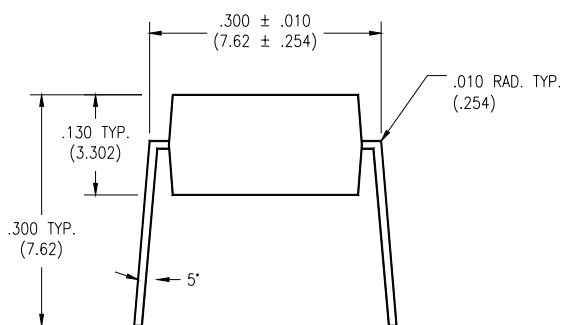

END VIEW

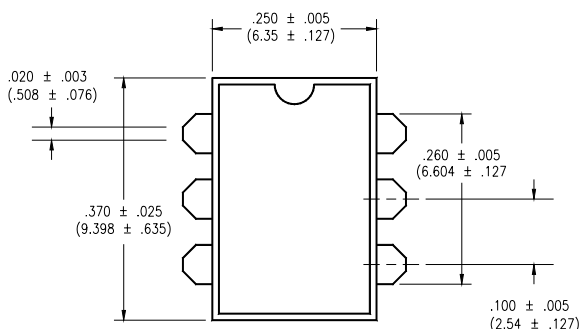

TOP VIEW

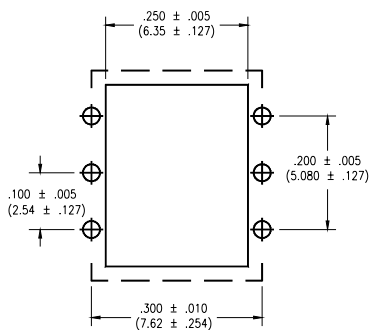

**BOTTOM VIEW/
BOARD PATTERN**

6 PIN SURFACE MOUNT DEVICE

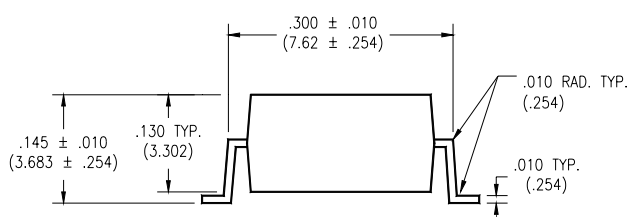

END VIEW

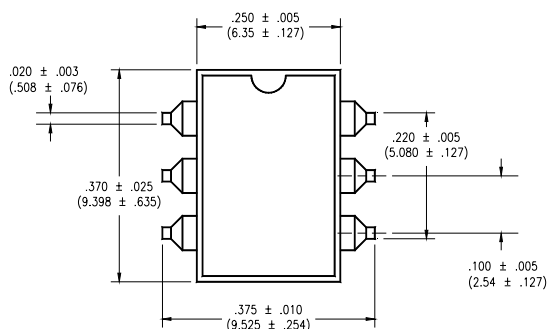

TOP VIEW

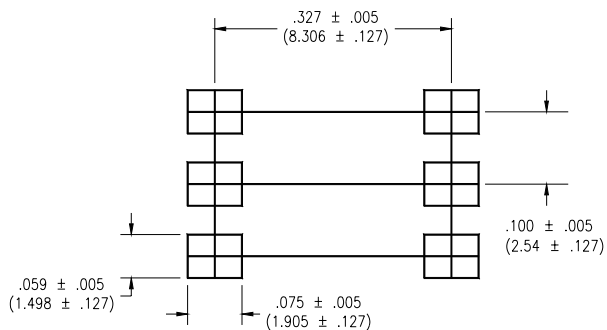

**BOTTOM VIEW/
BOARD PATTERN**