



DESCRIPTION

The AD6C332 is a bi-directional, single-pole, single-throw, normally closed multipurpose solid-state relay. It is designed to replace electromechanical relays in general purpose switching applications. The relay consists of an integrated circuit that drives two rugged source-to-source depletion type DMOS transistors - optically coupled to a light emitting diode. The output MOS transistors are protected with free-wheeling diodes that can handle up to 5A of inrush current, making the relay ideal for switching lamps and highly inductive loads.

FEATURES

- Low On-resistance (10 Ohms MAX)
- Low input control power consumption (2.5mA TYP)
- 200mA maximum continuous load current
- High input-to-output isolation
- Long life/high reliability

OPTIONS/SUFFIXES*

- -S Surface Mount Leadform Option
- -TR Tape and Reel Option

NOTE: Suffixes listed above are not included in marking on device for part number identification.

SCHEMATIC DIAGRAM

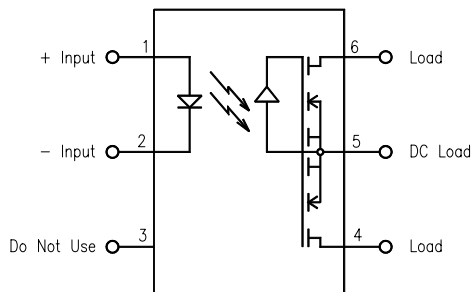

APPLICATIONS

- Reed relay replacement
- Meter reading systems
- Medical equipment
- Battery monitoring
- Multiplexers

ABSOLUTE MAXIMUM RATINGS*

PARAMETER	UNIT	MIN	TYP	MAX
Storage Temperature	°C	-55		125
Operating Temperature	°C	-40		85
Continuous Input Current	mA			40
Transient Input Current	mA			400
Reverse Input Control Voltage	V	6		
Output Power Dissipation	mW			800

*The values indicated are absolute stress ratings. Functional operation of the device is not implied at these or any conditions in excess of those defined in electrical characteristics section of this document. Exposure to Absolute Ratings may cause permanent damage to the device and may adversely affect reliability.

APPROVALS

- BAPT CERTIFICATE #607836
BS EN 60950, BS EN 41003, BS EN 60065
- CSA CERTIFICATE #LR111581-1

ELECTRICAL CHARACTERISTICS - 25°C

PARAMETER	UNIT	MIN	TYP	MAX	TEST CONDITIONS
INPUT SPECIFICATIONS					
LED Forward Voltage	V		1.2	1.5	If = 5mA
LED Reverse Voltage	V	6	12		Ir = 10uA
Turn-On Current	m A		0.5		Io = 200mA
Turn-Off Current	m A		2.5	5	
OUTPUT SPECIFICATIONS					
Blocking Voltage	V	250			Io = 1uA
Continuous Load Current	m A			200	If = 0mA
On-Resistance	Ω		8	10	Io = 200mA
Leakage Current	μ A		0.2	1	Vo = 250V
Output Capacitance	p F			25	Vo = 25V, f = 1.0MHz
Offset Voltage	m V			0.2	If = 0mA
COUPLED SPECIFICATIONS					
Isolation Voltage	V	2500			T = 1 minute
-H Suffix	V	3750			T = 1 minute
Turn-On Time	m s		0.8	2	If = 0mA, Io = 200mA
Turn-Off Time	m s		1	5	If = 5mA, Io = 200mA
Isolation Resistance	G Ω	100			
Coupled Capacitance	p F		3		
Contact Transient Ratio	V / μ s	2000	7000		dV = 50V

PERFORMANCE DATA

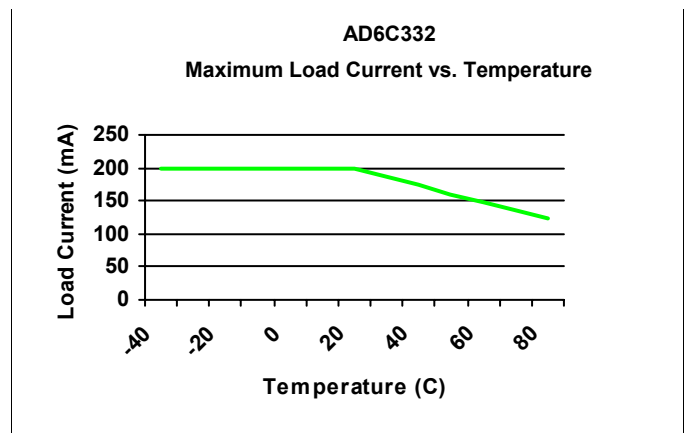
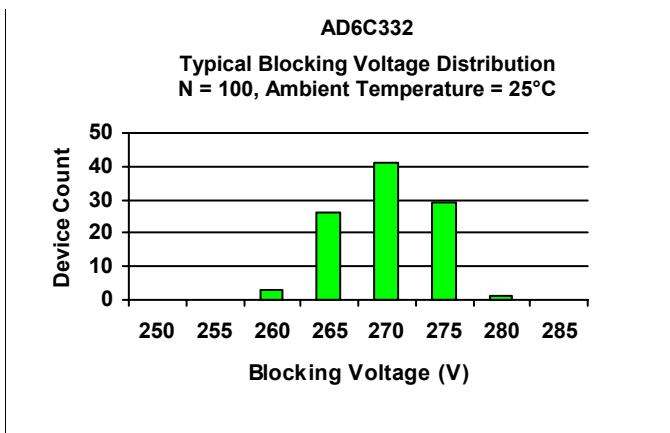
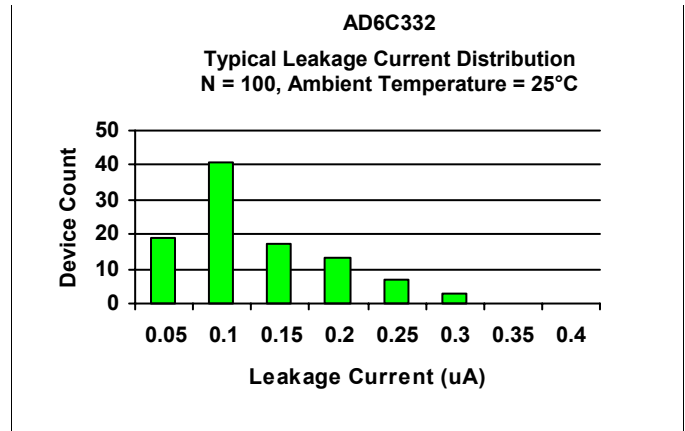
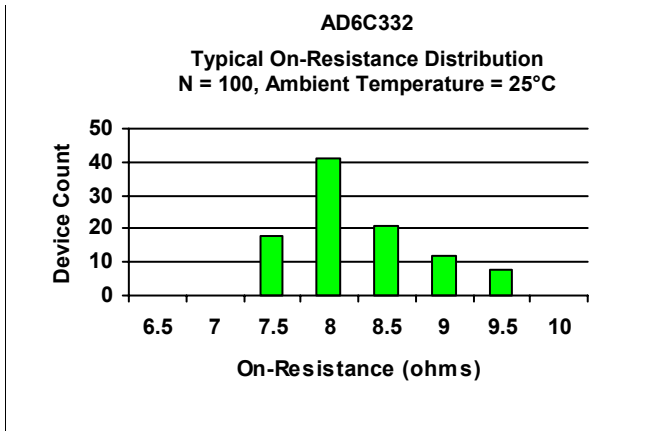
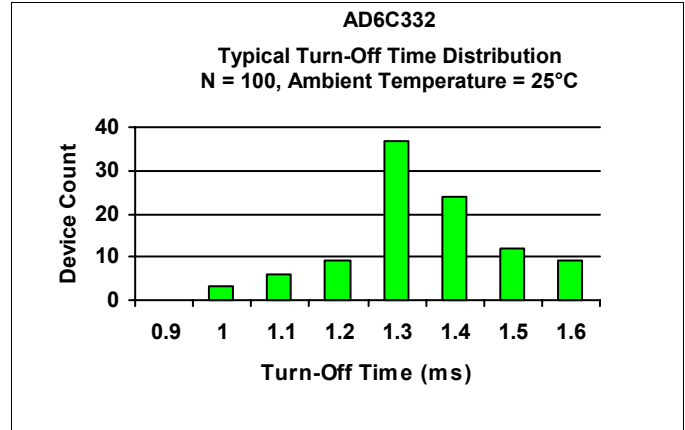
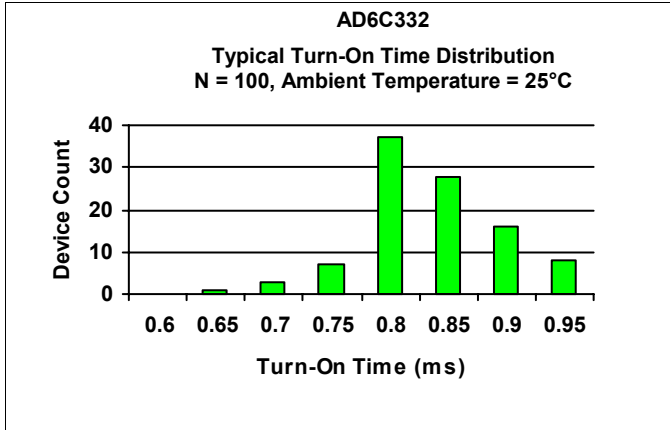

MECHANICAL DIMENSIONS

6 PIN DUAL IN-LINE PACKAGE

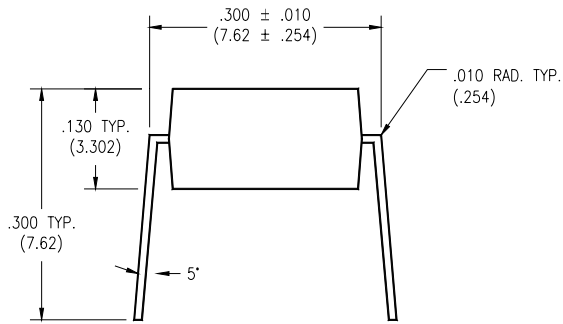

END VIEW

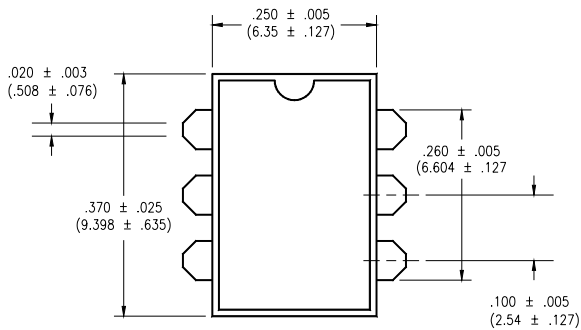

TOP VIEW

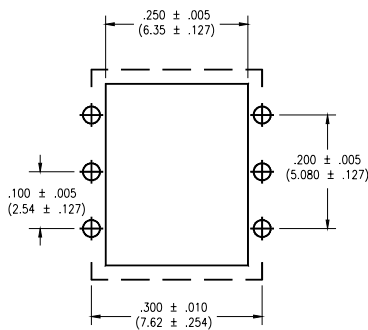

**BOTTOM VIEW/
BOARD PATTERN**

6 PIN SURFACE MOUNT DEVICE

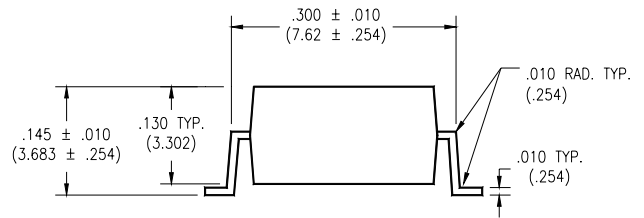

END VIEW

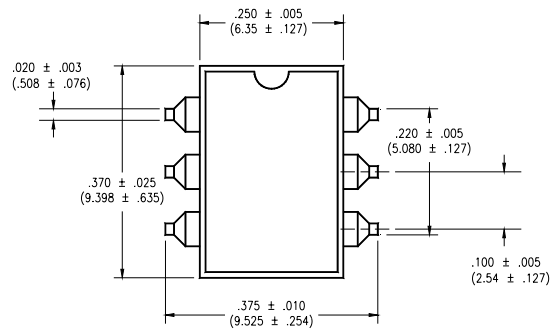

TOP VIEW

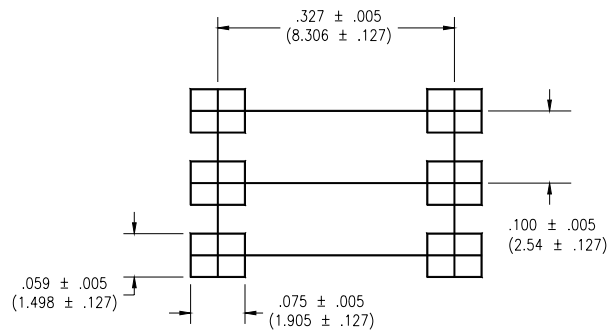

**BOTTOM VIEW/
BOARD PATTERN**

DISCLAIMER

Solid State Optronics (SSO) makes no warranties or representations with regards to the completeness and accuracy of this document. SSO reserves the right to make changes to product description, specifications at any time without further notice. SSO shall not assume any liability arising out of the application or use of any product or circuit described herein. Neither circuit patent licenses nor indemnity are expressed or implied. Except as specified in SSO's Standard Terms & Conditions, SSO disclaims liability for consequential or other damage, and we make no other warranty, expressed or implied, including merchantability and fitness for particular use.

LIFE SUPPORT POLICY

SSO does not authorize use of its devices in life support applications wherein failure or malfunction of a device may lead to personal injury or death. Users of SSO devices in life support applications assume all risks of such use and agree to indemnify SSO against any and all damages resulting from such use. Life support devices are defined as devices or systems which, (a) are intended for surgical implant into the body, or (b) support or sustain life, and (c) whose failure to perform when used properly in accordance with instructions for use can be reasonably expected to result in significant injury to the user, or (d) a critical component in any component of a life support device or system whose failure can be reasonably expected to cause failure of the life support device or system, or to affect its safety or effectiveness.