

New! R SERIES SNAP-IN ROCKER SWITCHES

FEATURES

- Cost effective illuminated or non-illuminated models.
- Single pole & double pole maintained or momentary action models.
- Actuator and case color selections.
- Standard actuator marking options.

SPECIFICATIONS

Contact ratings:	16A 125VAC 1/4 HP (UL/CSA). 16A 250VAC 1/4 HP (UL/CSA). 20A 125VAC 3/4 HP 250VAC (UL) 16(4)A 250V ~ T125 1E4 10(2)A 250V ~ 5E4 (VDE, SEMCO, NEMCO, DEMCO, FIMCO, SEV).
Initial contact resistance:	20 milliohms max.
Insulation resistance:	100 megohms min. at 500 V
Dielectric strength:	1000 VAC for 1 minute
Electrical life:	16(4)A 250VAC: 10,000 cycles 10(2)A 250VAC: 50,000 cycles
Operating temperature range:	-20°C to 125°C

MATERIALS

Contacts:	Silver cadmium alloy	Lamps:	Neon or fluorescent.
Terminals:	Silver plated copper		Illumination available
Actuator:	Nylon type 66 (UL94V-2 min.)		only with function 1 (ON OFF).
Case:	Nylon type 66 (UL94V-2 min.)		

AGENCY RECOGNITION



UL, CSA, VDE, SEMKO, NEMKO, DEMKO, FEMKO, & SEV. Models are supplied with agency markings.

Single pole - quick connect terminals - curved actuator



MODEL NO.	CIRCUIT	
R1101C2NBB	ON	OFF
R1201C2NBB	ON	ON
R1301C2NBB	ON	OFF ON
R1401C2NBB	(ON)	OFF
R1501C2NBB	(ON)	ON
R1601C2NBB	(ON)	OFF (ON)
R1701C2NBB	(ON)	OFF ON

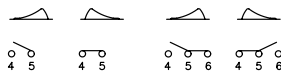

Parenthesis indicates momentary action. Models in table have black actuator and black case.

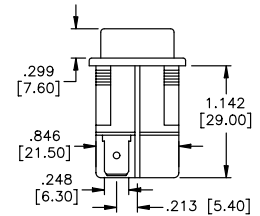
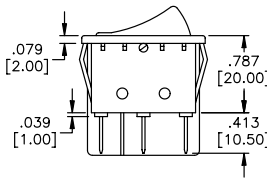
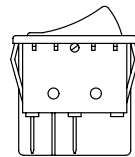
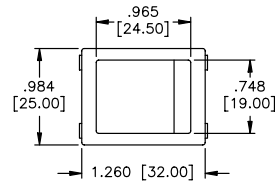

Double pole - quick connect terminals - curved actuator



MODEL NO.	CIRCUIT	
R2101C2NBB	ON	OFF
R2201C2NBB	ON	ON
R2301C2NBB	ON	OFF ON
R2401C2NBB	(ON)	OFF
R2501C2NBB	(ON)	ON
R2601C2NBB	(ON)	OFF (ON)
R2701C2NBB	(ON)	OFF ON

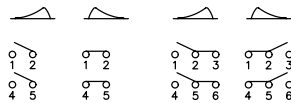

Parenthesis indicates momentary action. Models in table have black actuator and black case.

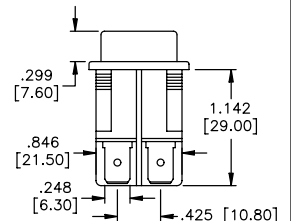
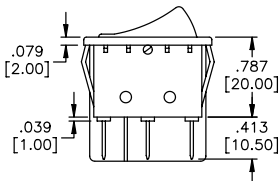
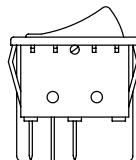
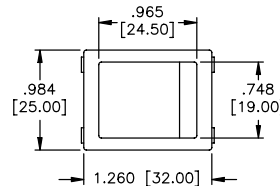

New! R SERIES SNAP-IN ROCKER SWITCHES

N

Double pole - illuminated - quick connect terminals - flat actuator



MODEL NO.	CIRCUIT
R2101F2LB0	ON OFF
R2201F2LB0	ON ON
R2401F2LB0	(ON) OFF
R2501F2LB0	(ON) ON

*Flat actuator not available in 3 position.

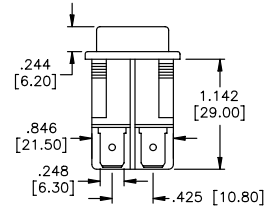
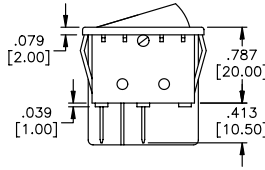
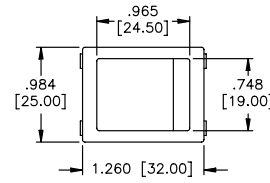

Parenthesis indicates momentary action. Models in table have orange actuator and black case.

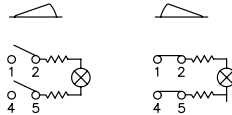

Additional ordering information: Commonly ordered models are shown above with complete model numbers and specifications. Below is an order format that enables you to 'build your own switch' and specify the correct switch model number by simply selecting from all available options shown and filling in the boxes.

'BUILD YOUR OWN SWITCH' ORDER FORMAT

Fill in boxes with selections shown for complete model number.
Allowable selections are shown below each respective box.
Note 'NONE' indicates box may be left empty.

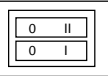
Series	Number of poles	Electrical functions	Terminals	Actuator shape	Actuator type	Marking/ lens color
<input type="text" value="R"/>	<input type="text" value="2"/>	<input type="text" value="2"/>	<input type="text" value="0"/>	<input type="text" value="1"/>	<input type="text" value="F"/>	<input type="text" value="1"/>
	1 Single pole 2 Double pole	1 ON OFF 2 ON ON *3 ON OFF ON 4 (ON) OFF 5 (ON) ON *6 (ON) OFF (ON) *7 (ON) OFF ON <small>parenthesis = momentary *Not available with flat actuator</small>	0 Quick-connect 1 Solder lug 3 Screw type	1 Single 2 Twin	C Curved F Flat Note: only flat actuator is available with full illumination-i.e.-no lens	1 HI LO 2 No marking 3 ON OFF 4 O I 5 O — 6 O II TWIN ACTUATORS: 7 
Illuminated type	Case color	Actuator color	Waterproof cover			
<input type="text" value="L"/>	<input type="text" value="A"/>	<input type="text" value="A"/>	<input type="text" value="NONE"/>			
L Illuminated N non-illum. C round lens <input type="checkbox"/> R square lens <input type="checkbox"/>	A Gray B Black W White	A Gray B Black G Green O Orange R Red W White	(NONE) W Waterproof			

Example of completely specified model number:
R2301C6NBRW

TERMINALS

PANEL CUT-OUTS

QUICK-CONNECT

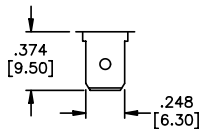

0

SOLDER LUG

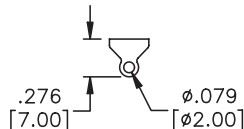

1

SCREW

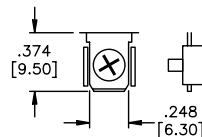

3

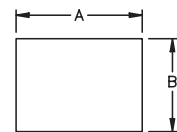

pnl. tk'ness.	A +0, -.004	B +.006, -.0
.029-.049"	1.181"	.866"
.050-.078"	1.189"	.866"
.079-.118"	1.200"	.866"