

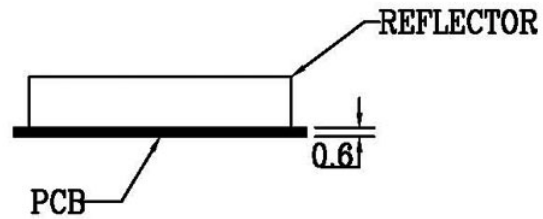

PACKAGE DIMENSIONS

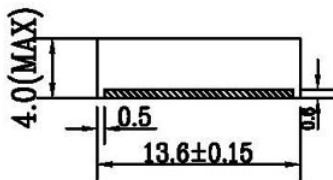
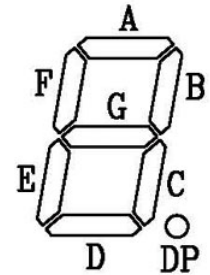
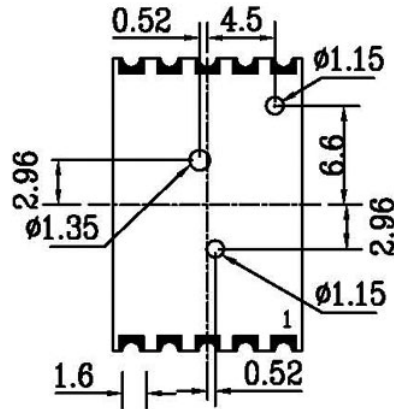
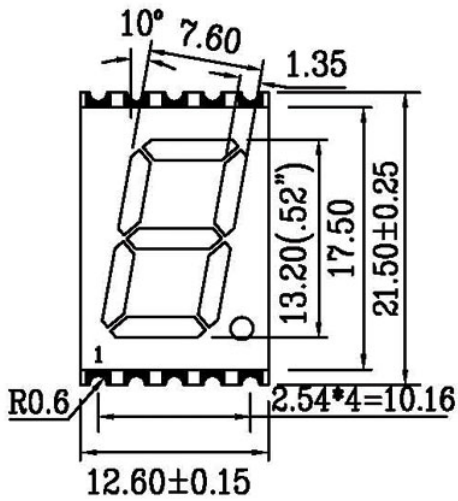

NOMARL TOLERANCE:±0.10 ANGLE:±1°

INTERNAL CIRCUIT DIAGRAM

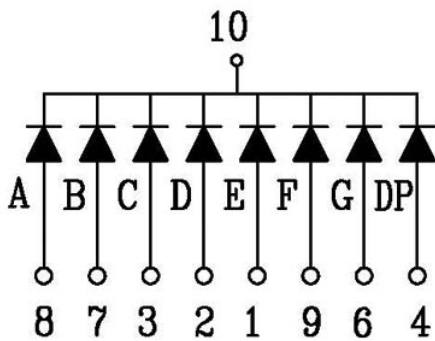

SC10-052SX-TXX

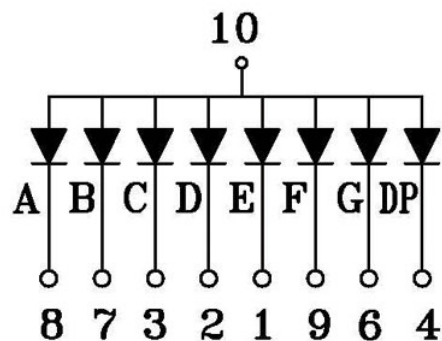

SA10-052SX-TXX

5 NO CONNECT