

FEATURES

- Fully qualified to Class H or K
- -55° to +125°C operation
- 19 to 40 VDC input
- Fully Isolated
- Magnetic feedback
- Fixed frequency, 600 kHz typical
- Topology – Single Ended Forward
- Inhibit function – input and output
- Sync function
- Output trim on single output models
- Indefinite short circuit protection
- Remote sense on single output models
- Up to 87% efficiency
- Parallelable up to 270 watts

DC/DC CONVERTERS

28 VOLT INPUT

SMFLHP SERIES

100 WATT



MODELS	
VDC OUTPUT	
SINGLE	DUAL
3.3	±5
5	±12
12	±15
15	

Size (max.): 3.005 x 1.505 x 0.400 inches (76.33 x 38.23 x 10.16 mm)

See cases "U maximum dimensions" and "U" for dimensions.

Weight: 86 grams maximum

Screening: Space Prototype, Class H, or Class K

Radiation hardness levels O or R

See "QA Screening: Class H and K, QML" for more information.

Available configurations: OO, HO, HR, KR

DESCRIPTION

The SMFLHP Series™ 28 volt DC/DC converters are rated up to 100 watts output power over a -55° to +125°C temperature range with a 28 Vdc nominal input. On dual output models, up to 70% of the rated output power can be drawn from either the positive or negative outputs. Current sharing allows the units to be paralleled for total power of up to 270 watts. The welded, hermetically sealed package is only 3.005 x 1.505 x 0.400 inches, giving the series an overall power density of up to 67 watts per cubic inch.

SCREENING

SMFLHP converters offer screening options to Space Prototype (O), Class H, or Class K. Available radiation hardness (RHA) levels are O or R. See "QA Screening: Class H and K, QML" for more information.

DESIGN FEATURES

The SMFLHP Series converters are switching regulators that use a quasi-square wave, single ended forward converter design with a constant switching frequency of 600 kHz.

Isolation between input and output circuits is provided with a transformer in the forward path and wide bandwidth magnetic coupling in the feedback control loop. The SMFLHP Series uses a unique dual loop feedback technique that controls output current with an inner feedback loop and output voltage with a cascaded voltage mode feedback loop.

The additional secondary current mode feedback loop improves transient response in a manner similar to primary current mode control and allows for ease of paralleling.

Tight load regulation is achieved through a wide-bandwidth magnetic feedback circuit. The output voltage on single SMFLHP models can be easily trimmed by adding an external resistor. (See Figure 1 for voltage changes with different resistor values.)

INHIBIT

The SMFLHP Series converters have two TTL compatible inhibit terminals (INH1 and INH2) that can be used to disable power conversion, resulting in a very low quiescent input current. An open collector TTL compatible low (<0.8 volts) is required between INH1 (pin 4) and Input Common (pin 2) to inhibit the converter. An open collector TTL compatible low (<0.5 volts) is required between INH2 (pin 12) and Output Common (pin 8) to inhibit the converter. The application of intermediate voltages to these pins (1.5 to 10.5 volts) should be avoided.

CURRENT SHARING AND PARALLEL OPERATION

Multiple SMFLHP converters may be used in parallel to drive a common load (see Figure 2). In this mode of operation the load current is shared by two or three SMFLHP converters. In current sharing mode, one SMFLHP converter is designated as a master. The SLAVE pin (pin 11) of the master is left unconnected and the MSTR/INH2 pin (pin 12) of the master is connected to the SLAVE pin (pin 11) of the slave units. The units designated as slaves have the MSTR/INH2 pin (pin 12) connected to the SNS RTN pin (pin 9). Figure 2 shows the typical setup for two or three units in parallel. Note that synchronizing the units together (though shown in the figure) is not required for current sharing operation. A second slave unit may be placed in parallel with a master and slave; this requires the TRI pin (pin 3) of the master unit to be connected to the SNS RTN pin (pin 9).

When paralleled, 90% of the total combined power ratings of the SMFLHP converters are available at the load. Overload and short circuit performance are not adversely affected during parallel operation.



Contact Information Interpoint, a Crane Co. Company
PO Box 97005 • Redmond WA 98073-9705
425-895-4053 • electronics@craneae.com
www.craneae.com/power

SMFLHP SERIES

100 WATT

DC/DC CONVERTERS

ABSOLUTE MAXIMUM RATINGS

- Input Voltage**
- 0 to 40 VDC
- Power Dissipation (Pd)**
- 20 watts
- Output Power**
- 80 to 100 watts depending on model
- Lead Soldering Temperature (10 sec per lead)**
- 300°C
- Storage Temperature Range (Case)**
- -65°C to +150°C

RECOMMENDED OPERATING CONDITIONS

- Input Voltage Range**
- 19 to 40 VDC continuous
 - 50 V for 50 msec transient
- Case Operating Temperature (Tc)**
- -55 to +125°C full power
 - -55 to +135°C absolute
- Derating Output Power/Current**
- Linearly from 100% at 125°C to 0% at 135°C

SYNC IN AND INHIBIT (INH1, INH2)

- Sync In (525 to 675 kHz)**
- Duty cycle 40% min, 60% max
 - Logic low 0.8 V max
 - Logic high 4.5 V min
 - Referenced to input common
 - If not used, connect to input common
- Sync Out - Referenced to input common**
- Inhibit (INH1, INH2) TTL Open Collector**
- Logic low (output disabled)
Current -10 to -5 mA
INH1 referenced to input common
Logic low 0.8 V max
INH2 referenced to output common
Logic low 0.5 V max
 - Logic high (output enabled)
Open collector

TYPICAL CHARACTERISTICS

- Output Voltage Temperature Coefficient**
- 100 ppm/°C typical
- Input to Output Capacitance**
- 150 pF typical
- Isolation**
- 100 megohm minimum at 500 V
- Audio Rejection**
- 50 dB typical
- Conversion Frequency**
- Free run mode 600 kHz typical
550 kHz min, 650 kHz max
 - External sync range 525 to 675 kHz
- Inhibit Pin Voltage (unit enabled)**
- INH1 = 9 to 12 V, INH2 = 6 to 9 V

PINS NOT IN USE

- | | |
|-----------------------|--|
| TR1 | No connection |
| Inhibit (INH1) | No connection |
| Sync Out | No connection |
| Sync In | Connect to output common |
| Sense Lines | Must be connected to appropriate outputs |
| Slave | No connection |
| MSTR (INH 2) | No connection |

Electrical Characteristics: -55°C to +125°C Tc, 28 VDC Vin, 100% load, free run, unless otherwise specified.

SINGLE OUTPUT MODELS		SMFLHP283R3S			SMFLHP2805S			SMFLHP2812S			SMFLHP2815S			UNITS
PARAMETER	CONDITION	MIN	TYP	MAX	MIN	TYP	MAX	MIN	TYP	MAX	MIN	TYP	MAX	
OUTPUT VOLTAGE	25°C	3.26	3.3	3.34	4.95	5.00	5.05	11.88	12.00	12.12	14.85	15.00	15.15	VDC
OUTPUT CURRENT	V _{IN} = 19 to 40 VDC	0	—	18	0	—	16	0	—	7.5	0	—	6.67	A
OUTPUT POWER	V _{IN} = 19 to 40 VDC	0	—	60	0	—	80	0	—	90	0	—	100	W
OUTPUT RIPPLE	Tc = 25°C	—	10	45	—	15	50	—	30	85	—	30	95	mV p-p
VOLTAGE 10 k - 2 MHz	Tc = -55°C to +125°C	—	20	80	—	30	90	—	45	150	—	45	175	
LINE REGULATION	V _{IN} = 19 to 40 VDC	—	0	50	—	0	50	—	0	50	—	0	50	mV
LOAD REGULATION	NO LOAD TO FULL	—	0	20	—	0	20	—	0	20	—	0	20	mV
INPUT VOLTAGE	CONTINUOUS	19	28	40	19	28	40	19	28	40	19	28	40	VDC
NO LOAD TO FULL	TRANSIENT ¹ 50 ms	—	—	50	—	—	50	—	—	50	—	—	50	V
INPUT CURRENT	NO LOAD	—	70	120	—	70	120	—	50	80	—	50	80	mA
	FULL LOAD	—	2.9	3.1	—	3.6	3.73	—	3.8	3.95	—	4.2	4.40	
	INHIBITED - INH1	—	9	15	—	9	15	—	9	15	—	9	15	
	INHIBITED - INH2	—	35	80	—	35	80	—	35	80	—	35	80	
INPUT RIPPLE CURRENT	10 kHz - 10 MHz	—	30	80	—	30	80	—	30	80	—	30	80	mA pp
EFFICIENCY	Tc = 25°C	70	72	—	77	80	—	81	86	—	82	87	—	%
LOAD FAULT	POWER DISSIPATION													
Tc = 25°C	SHORT CIRCUIT	—	15	20	—	15	20	—	15	20	—	15	20	W
	RECOVERY	—	1.5	4	—	1.5	4	—	1.5	4	—	1.5	4	ms
STEP LOAD RESP.	50% - 100% - 50%													
	TRANSIENT	—	350	450	—	350	450	—	450	700	—	450	700	mV pk
	RECOVERY ²	—	1.5	3.0	—	1.5	3.0	—	1.5	3.0	—	1.5	3.0	ms
STEP LINE RESP.	19 - 40 - 19 VDC													
	TRANSIENT ³	—	250	400	—	250	400	—	250	400	—	250	400	mV pk
	RECOVERY ²	—	200	600	—	200	600	—	200	600	—	200	600	μs
START-UP	DELAY	—	3.5	10	—	3.5	10	—	3.5	10	—	3.5	10	ms
	OVERSHOOT	—	0	25	—	0	25	—	0	50	—	0	50	mV pk

Notes

1. Unit will shut down above approximately 45V but will be undamaged and will restart when voltage drops into normal range.
2. Recovery time is measured from application of the transient to point at which V_{out} is within 1% of final value.
3. Transition time ≥ 10 μs.



DC/DC CONVERTERS

SMFLHP SERIES

100 WATT

Electrical Characteristics: -55°C to $+125^{\circ}\text{C}$ T_c , 28 VDC V_{in} , 100% load, free run, unless otherwise specified.

DUAL OUTPUT MODELS		SMFLHP2805D			SMFLHP2812D			SMFLHP2815D			UNITS
PARAMETER	CONDITIONS	MIN	TYP	MAX	MIN	TYP	MAX	MIN	TYP	MAX	
OUTPUT VOLTAGE $T_c = 25^{\circ}\text{C}$	$+V_{OUT}$	4.95	5.00	5.05	11.88	12.00	12.12	14.85	15.00	15.15	VDC
	$-V_{OUT}$	4.92	5.00	5.08	11.82	12.00	12.18	14.77	15.00	15.23	
OUTPUT CURRENT ¹ $V_{IN} = 19$ to 40 VDC	EACH OUTPUT	0	—	11.2	0	—	5.3	0	—	4.67	A
	TOTAL	0	—	16.0	0	—	7.5	0	—	6.67	
OUTPUT POWER ¹ $V_{IN} = 19$ to 40 VDC	EACH OUTPUT	0	—	56	0	—	63	0	—	70	W
	TOTAL	0	—	80	0	—	90	0	—	100	
OUTPUT RIPPLE VOLTAGE	10 kHz - 2 MHz										mV p-p
	$+V_{OUT}$	—	25	150	—	50	175	—	50	225	
	$-V_{OUT}$	—	25	150	—	50	175	—	50	225	
LINE REGULATION $V_{IN} = 19$ to 40 VDC	$+V_{OUT}$	—	0	50	—	0	50	—	0	50	mV
	$-V_{OUT}$	—	25	100	—	25	100	—	25	100	
LOAD REGULATION NO LOAD TO FULL	$+V_{OUT}$	—	0	50	—	10	100	—	10	100	mV
	$-V_{OUT}$	—	25	100	—	50	200	—	50	200	
INPUT VOLTAGE NO LOAD TO FULL	CONTINUOUS	19	28	40	19	28	40	19	28	40	VDC
	TRANSIENT ² 50 ms	0	—	50	0	—	50	0	—	50	V
INPUT CURRENT $T_c = 25^{\circ}\text{C}$	NO LOAD	—	50	120	—	50	120	—	550	120	mA
	FULL LOAD	—	3.6		—	3.8		—	4.2		A
	INHIBITED - INH1	—	9	14	—	9	14	—	9	14	mA
	INHIBITED - INH2	—	35	80	—	35	80	—	35	80	
INPUT RIPPLE CURRENT	10 kHz - 10 MHz	—	30	80	—	30	80	—	30	80	mA p-p
EFFICIENCY 25°C T_c	BALANCED LOAD	75	80	—	81	86	—	82	87	—	%
LOAD FAULT $T_c = 25^{\circ}\text{C}$	POWER DISSIPATION SHORT CIRCUIT	—	15	20	—	15	20	—	15	20	W
	RECOVERY	—	1.5	4.0	—	1.5	4.0	—	1.5	4.0	ms
STEP LOAD RESPONSE $\pm V_{OUT}$	50 %–100%– 50% LOAD TRANSIENT	—	350	450	—	450	700	—	450	700	mV pk
	RECOVERY ³	—	1.5	3.0	—	1.5	3.0	—	1.5	3.0	ms
STEP LINE RESPONSE $\pm V_{OUT}$	19 – 40 – 16 V_{IN} TRANSIENT ⁴	—	250	600	—	250	600	—	250	600	mV pk
	RECOVERY ³	—	200	300	—	200	300	—	200	300	μs
START-UP	DELAY	—	3.5	20	—	3.5	20	—	3.5	20	ms
	OVERSHOOT	—	0	25	—	0	50	—	0	50	mV p

Notes

- Up to 70% of the total output power (current) is available from either output provided the opposite output is carrying 30% of the power (current) in use.
- Unit will shut down above approximately 45V but will be undamaged and will restart when voltage drops into normal range.
- Recovery time is measured from application of the transient to point at which V_{out} is within 1% of final value.
- Transition time $\geq 10 \mu\text{s}$.



SMFLHP SERIES 100 WATT

DC/DC CONVERTERS

SINGLE OUTPUT MODELS CONNECTION DIAGRAMS - SENSE AND PARALLEL

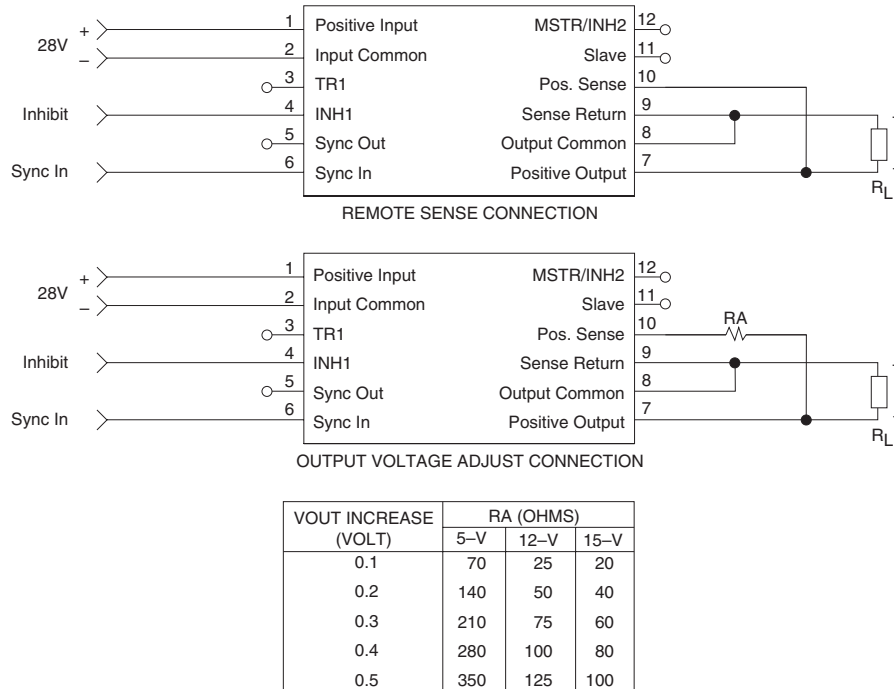

FIGURE 1: SENSE CONNECTIONS AND TRIM TABLE

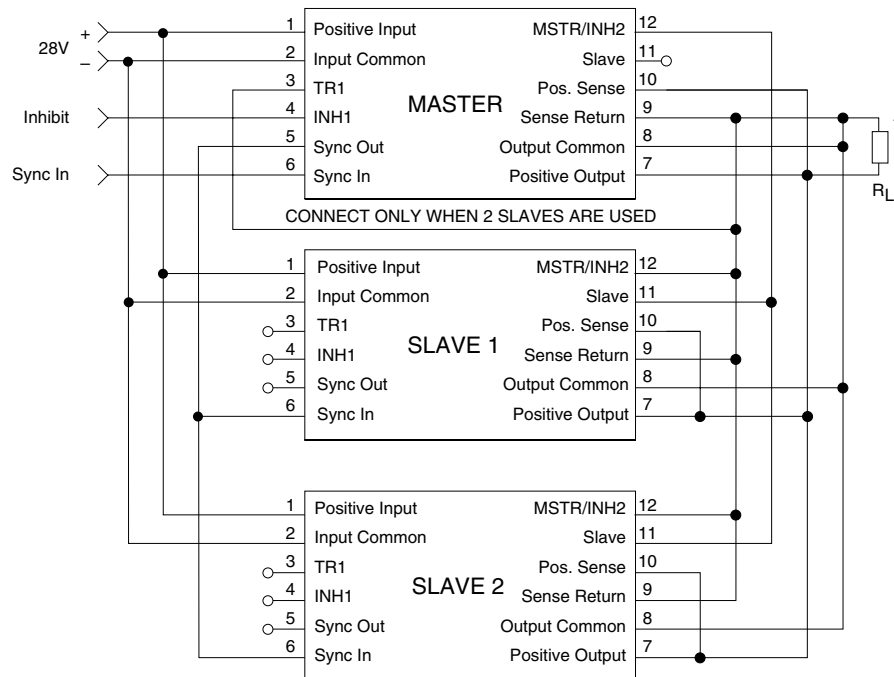
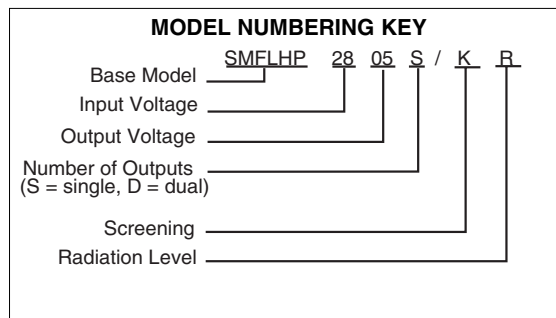
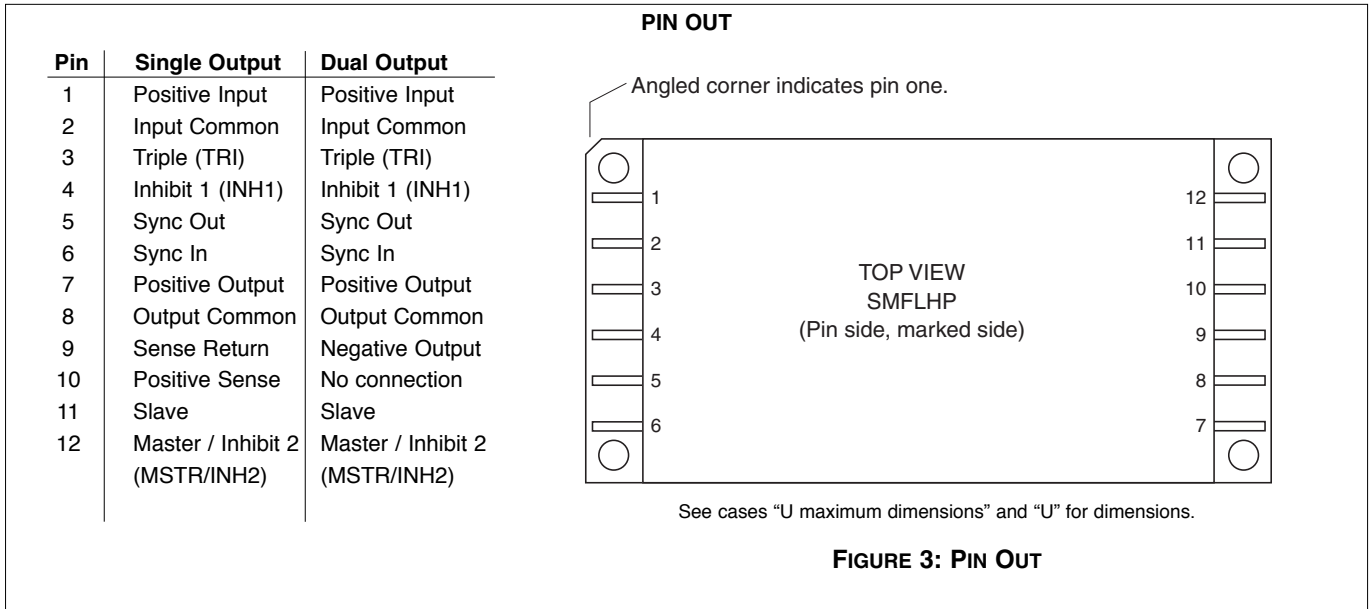

FIGURE 2: PARALLEL CONNECTIONS



Typical Performance Curves: 25°C Tc , 28 VDC Vin, 100% load, free run, unless otherwise specified.

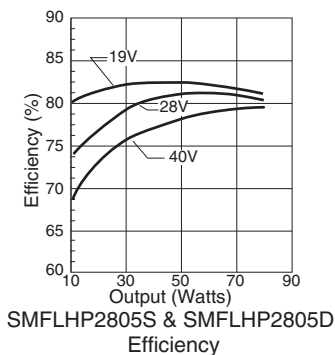

FIGURE 4

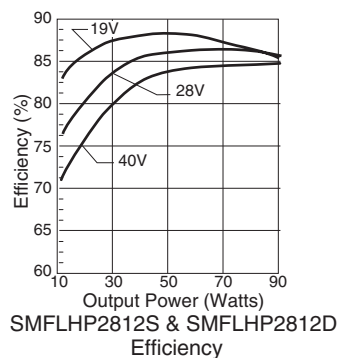

FIGURE 5

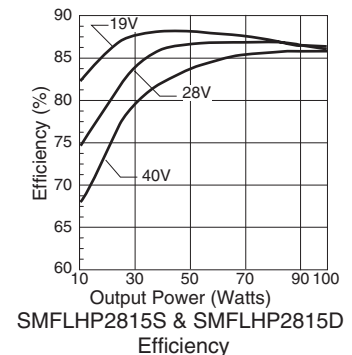

FIGURE 6

SMFLHP SERIES 100 WATT

DC/DC CONVERTERS

Typical Performance Curves: 25°C Tc , 28 VDC Vin, 100% load, free run, unless otherwise specified.

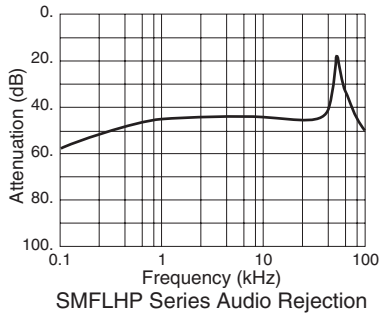

FIGURE 7

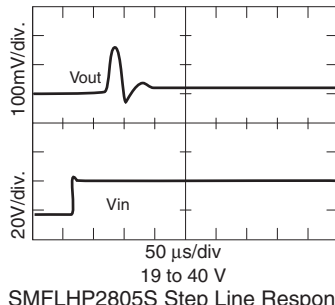

FIGURE 8

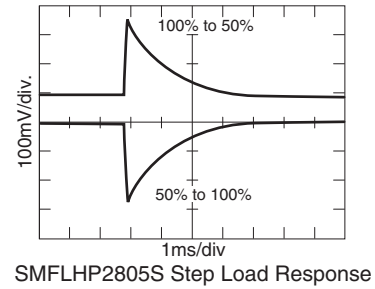

FIGURE 9

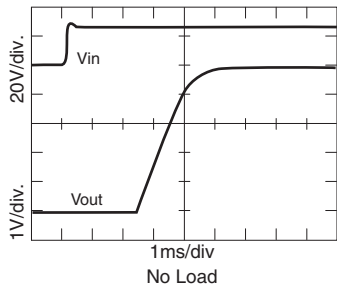

FIGURE 10

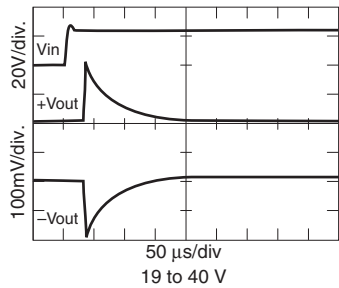

FIGURE 11

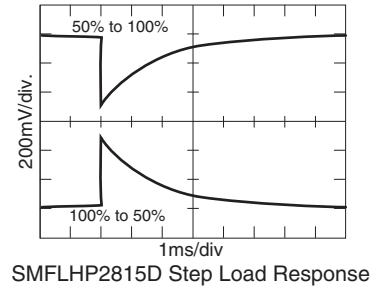

FIGURE 12

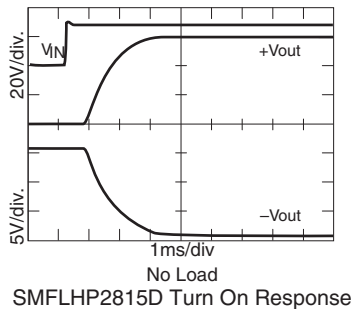

FIGURE 13

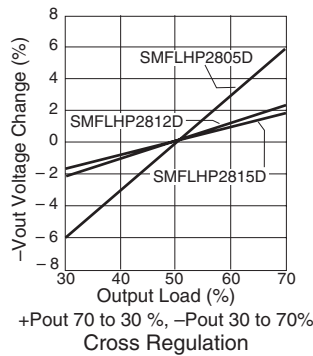

FIGURE 14

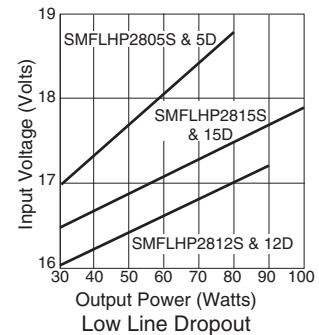

FIGURE 15

SMFLHP Rev G (input ripple - error) October 6, 2005. This revision supercedes all previous releases. All technical information is believed to be accurate, but no responsibility is assumed for errors or omissions. Interpoint reserves the right to make changes in products or specifications without notice. SMFLHP Series is a trademark of Interpoint. Copyright © 1999-2005 Interpoint. All rights reserved.

