

Fusible Metal Film Resistors

FM Series

- Predictable fusing characteristics
- Flameproof protection

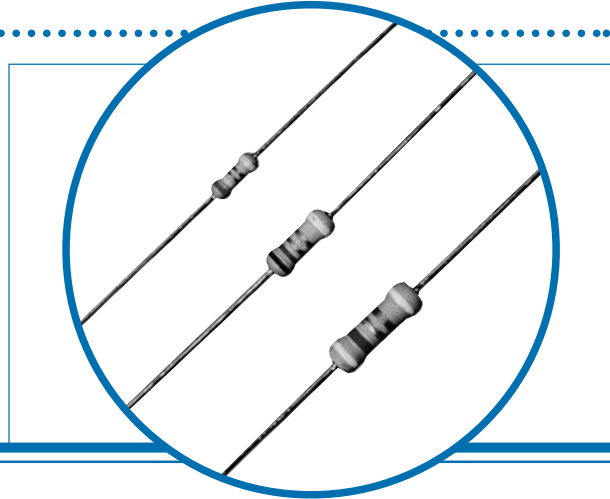

Electrical Data

		FM1/4	FM1/2	FM1
Power rating at 70° C	watt	0.25	0.5	1.0
Resistance range	ohms	0R1 - 10K	0R1 - 27K	0R2 - 1K5
Limiting element voltage	volts	250	350	350
TCR	ppm/° C		250	
Resistance tolerance	%		5	
Standard values		E24 preferred		
Thermal impedance	° C/watt	150	120	100
Ambient temperature range	° C	-55 to 155		

Physical Data

Dimensions (mm) & Weight (g)							
Type	L max	D max	f min	d nom	PCB mounting centres	Min. bend radius	Wt. nom
FM1/4	6.2	2.5	21.0	0.6	10.2	0.6	0.3
FM1/2	9.0	3.4	19.6	0.8	12.7	1.2	0.6
FM1	12.5	4.2	17.8	0.8	18.4	1.2	0.9

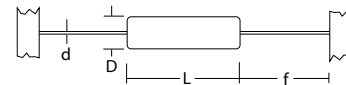

Construction

The metal film is deposited on a high purity ceramic rod. End caps are force fitted and termination wires welded to the caps. The resistive film is adjusted to the required value by a special helical cut; finally the cement protection is applied to the resistor body and marked with indelible ink.

Terminations

- Material** Solder-coated copper wire.
- Strength** The terminations meet the requirements of IEC 68.2.21.
- Solderability** The terminations meet the requirements of IEC 115-1, Clause 4.17.3.2.

Marking

Resistors are colour coded with five bands. Four of the bands are used to indicate value and tolerance, with IEC 62 colours being used. A fifth yellow band denotes constant voltage fusibility.

Solvent Resistance

The body protection and marking are resistant to all normal industrial cleaning solvents suitable for printed circuits.

Flammability

The resistors will not burn or emit incandescent particles under any condition of applied temperature or power overload.

General Note

Welwyn Components reserves the right to make changes in product specification without notice or liability. All information is subject to Welwyn's own data and is considered accurate at time of going to print.

© Welwyn Components Limited · Bedlington, Northumberland NE22 7AA, UK
Telephone: +44 (0) 1670 822181 · Facsimile: +44 (0) 1670 829465 · Email: info@welwyn-tt.com · Website: www.welwyn-tt.com

Performance Data

		Maximum
Load: 1000 hours at 70°C	ΔR%	3
Shelf life: 12 months at room temperature	ΔR%	2
Derating from rated power at 70°C		zero at 155°C
Temperature rapid change	ΔR%	0.5
Resistance to solder heat	ΔR%	0.5

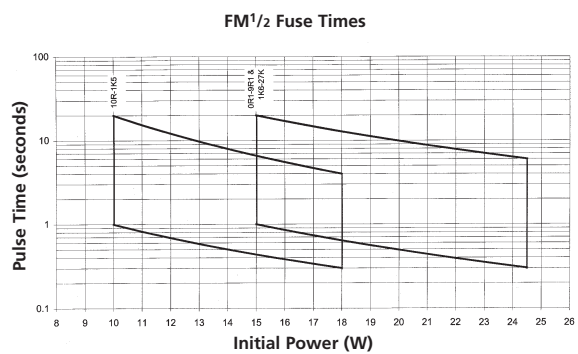
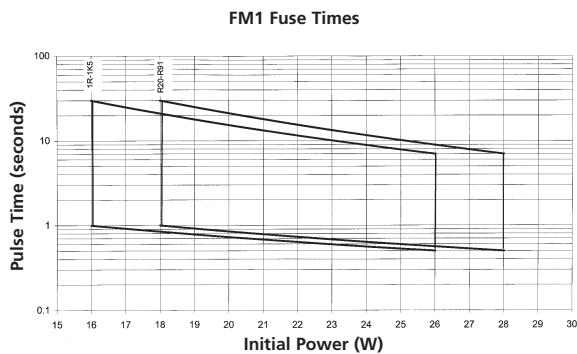

Packaging

All resistors are supplied tape packed ready for loading on to automatic sequencing and insertion machines.

The standard taping method and critical dimensions are shown in figure 1. Component wire will not protrude beyond the outside edge of the tapes.

Lead Formed resistors can also be supplied. Standard options of Lancet, Radial and Goalpost forming are shown in Lead Form Information section.

A detailed Packaging Data Sheet is available on request.

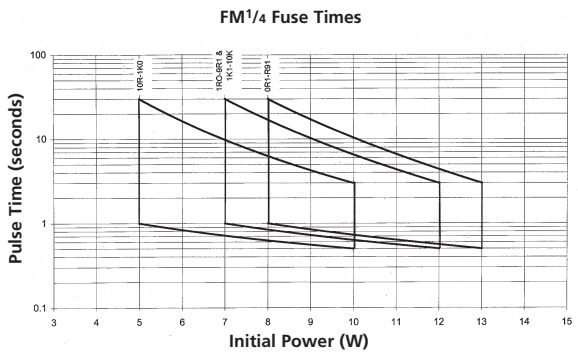
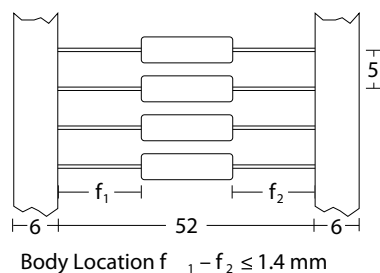

Figure 1



Fusing

After fusing the final resistance value will be ≥ 50 times the initial value.

Ordering Procedure

Example: FM½ at 4.7 kilohms and 5% tolerance in ammo pack box of 2500 pieces -

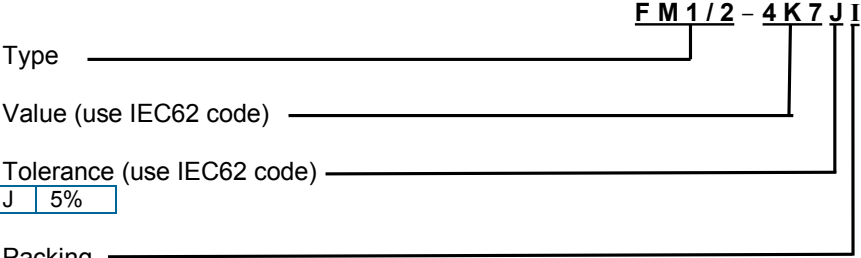

I	Ammo	FM¼	5000/box	Standard
		FM½	2500/box	
		FM1	1500/box	