

LS1-PBL1-01

Applications

- Optical indicators
- Coupling into light guides
- Back lights (LCD, switches, keys, displays, illuminated advertising, general lighting)
- Interior automotive lighting (dashboard backlighting)
- Marker lights (steps, exit ways)
- Signal and symbol luminaire
- Automotive applications

Maximum Ratings (Ta=25°C)

Characteristic	Symbol	Max.	Unit
Forward Current	I _F	20	mA
Reverse Voltage	V _R	5	V
Power Dissipation	P _D	85.00	mW
Operating Temperature	T _{opr}	-40 ~ +100	°C
Storage Temperature	T _{stg}	-40 ~ +100	°C
Soldering Temperature	T _{sol}	260	°C
Soldering Time	-	for 3 sec. max	-

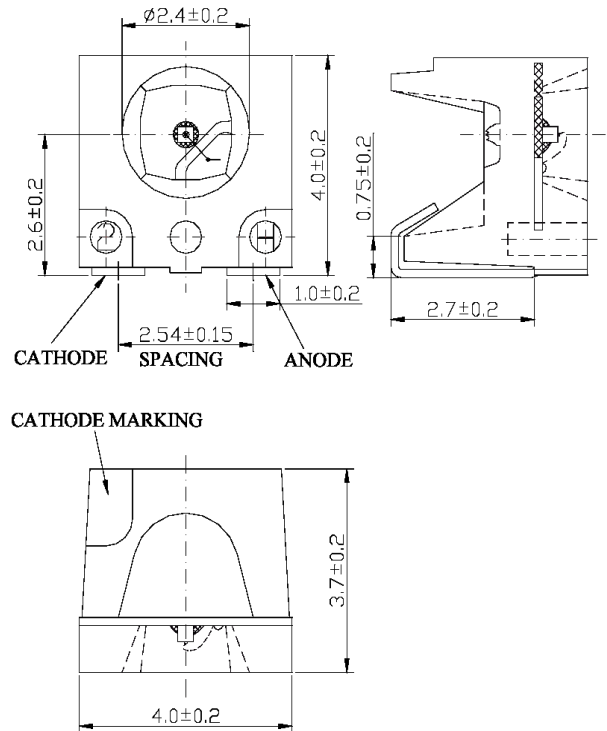

Dimensions are specified as follows: mm.

Opto-Electrical Characteristics (Ta=25°C)

Characteristic	Symbol	Test Condition	Min	Typ	Max	Unit
Forward Voltage	V _F	I _F =20mA	-	3.60	4.20	V
Reverse Current	I _R	V _R =5V	-	-	10	μA
Luminous Intensity	I _v	I _F =20mA	90.00	120.00	-	mcd
Viewing Angle	2θ ^{1/2}	-	-	120°	-	deg.
Peak Wavelength	λ _p	I _F =20mA	-	465	-	nm
Dominant Wavelength	λ _d	I _F =20mA	-	470	-	nm
Spectral Line Half Width	Δλ	I _F =20mA	-	28	-	nm

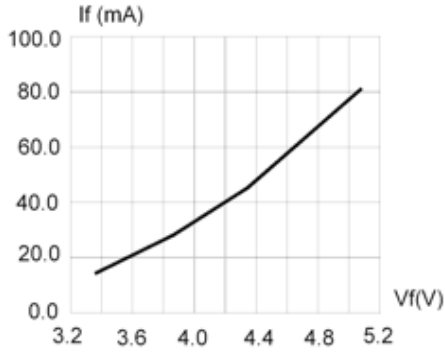

FIG.1 FORWARD CURRENT VS. FORWARD VOLTAGE.

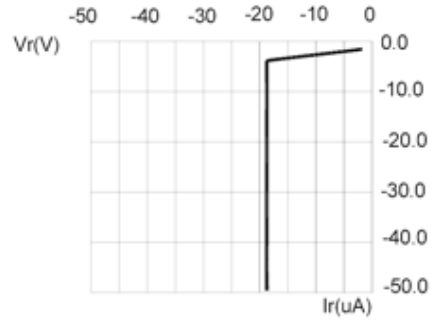

FIG.2 REVERSE CURRENT VS. REVERSE VOLTAGE.

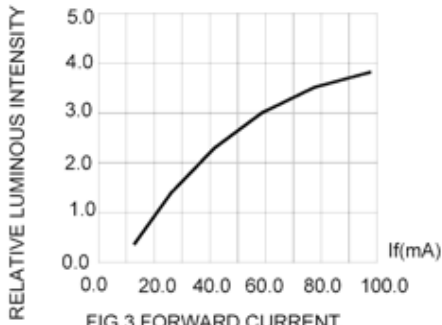

FIG.3 FORWARD CURRENT.

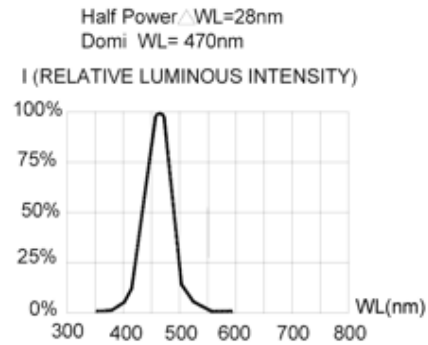

FIG.4 RELATIVE LUMINOUS INTENSITY VS. WAVELENGTH.

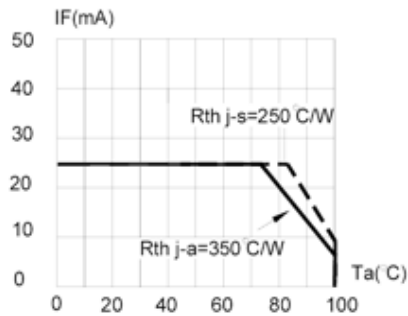

FIG.5 MAXIMUM FORWARD DC CURRENT VS TEMPERATURE. DERATING BASED ON $T_{jmax}=110^{\circ}C$

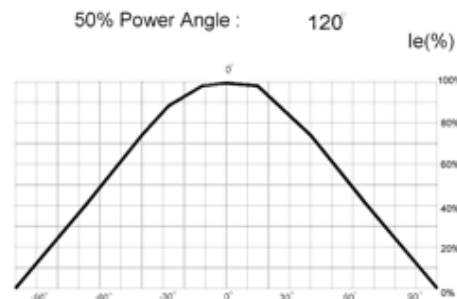

FIG.6 SPATIAL DISTRIBUTION.