

Audio Frequency Power Amplifier

SL1001

Features

- Low Speed Switching

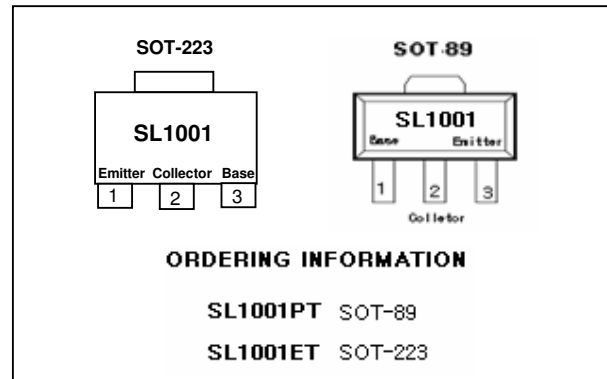

PNP Epitaxial Silicon Transistor

Absolute Maximum Ratings Tc=25°C unless otherwise noted

Symbol	Parameter	Value	Units
VCBO	Collector-Base Voltage	- 40	V
VCEO	Collector-Emitter Voltage	- 30	V
VEBO	Emitter-Base Voltage	- 5	V
IC	Collector Current (DC)	- 3	A
ICP	*Collector Current (Pulse)	- 7	A
IB	Base Current (DC)	- 0.6	A
PC	Collector Dissipation	(TC=25°C) 10	W
Rθja	Junction to Ambient	132	°C/W
Rθjc	Junction to Case	13.5	°C/W
TJ	Junction Temperature	150	°C
TSTG	Storage Temperature	- 55 ~ 150	°C

* PW≤10ms, Duty Cycle≤50%

Electrical Characteristics

 Tc=25°C unless otherwise noted

Characteristics	Symbol	Unit	Measurement Mode	Min	Max
DC Current Gain (1), (2)	h_{FE}		$V_{ce} = 2V, I_c = 20mA$	30	
DC Current Gain (1), (2)	h_{FE}		$V_{ce} = 2V, I_c = 1A$	60	400
Collector Cut-off Current	I_{cbo}	μA	$V_{cb} = 30V, I_e = 0$		1.0
Collector Cut-off Current	I_{cbo}	μA	$V_{cb} = 40V, I_e = 0$		100
Emitter Cut-off Current	I_{ebo}	μA	$V_{eb} = 3V, I_c = 0$		1.0
Emitter Cut-off Current	I_{ebo}	μA	$V_{eb} = 5V, I_c = 0$		100
Collector-Emitter Saturation Voltage (1)	$V_{ce(sat)}$		$I_c = 2 A, I_b = 0.2 A$		0.5
			$I_c = 0.8 A, I_b = 0.02 A$		0.1
Base-Emitter Saturation Voltage (1)	$V_{be(sat)}$		$I_c = 2 A, I_b = 0.2 A$		2.0

(1) Pulse Test : Pulse Width ≤ 300μs. Duty Cycle ≤ 2%

(2) Measurement mode for a network with common base : Vcb = 1V, Ie=Ic

Typical Characteristics

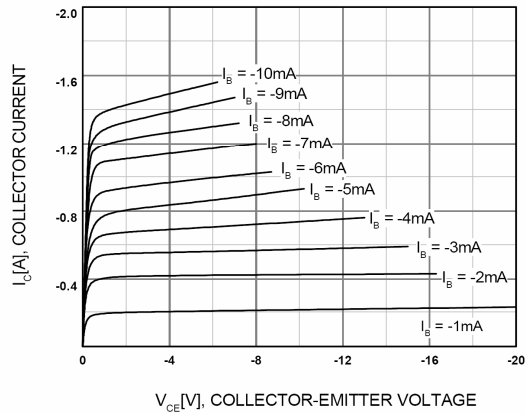

Figure 1. Static Characteristic

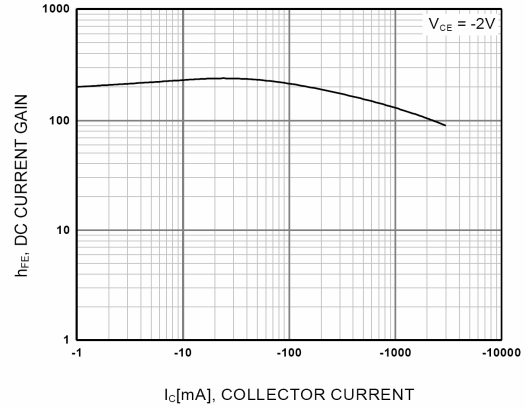

Figure 2. DC current Gain

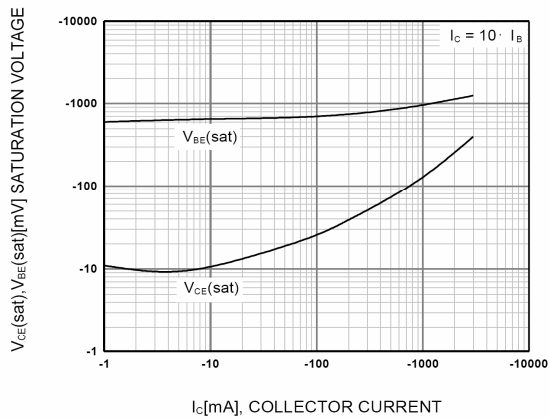

Figure 3. Base-Emitter Saturation Voltage
Collector-Emitter Saturation Voltage

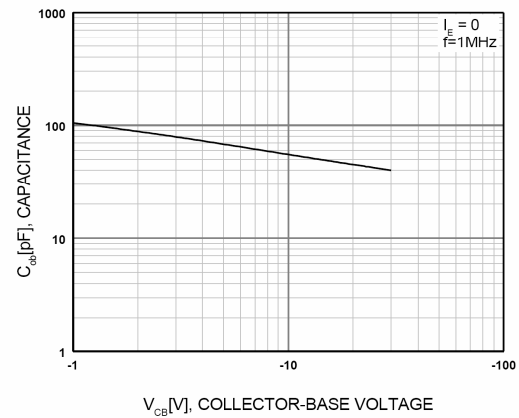

Figure 4. Collector Output Capacitance

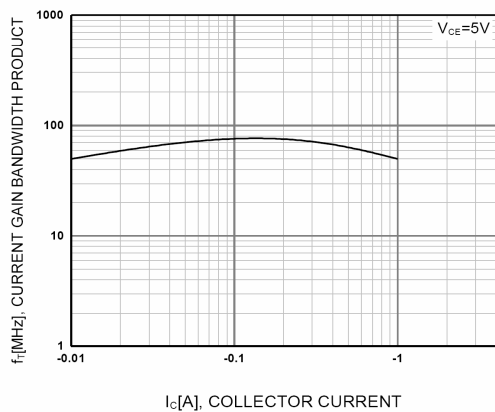

Figure 5. Current Gain Bandwidth Product

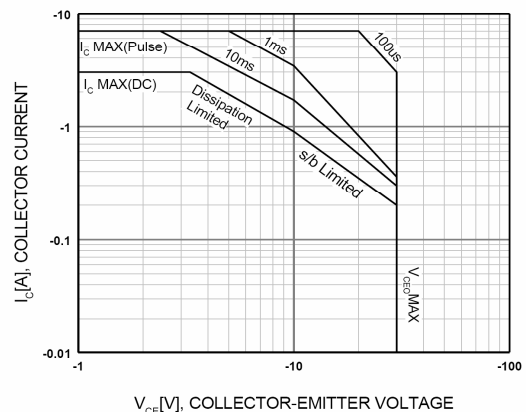

Figure 6. Safe Operating Area

Typical Characteristics (Continued)

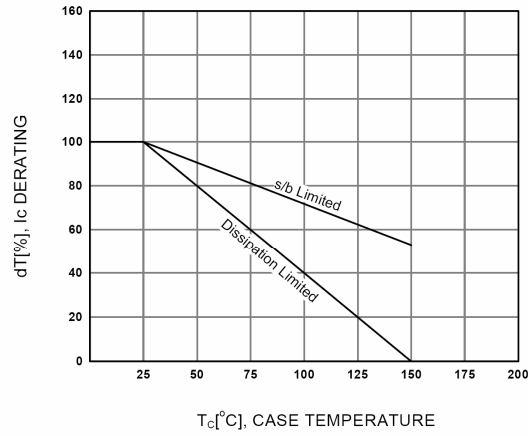

Figure 7. Derating Curve of Safe Operating Areas

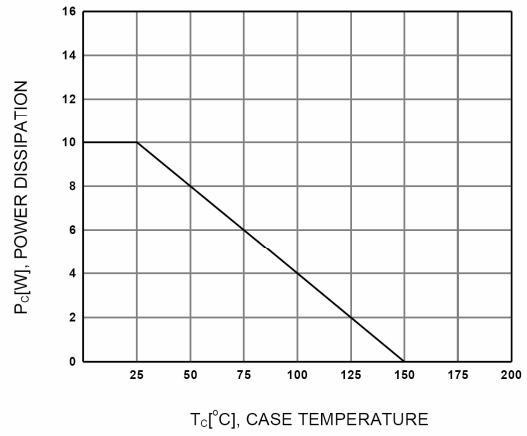
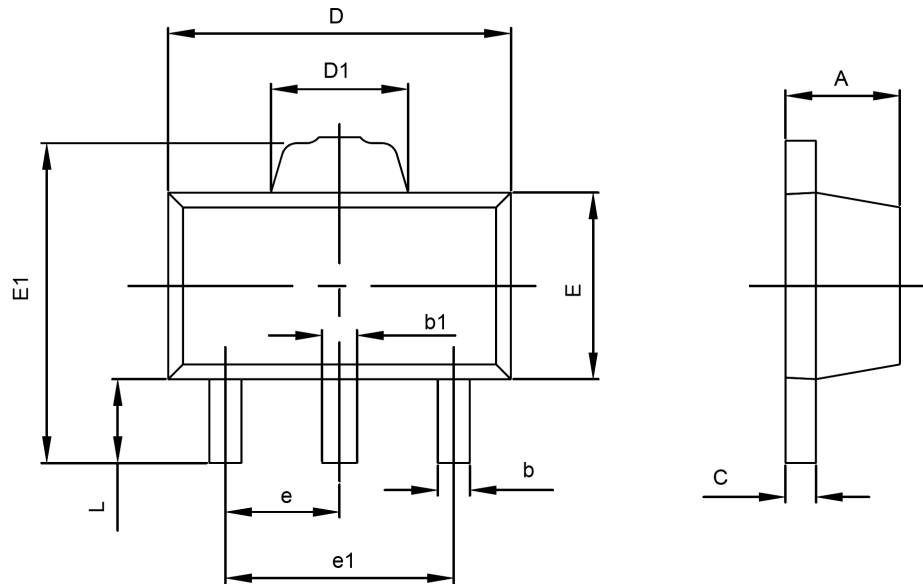

Figure 8. Power Derating

SOT-89-3L PACKAGE OUTLINE DIMENSIONS



Symbol	Dimensions In Millimeters		Dimensions In Inches	
	Min	Max	Min	Max
A	1.400	1.600	0.055	0.063
b	0.320	0.520	0.013	0.020
b1	0.360	0.560	0.014	0.022
c	0.350	0.440	0.014	0.017
D	4.400	4.600	0.173	0.181
D1	1.400	1.800	0.055	0.071
E	2.300	2.600	0.091	0.102
E1	3.940	4.250	0.155	0.167
e	1.500TYP		0.060TYP	
e1	2.900	3.100	0.114	0.122
L	0.900	1.100	0.035	0.043

SOT-223

