

2.0A SURFACE MOUNT SCHOTTKY BARRIER DIODE

Features

- Schottky Barrier Chip
- Ideally Suited for Automatic Assembly
- Low Power Loss, High Efficiency
- Surge Overload Rating to 50A Peak
- For Use in Low Voltage Application
- Guard Ring Die Construction
- Plastic Case Material has UL Flammability Classification Rating 94V-O

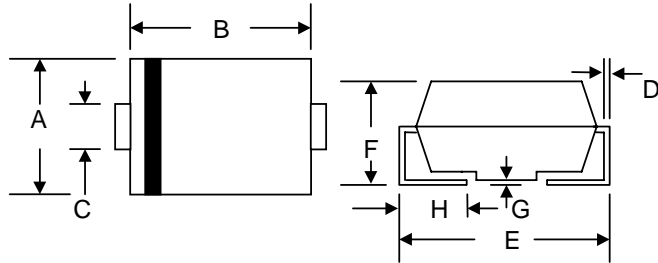

Mechanical Data

- Case: SMB/DO-214AA, Molded Plastic
- Terminals: Solder Plated, Solderable per MIL-STD-750, Method 2026
- Polarity: Cathode Band or Cathode Notch
- Marking: Type Number
- Weight: 0.093 grams (approx.)
- **Lead Free: For RoHS / Lead Free Version, Add "-LF" Suffix to Part Number, See Page 4**

SMB/DO-214AA		
Dim	Min	Max
A	3.30	3.94
B	4.06	4.70
C	1.91	2.11
D	0.152	0.305
E	5.08	5.59
F	2.13	2.44
G	0.051	0.203
H	0.76	1.27
All Dimensions in mm		

Maximum Ratings and Electrical Characteristics @ $T_A=25^{\circ}\text{C}$ unless otherwise specified

Characteristic	Symbol	SK22	SK23	SK24	SK25	SK26	SK28	SK29	S210	Unit	
Peak Repetitive Reverse Voltage	V_{RRM}	20	30	40	50	60	80	90	100	V	
Working Peak Reverse Voltage	V_{RWM}										
DC Blocking Voltage	V_R										
RMS Reverse Voltage	$V_{R(RMS)}$	14	21	28	35	42	56	64	71	V	
Average Rectified Output Current @ $T_L = 105^{\circ}\text{C}$	I_O	2.0								A	
Non-Repetitive Peak Forward Surge Current 8.3ms Single half sine-wave superimposed on rated load (JEDEC Method)	I_{FSM}	50								A	
Forward Voltage @ $I_F = 2.0\text{A}$	V_{FM}	0.50			0.70		0.85			V	
Peak Reverse Current @ $T_A = 25^{\circ}\text{C}$	I_{RM}	0.5								mA	
At Rated DC Blocking Voltage @ $T_A = 100^{\circ}\text{C}$		20									
Typical Thermal Resistance (Note 1)	$R_{\theta JL}$ $R_{\theta JA}$	17					75				$^{\circ}\text{C/W}$
Operating Temperature Range	T_j	-65 to +125								$^{\circ}\text{C}$	
Storage Temperature Range	T_{STG}	-65 to +150								$^{\circ}\text{C}$	

Note: 1. Mounted on P.C. Board with 8.0mm² copper pad area.

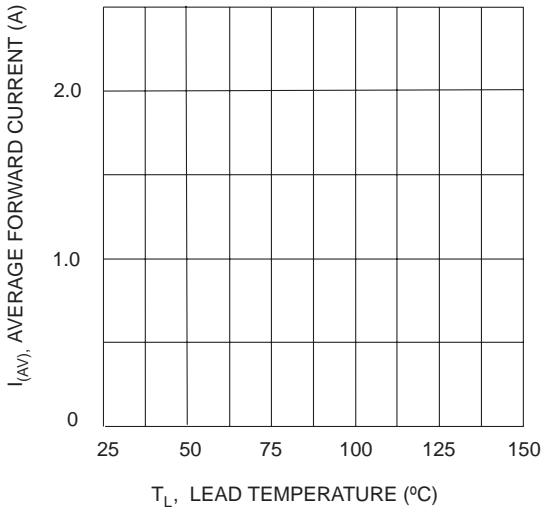

Fig. 1 Forward Current Derating Curve

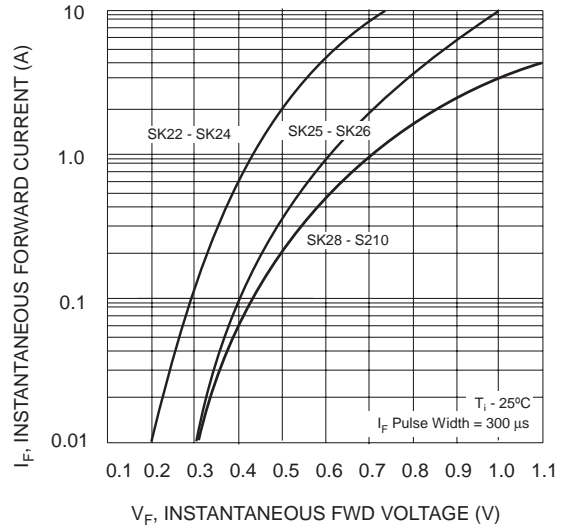

Fig. 2 Typ. Forward Characteristics

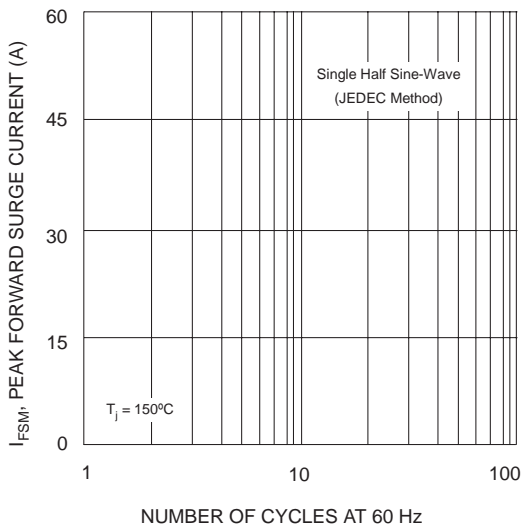

Fig. 3 Max Non-Repetitive Peak Fwd Surge Current

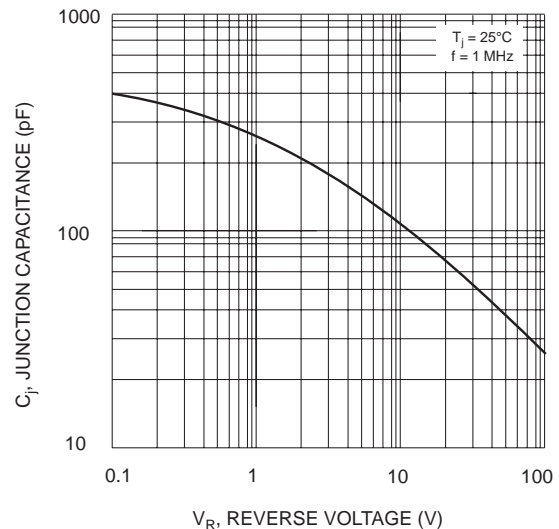

Fig. 4 Typical Junction Capacitance

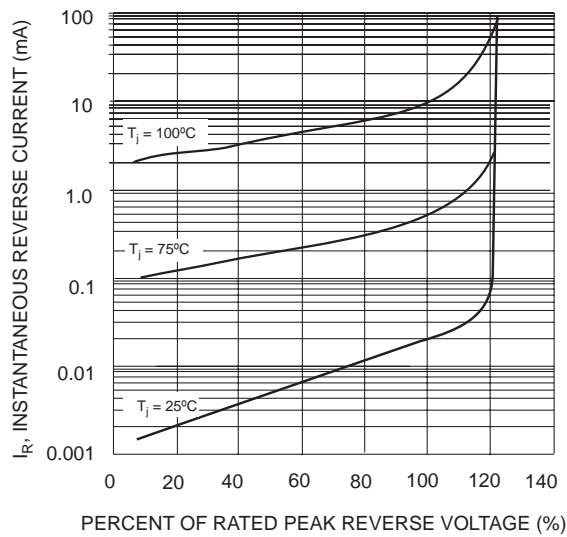

Fig. 5 Typical Reverse Characteristics

MARKING INFORMATION



Cathode = Polarity Band
 WTE = Manufacturer's Logo
 SK2x = Device Number Except S210
 x = 2, 3, 4, 5, 6, 8 or 9

RECOMMENDED FOOTPRINT

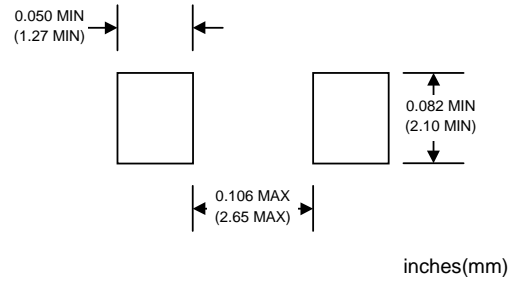

PACKAGING INFORMATION

TAPE & REEL

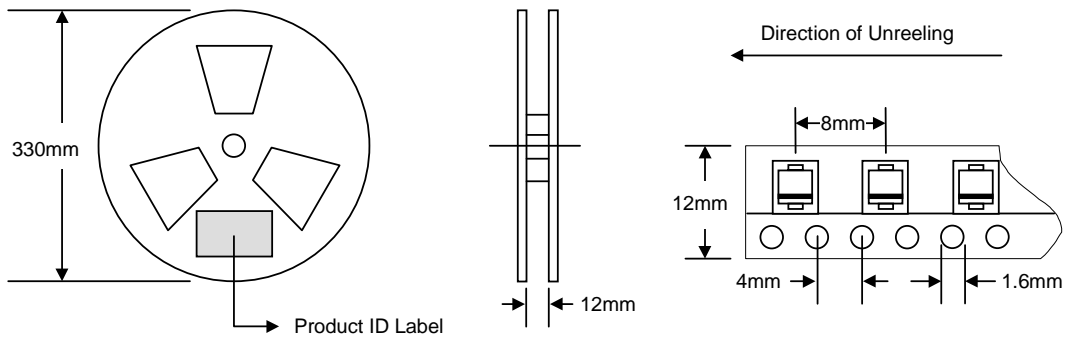

Reel Diameter (mm)	Quantity (PCS)	Inner Box Size L x W x H (mm)	Quantity (PCS)	Carton Size L x W x H (mm)	Quantity (PCS)	Approx. Gross Weight (KG)
330	3,000	340 x 337 x 45	6,000	370 x 370 x 420	48,000	14.0

Note: 1. Paper reel, white or gray color.
 2. Components are packed in accordance with EIA standard 481-1 and 481-2.

ORDERING INFORMATION

Product No.	Package Type	Shipping Quantity
SK22-T3	SMB	3000/Tape & Reel
SK23-T3	SMB	3000/Tape & Reel
SK24-T3	SMB	3000/Tape & Reel
SK25-T3	SMB	3000/Tape & Reel
SK26-T3	SMB	3000/Tape & Reel
SK28-T3	SMB	3000/Tape & Reel
SK29-T3	SMB	3000/Tape & Reel
S210-T3	SMB	3000/Tape & Reel

1. Shipping quantity given is for minimum packing quantity only. For minimum order quantity, please consult the Sales Department.
2. **To order RoHS / Lead Free version (with Lead Free finish), add "-LF" suffix to part number above. For example, SK22-T3-LF.**

Won-Top Electronics Co., Ltd (WTE) has checked all information carefully and believes it to be correct and accurate. However, WTE cannot assume any responsibility for inaccuracies. Furthermore, this information does not give the purchaser of semiconductor devices any license under patent rights to manufacturer. WTE reserves the right to change any or all information herein without further notice.

WARNING: DO NOT USE IN LIFE SUPPORT EQUIPMENT. WTE power semiconductor products are not authorized for use as critical components in life support devices or systems without the express written approval.

Won-Top Electronics Co., Ltd.
No. 44 Yu Kang North 3rd Road, Chine Chen Dist., Kaohsiung, Taiwan
Phone: 886-7-822-5408 or 886-7-822-5410
Fax: 886-7-822-5417
Email: sales@wontop.com
Internet: <http://www.wontop.com>

We power your everyday.