

ORDERING INFORMATION

SS8219GX XX

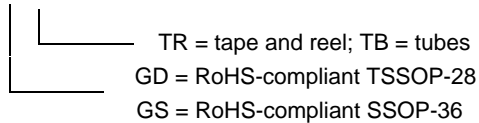

For example: SS8219GD TR
=> SS8219 in RoHS-compliant TSSOP-28
supplied on tape and reel

APPLICATION INFORMATION

Please note for the following sections :

DIFFSENS - refers to the SCSI bus signal.

DIFFSENSE - refers to the SS8219G pin name and internal circuitry related to differential sensing.

DIFFB - refers to the SS8219G pin name and internal circuitry related to monitoring the DIFFSENS line.

The SS8219G is used in multi-mode active-termination applications where single ended (SE) and low voltage differential (LVD) devices might coexist. The LVD termination section consists of 18 source/sink amplifiers (VTOP, VBOT), biasing circuitry and nine precision resistor strings (RTOP, RMID, RBOT). The SE termination section consists of a 2.85V source/sink regulator with nine precision 110Ω resistors. The DIFFSENSE section consists of a 1.3V, 5mA driver and a sensing circuit (Fig.1).

DIFFSENS is used to identify which types of SCSI devices are present on the bus. If the voltage on DIFFSENS is between 0V and 0.5V the bus is single-ended; if it is between 0.7V and 1.9V, the bus is LVD; and if it is greater than 2.4V, the bus is HVD.

The SS8219G DIFFB pin monitors the DIFFSENS line to determine the proper operating mode of the device.

HVD Isolation Mode: The SS8219G identifies that there is an HVD (high voltage differential) device on the SCSI bus and isolates the termination pins from the bus.

When DISCNCT is pulled high, or during thermal shutdown, the termination pins are isolated from the SCSI bus and VREF is grounded. The DIFFSENSE driver is shut down during either of these two events.

To ensure proper operation, the TPWR pin should be connected to the SCSI bus TERMPWR line. As with all analog circuitry, the TERMPWR lines should be bypassed locally. A 2.2μF capacitor and a 0.01μF high frequency capacitor are recommended between TPWR and ground and placed as close as possible to the SS8219G. The IC should be placed as close as possible to the SCSI connector to minimize both signal and power trace length, thereby reducing the input capacitance

and reflections which can degrade the bus signals.

The DIFFSENSE pin can drive the SCSI DIFFSENS line (when M/S is pulled high) to determine the SCSI bus operating mode. The SS8219G switches to the appropriate termination mode for the bus based on the value of the DIFFSENS voltage. These modes are:

LVD mode:

LVD termination is provided by a precision resistor string with two amplifiers. This configuration yields a 105Ω differential and 150Ω common mode impedance. A fail safe bias of 112mV is maintained when no drivers are connected to the SCSI bus.

SE mode:

When the external driver for a given signal line turns off, the active terminator will pull that signal line to 2.85 volts (quiescent state). When used with an active-negation driver, the power amp can sink 22mA per line while keeping the voltage reference in regulation. The terminating resistors maintain their 110 Ω value.

To maintain the specified regulation, a 4.7μF capacitor is required between the VREF pin and ground of each SS8219G. A high frequency capacitor (0.1μF ceramic recommended) can also be placed on the VREF pin in applications that use fast rise/fall time drivers. A typical SCSI bus configuration is shown in Figure 2.

An internal pull-down resistor assures that the SS8219G will still terminate the bus if the DISCNCT pin is left floating.

DIFFSENS noise filtering

The SS8219G incorporates an internal digital filter to remove the noise signal on the DIFFSENS control line, thereby eliminating erroneous switching between modes. An external filter may also be used in addition to this internal digital filter.

BLOCK DIAGRAM (Figure 1)

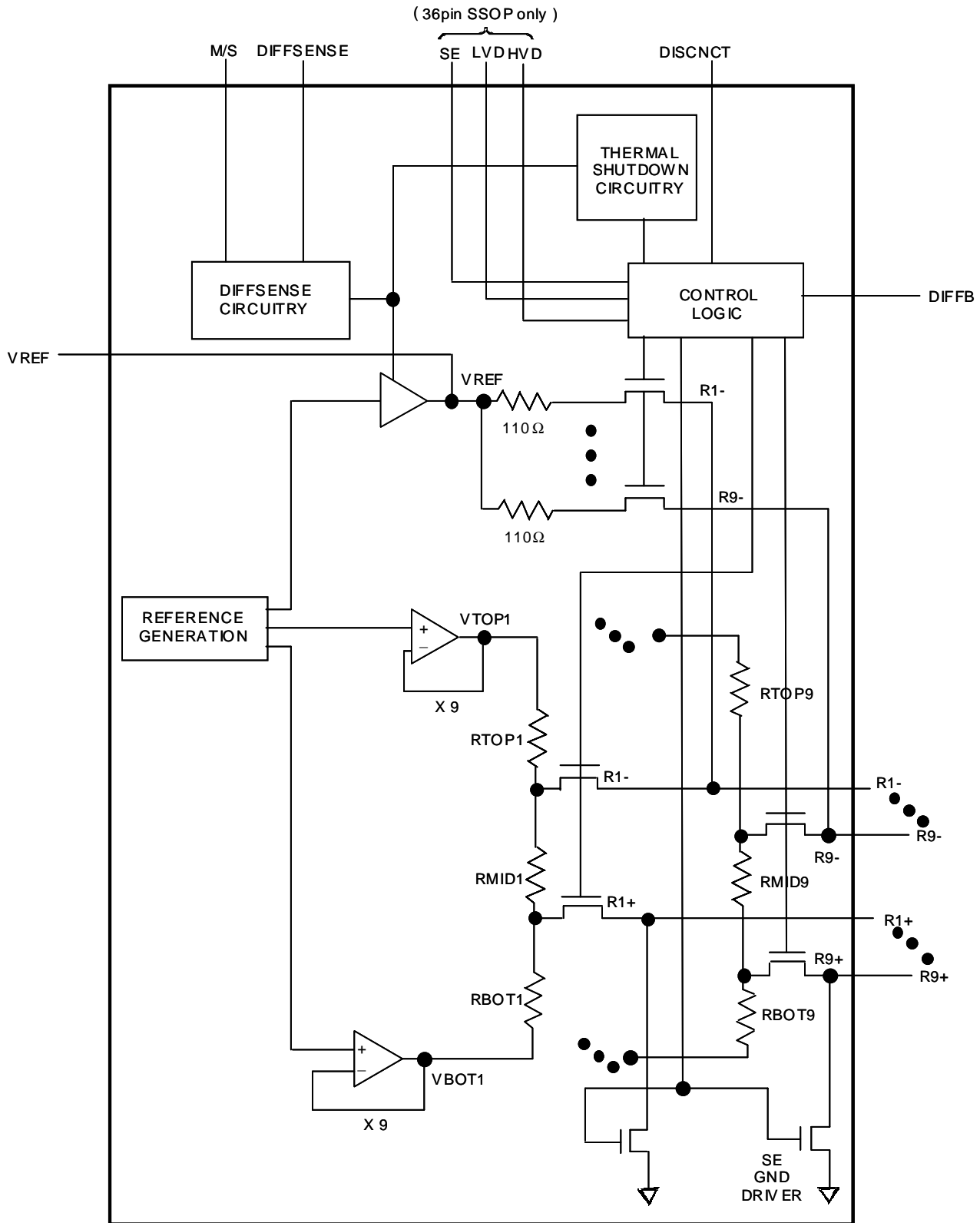

SCSI BUS CONFIGURATION (Figure 2)

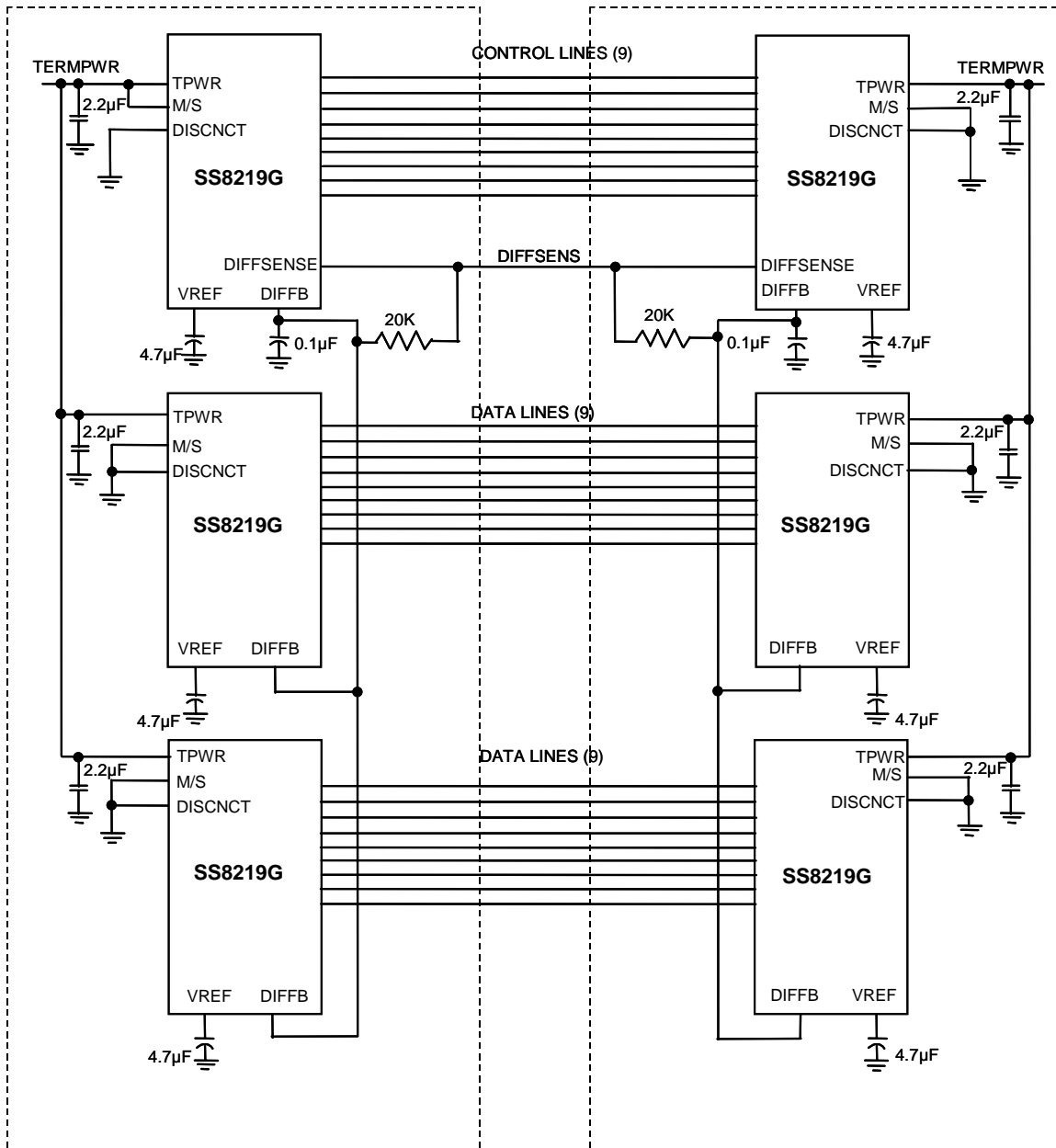

RECOMMENDED OPERATING CONDITIONS

PARAMETER	SYMBOL	MIN	TYP	MAX	UNITS
Termpower Voltage	$V_{tpwr(SE)}$	4.0	5	5.5	V
	$V_{tpwr(LVD)}$	2.9	5	5.5	
Logic 0	V_{il}	-0.3		+0.8	V
Logic 1	V_{ih}	2.0		$V_{tpwr}+0.3$	V
Operating Temperature	T_{amb}	0		70	°C

ELECTRICAL CHARACTERISTICS (from $T_A = 0^\circ\text{C}$ to 70°C , unless otherwise specified)

PARAMETER	SYMBOL	CONDITION	MIN	TYP	MAX	UNITS
LVD Terminator Section						
Differential Mode Termination Resistance	Rdm		100	105	110	Ω
Common Mode Termination Resistance	Rcm		110	150	190	Ω
Differential Mode Bias	Vdm	All lines Open	100	112	125	mV
Common Mode Bias	Vcm		1.125	1.25	1.375	V
Single Ended Terminator Section						
Output Capacitance	Cout	Note			3	pF
SE Termination Resistance	Rse	Vline = 0-3.0 volts	104.5	110	115.5	Ω
SE Voltage Reference	Vref		2.79	2.85	2.93	Volts
SE output Current	Iose	Vline = 0.2 volts			25.4	mA
Regulator Section						
Line Regulation	L _{REG}			1.0	2.5	%
Load Regulation	L _{OREG}			1.3	3.5	%
Current Limit	I _{LIM}			350		mA
Sink Current	I _{SINK}		200			mA
DC Section						
Termpower Current	I _{tpmr}	SE mode (No Load)		4		mA
		LVD mode (No Load)		20		
Input Leakage High	I _{ih}		-1.0			μA
Input Leakage Low	I _{il}				1.0	μA
Output Current High	I _{oh}	V _{out} = 2.4 volts; SE/LVD/HVD Pins only	-1.0			mA
Output Current Low	I _{ol}	V _{out} =0.4 volts; SE/LVD/HVD Pins only	4.0			mA
DIFFSENS Section						
DIFFSENS SE Operating Range	V _{seor}		-0.3		0.5	V
DIFFSENS LVD Operating Range	V _{lvdor}		0.7		1.9	V
DIFFSENS HVD Operating Range	V _{hvdor}		2.4		$V_{tpwr}+0.3$	V
DIFFSENSE Driver Output Voltage	V _{dso}	M/S=1; I _{ds} = 0-5mA	1.2		1.4	V
DIFFSENSE Driver Source Current	I _{dsh}	M/S = 1; V _{dso} =0V		5	15	mA
DIFFSENSE Driver Sink Current	I _{dsl}	M/S=1; V _{dso} =2.75V	20		200	μA

Note: guaranteed by Design.

Common Mode Bias Vcm vs. Vtpwr

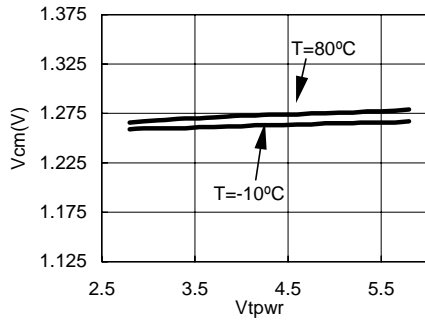

Common Mode Bias Vcm vs. Temperature

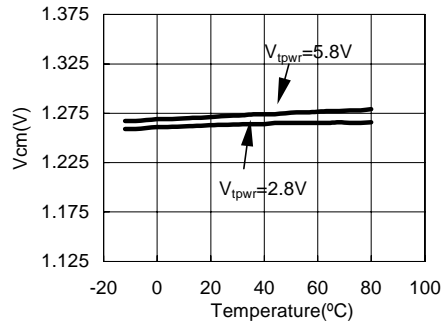

Differential Mode Bias Vdm vs. Vtpwr

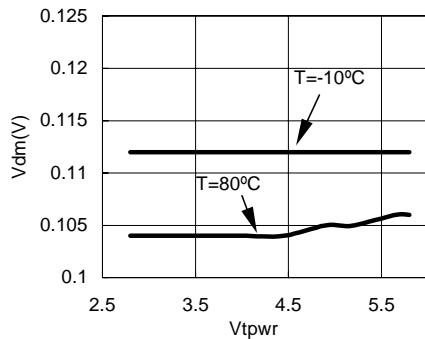

Differential Mode Bias Vdm vs. Temperature@Vtpwr=5V

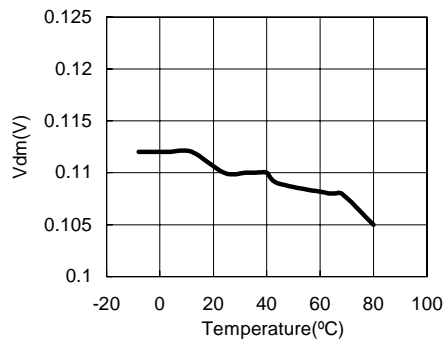

Common Mode Termination Resistance Rcm vs. Vtpwr at Temperature=24°C

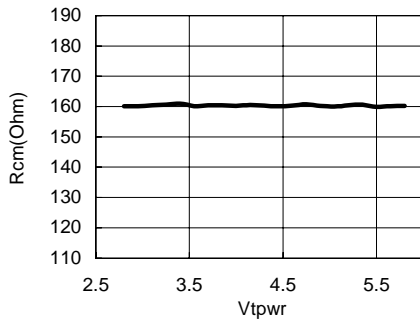

Common Mode Termination Resistance Rcm vs. Temperature at Vtpwr=5V

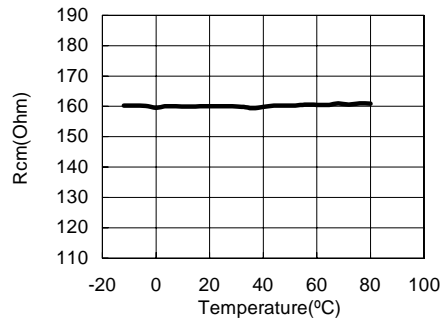

Differential Mode Termination Resistance Rdm vs. Vtpwr

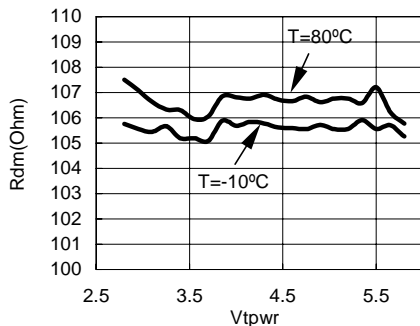

Differential Mode Termination Resistance Rdm vs. Temperature

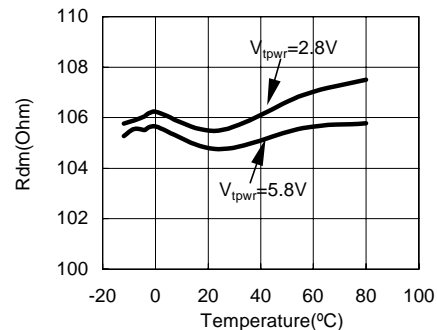

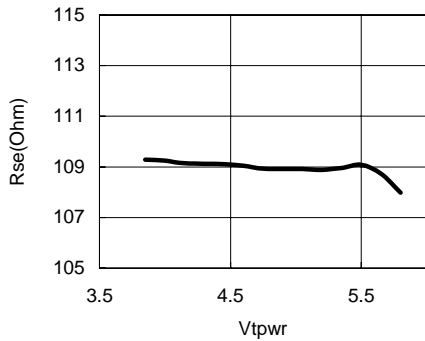
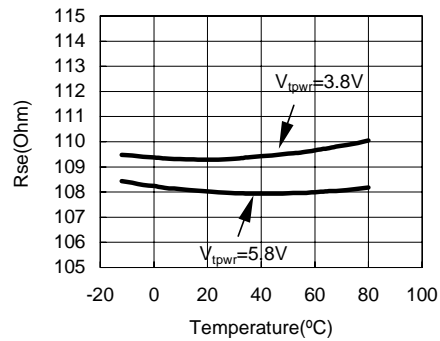
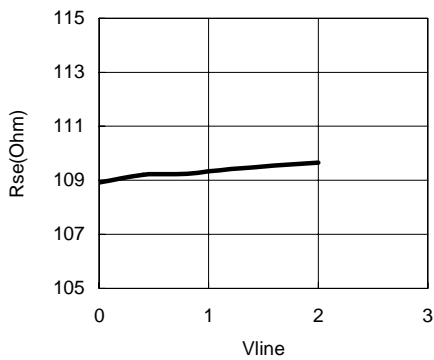
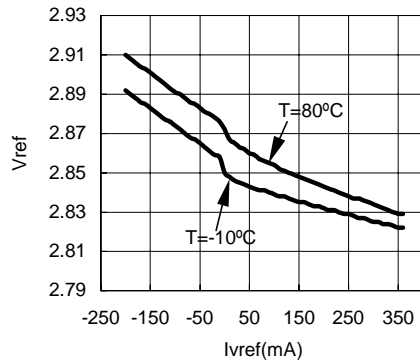
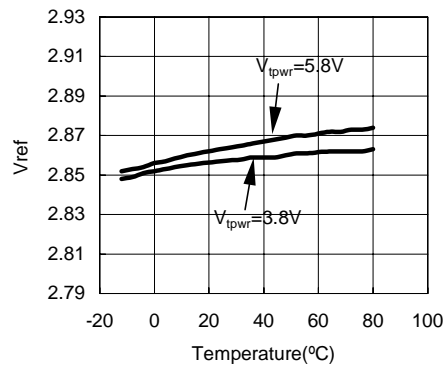
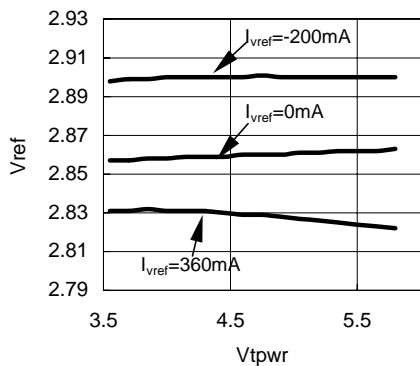
SE Termination Resistance Rse vs. Vtpwr at T=24°C; Vline=0V

SE Termination Resistance Rse vs. Vtpwr at Vline=0V

SE Termination Resistance Rse vs. Vtpwr at Vtpwr=5V; T=24°C

Vref vs. Ivref at Vtpwr=5V

Vref vs. Temperature at Ivref=0mA

Vref vs. Vtpwr at T=24°C

PIN DESCRIPTION (for 28pin TSSOP)

PIN	SYMBOL	DESCRIPTION
1	VREF	Reference Voltage. 2.85-volt reference in SE mode and 1.25V in LVD mode; must be connected to a 4.7 μ F capacitor.
2-5,7-12, 18-21, 23-26	Rx+, Rx-	Signal Termination. (X=1,2,3,.....9) Rx+: Ground line for single-ended or positive line for differential applications for the SCSI bus. Rx-: Signal line/active line for single-ended or negative line in differential applications for the SCSI bus.
6,22	NC/ HS GND	No Connect/Heat Sink Ground. Should be grounded for heat sinking purpose
13	DISCNET	Disconnect. When pulled high, the SS8219G isolates its bus pins (Rx+, Rx-) from the SCSI bus.
14	GND	Ground. Terminator ground pin. Connected to ground.
15	M/S	Master/slave. Used to select which terminator is the controlling device. M/S pin high enables the DIFFSENSE driver.
16	DIFFSENSE	Output to drive the SCSI bus DIFFSENS line.
17	DIFFB	An input pin to detect the type of device (differential or single-ended) on the SCSI bus. The DIFFB pin should be connected by a 0.1 μ F capacitor to GND and by a 20k Ω resistor to the SCSI bus DIFFSENS line.
27,28	TPWR	Terminator Power. Connect to the SCSI TERMPWR line and de-couple with a 2.2 μ F capacitor.

*The VREF keeps the level at 2.85 volts, whether the DISCNET pin is asserted or not; even if the termination mode is changed.

PIN DESCRIPTION (for 36pin SSOP)

PIN	SYMBOL	DESCRIPTION
1	VREF*	Reference Voltage. 2.85-volt reference; must be connected to a 4.7 μ F capacitor.
2,3	NC	No Connect. Do not connect these pins.
4-7,11-16, 22-25, 29-32	Rx+ Rx-	Signal Termination. (X=1,2,3,.....9) Rx+: Ground line for single-ended or positive line for differential applications for the SCSI bus. Rx-: Signal line/active line for single-ended or negative line in differential applications for the SCSI bus.
8, 9,10,26, 27,28	HS/GND	Heat Sink Ground. Connect to large area PC board traces to increase power dissipation capability.
17	DISCNET	Disconnect. When pulled high, the SS8219G isolates its bus pins (Rx+, Rx-) from the SCSI bus.
18	GND	Ground. Terminator ground pin. Connected to ground.
19	M/S	Master/slave. Used to select which terminator is the controlling device. M/S pin high enables the DIFFSENSE driver.
20	DIFFSENSE	Output to drive the SCSI bus DIFFSENS line.
21	DIFFB	An input pin to detect the type of device (differential or single-ended) on the SCSI bus. The DIFFB pin should be connected by a 0.1 μ F capacitor to GND and 20k Ω resistor to the SCSI bus DIFFSENS line.
33	SE	Single ended mode indicator. It is HIGH when terminator is operating in SE mode.
34	LVD	Low Voltage Differential mode indicator. It is HIGH when terminator is operating in LVD mode.
35	HVD	High Voltage Differential mode indicator. It is HIGH when terminator is operating in HVD mode
36	TPWR	Terminator Power. Connect to SCSI bus TERMPWR line and decouple with 2.2 μ F capacitor.

*The VREF keeps the level at 2.85 volts, whether the DISCNET pin is asserted or not; even if the termination mode is changed.

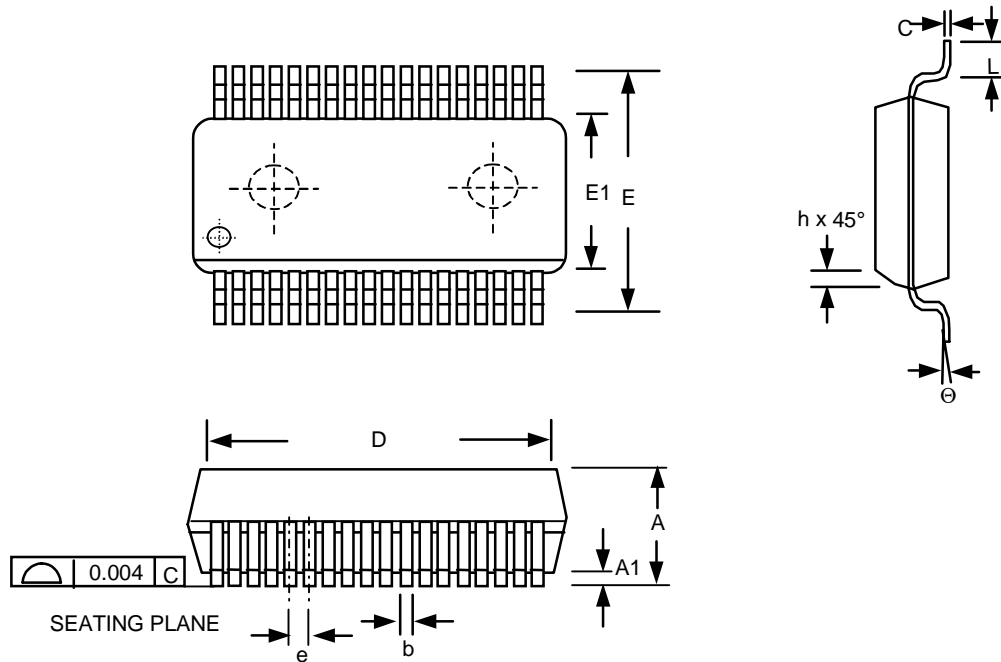
PHYSICAL DIMENSIONS (36pin SSOP - order package option S)

SYMBOL	DIMENSION IN MM			DIMENSION IN INCH		
	MIN.	TYP.	MAX.	MIN.	TYP.	MAX.
A	2.413	2.591	2.794	0.095	0.102	0.110
A1	0.203	0.305	0.406	0.008	0.012	0.016
b	0.300		0.450			0.018
c	0.127		0.254	0.005		0.010
D	15.748	15.875	16.002	0.620	0.625	0.630
e	0.800 BASIC			0.032 BASIC		
E	10.033		10.668	0.395		0.420
E1	7.391	7.493	7.595	0.291	0.295	0.289
h	0.381		0.635	0.015		0.025
L	0.508		1.016	0.020		0.040
Θ	0°		8°	0°		8°

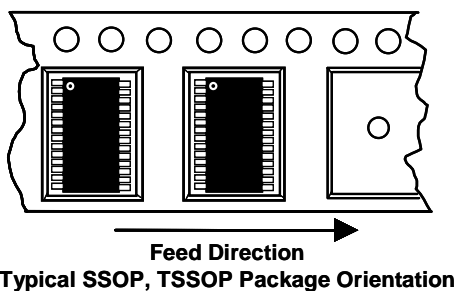
Taping Specification

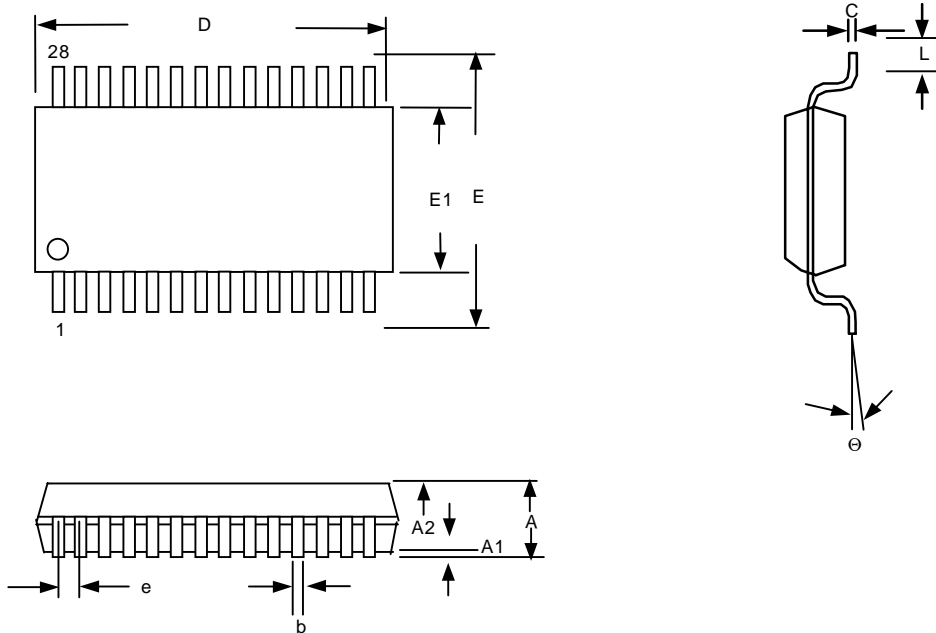
PHYSICAL DIMENSIONS (28pin TSSOP - order package option D)

Note:

1. Package body dimensions exclude mold flash protrusions or gate burrs
2. Tolerance $\pm 0.1\text{mm}$ unless otherwise specified
3. Coplanarity : 0.1mm
4. Controlling dimensions are in millimeters. Converted inch dimensions are not necessarily accurate.
5. Follows JEDEC MO-153

SYMBOL	DIMENSION IN MM			DIMENSION IN INCH		
	MIN.	NOM.	MAX.	MIN.	NOM.	MAX.
A	----	----	1.20	----	----	0.048
A1	0.05	----	0.15	0.002	----	0.006
A2	0.80	1.00	1.05	0.031	0.039	0.041
b	0.19	----	0.30	0.007	----	0.012
C	0.09	----	0.20	0.004	----	0.008
D	9.60	9.70	9.80	0.378	0.382	0.386
E	----	6.40	----	----	0.252	----
E1	4.30	4.40	4.50	0.169	0.173	0.177
e	----	0.65	----	----	0.026	----
L	0.45	0.60	0.75	0.018	0.024	0.030
y	----	----	0.10	----	----	0.004
θ	0°	----	8°	0°	----	8°

Information furnished by Silicon Standard Corporation is believed to be accurate and reliable. However, Silicon Standard Corporation makes no guarantee or warranty, express or implied, as to the reliability, accuracy, timeliness or completeness of such information and assumes no responsibility for its use, or for infringement of any patent or other intellectual property rights of third parties that may result from its use. Silicon Standard reserves the right to make changes as it deems necessary to any products described herein for any reason, including without limitation enhancement in reliability, functionality or design. No license is granted, whether expressly or by implication, in relation to the use of any products described herein or to the use of any information provided herein, under any patent or other intellectual property rights of Silicon Standard Corporation or any third parties.