



# TISP4070L3AJ THRU TISP4395L3AJ

## BIDIRECTIONAL THYRISTOR OVERVOLTAGE PROTECTORS

### TISP4xxxL3AJ Overvoltage Protector Series

**SMA (DO-214AC) Package**  
25% Smaller Placement Area than SMB

**Ion-Implanted Breakdown Region**  
Precise and Stable Voltage

Device	V <sub>DRM</sub> V	V <sub>(BO)</sub> V
'4070	58	70
'4080	65	80
'4090	70	90
'4125	100	125
'4145	120	145
'4165	135	165
'4180	145	180
'4220	160	220
'4240	180	240
'4260	200	260
'4290	230	290
'4320	240	320
'4350	275	350
'4360	290	360
'4395	320	395

#### SMAJ Package (Top View)

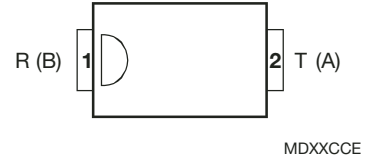

#### Device Symbol



Terminals T and R correspond to the alternative line designators of A and B

 ..... UL Recognized Components

#### Rated for International Surge Wave Shapes

Wave Shape	Standard	I <sub>TSP</sub> A
2/10 μs	GR-1089-CORE	125
8/20 μs	IEC 61000-4-5	100
10/160 μs	FCC Part 68	65
10/700 μs	ITU-T K.20/21/45	50
10/560 μs	FCC Part 68	40
10/1000 μs	GR-1089-CORE	30

#### How To Order

Device	Package	Carrier	For Standard Termination Finish Order As	For Lead Free Termination Finish Order As
TISP4xxxL3AJ	SMA (DO-214AC)	Embossed Tape Reel Pack	TISP4xxxL3AJR	TISP4xxxL3AJR-S

Insert xxx value corresponding to protection voltages of 070, 080, 090, etc.

\*RoHS Directive 2002/95/EC Jan 27 2003 including Annex JULY 2000 - REVISED FEBRUARY 2005  
Specifications are subject to change without notice.  
Customers should verify actual device performance in their specific applications.

# TISP4xxxL3AJ Overvoltage Protector Series

**BOURNS®**

## Description

These devices are designed to limit overvoltages on the telephone line. Overvoltages are normally caused by a.c. power system or lightning flash disturbances which are induced or conducted on to the telephone line. A single device provides 2-point protection and is typically used for the protection of 2-wire telecommunication equipment (e.g. between the Ring and Tip wires for telephones and modems). Combinations of devices can be used for multi-point protection (e.g. 3-point protection between Ring, Tip and Ground).

The protector consists of a symmetrical voltage-triggered bidirectional thyristor. Overvoltages are initially clipped by breakdown clamping until the voltage rises to the breakover level, which causes the device to crowbar into a low-voltage on state. This low-voltage on state causes the current resulting from the overvoltage to be safely diverted through the device. The high crowbar holding current prevents d.c. latchup as the diverted current subsides.

The TISP4xxxL3 range consists of fifteen voltage variants to meet various maximum system voltage levels (58 V to 320 V). They are guaranteed to voltage limit and withstand the listed international lightning surges in both polarities. These protection devices are in an SMAJ (JEDEC DO-214AC with J-bend leads) plastic package. These devices are supplied in embossed tape reel carrier pack. For alternative voltage and holding current values, consult the factory. For higher rated impulse currents, the 50 A 10/1000 TISP4xxxM3AJ series in SMA and the 100 A 10/1000 TISP4xxxH3BJ series in SMB are available.

## Absolute Maximum Ratings, $T_A = 25\text{ }^\circ\text{C}$ (Unless Otherwise Noted)

Rating	Symbol	Value	Unit
Repetitive peak off-state voltage, (see Note 1)	'4070	$\pm 58$	V
	'4080	$\pm 65$	
	'4090	$\pm 70$	
	'4125	$\pm 100$	
	'4145	$\pm 120$	
	'4165	$\pm 135$	
	'4180	$\pm 145$	
	'4220	$\pm 160$	
	'4240	$\pm 180$	
	'4260	$\pm 200$	
	'4290	$\pm 230$	
	'4320	$\pm 240$	
	'4350	$\pm 275$	
	'4360	$\pm 290$	
	'4395	$\pm 320$	
Non-repetitive peak on-state pulse current (see Notes 2, 3 and 4)	$I_{TSP}$	125	A
2/10 $\mu\text{s}$ (GR-1089-CORE, 2/10 $\mu\text{s}$ voltage wave shape)		100	
8/20 $\mu\text{s}$ (IEC 61000-4-5, combination wave generator, 1.2/50 voltage, 8/20 current)		65	
10/160 $\mu\text{s}$ (FCC Part 68, 10/160 $\mu\text{s}$ voltage wave shape)		50	
5/310 $\mu\text{s}$ (ITU-T K.20/21/45, K.44 10/700 $\mu\text{s}$ voltage wave shape)		50	
5/310 $\mu\text{s}$ (FTZ R12, 10/700 $\mu\text{s}$ voltage wave shape)		40	
10/560 $\mu\text{s}$ (FCC Part 68, 10/560 $\mu\text{s}$ voltage wave shape)		30	
10/1000 $\mu\text{s}$ (GR-1089-CORE, 10/1000 $\mu\text{s}$ voltage wave shape)			
Non-repetitive peak on-state current (see Notes 2, 3 and 4)	$I_{TSM}$	18	A
20 ms (50 Hz) full sine wave		7	
1 s (50 Hz) full sine wave		1.6	
1000 s 50 Hz/60 Hz a.c.			
Junction temperature	$T_J$	-40 to +150	$^\circ\text{C}$
Storage temperature range	$T_{stg}$	-65 to +150	$^\circ\text{C}$

- NOTES: 1. For voltage values at lower temperatures, derate at 0.13 %/ $^\circ\text{C}$ .  
 2. Initially, the TISP4xxxL3 must be in thermal equilibrium with  $T_J = 25\text{ }^\circ\text{C}$ .  
 3. The surge may be repeated after the TISP4xxxL3 returns to its initial conditions.  
 4. EIA/JESD51-2 environment and EIA/JESD51-3 PCB with standard footprint dimensions connected with 5 A rated printed wiring track widths. Derate current values at -0.61 %/ $^\circ\text{C}$  for ambient temperatures above  $25\text{ }^\circ\text{C}$ .

JULY 2000 - REVISED FEBRUARY 2005  
 Specifications are subject to change without notice.  
 Customers should verify actual device performance in their specific applications.

# TISP4xxxL3AJ Overvoltage Protector Series

**BOURNS®**

## Recommended Operating Conditions

Component		Min	Typ	Max	Unit
R <sub>S</sub>	series resistor for FCC Part 68, 10/560 type A surge survival	12			Ω
	series resistor for FCC Part 68, 9/720 type B surge survival	0			Ω
	series resistor for GR-1089-CORE first-level and second-level surge survival	23			Ω
	series resistor for K.20, K.21 and K.45 1.5 kV, 10/700 surge survival	0			Ω
	series resistor for K.20, K.21 and K.45 coordination with a 400 V primary protector	7			Ω

## Electrical Characteristics, T<sub>A</sub> = 25 °C (Unless Otherwise Noted)

Parameter	Test Conditions	Min	Typ	Max	Unit
I <sub>DRM</sub> Repetitive peak off-state current	V <sub>D</sub> = V <sub>DRM</sub> T <sub>A</sub> = 25 °C T <sub>A</sub> = 85 °C			±5 ±10	μA
V <sub>(BO)</sub> Breakover voltage	dv/dt = ±250 V/ms, R <sub>SOURCE</sub> = 300 Ω			±70 ±80 ±90 ±125 ±145 ±165 ±180 ±220 ±240 ±260 ±290 ±320 ±350 ±360 ±395	V
I <sub>(BO)</sub> Breakover current	dv/dt = ±250 V/ms, R <sub>SOURCE</sub> = 300 Ω			±0.8	A
I <sub>H</sub> Holding current	I <sub>T</sub> = ±5 A, di/dt = +/-30 mA/ms	±0.15		±0.60	A
dv/dt Critical rate of rise of off-state voltage	Linear voltage ramp, Maximum ramp value < 0.85V <sub>DRM</sub>	±5			kV/μs
I <sub>D</sub> Off-state current	'4070, V <sub>D</sub> = ±52 V '4080, V <sub>D</sub> = ±59 V '4090, V <sub>D</sub> = ±63 V '4125, V <sub>D</sub> = ±90 V '4145, V <sub>D</sub> = ±108 V '4165, V <sub>D</sub> = ±122 V '4180, V <sub>D</sub> = ±131 V '4220, V <sub>D</sub> = ±144 V '4240, V <sub>D</sub> = ±162 V '4260, V <sub>D</sub> = ±180 V '4290, V <sub>D</sub> = ±207 V '4320, V <sub>D</sub> = ±216 V '4350, V <sub>D</sub> = ±248 V '4360, V <sub>D</sub> = ±261 V '4395, V <sub>D</sub> = ±288 V			±2	μA
I <sub>D</sub> Off-state current	V <sub>D</sub> = ±50 V			±10	μA

JULY 2000 - REVISED FEBRUARY 2005

Specifications are subject to change without notice.

Customers should verify actual device performance in their specific applications.

# TISP4xxxL3AJ Overvoltage Protector Series

**BOURNS®**

## Electrical Characteristics, $T_A = 25\text{ °C}$ (Unless Otherwise Noted) (Continued)

Parameter	Test Conditions	Min	Typ	Max	Unit
$C_{off}$ Off-state capacitance	$f = 1\text{ MHz}, V_d = 1\text{ V rms}, V_D = \pm 1\text{ V}$	4070 thru '4090	53	64	pF
		'4125 thru '4220	40	48	
		'4240 thru '4395	33	40	
	$f = 1\text{ MHz}, V_d = 1\text{ V rms}, V_D = \pm 50\text{ V}$	'4070 thru '4090	25	30	
		'4125 thru '4220	18	22	
		'4240 thru '4395	14	17	

## Thermal Characteristics

Parameter	Test Conditions	Min	Typ	Max	Unit
$R_{\theta JA}$ Junction to free air thermal resistance	EIA/JESD51-3 PCB, $I_T = I_{TSM(1000)}$ , $T_A = 25\text{ °C}$ , (see Note 75)			115	°C/W
	265 mm x 210 mm populated line card, 4-layer PCB, $I_T = I_{TSM(1000)}$ , $T_A = 25\text{ °C}$		52		

NOTE 5: EIA/JESD51-2 environment and PCB has standard footprint dimensions connected with 5 A rated printed wiring track widths.

## Parameter Measurement Information

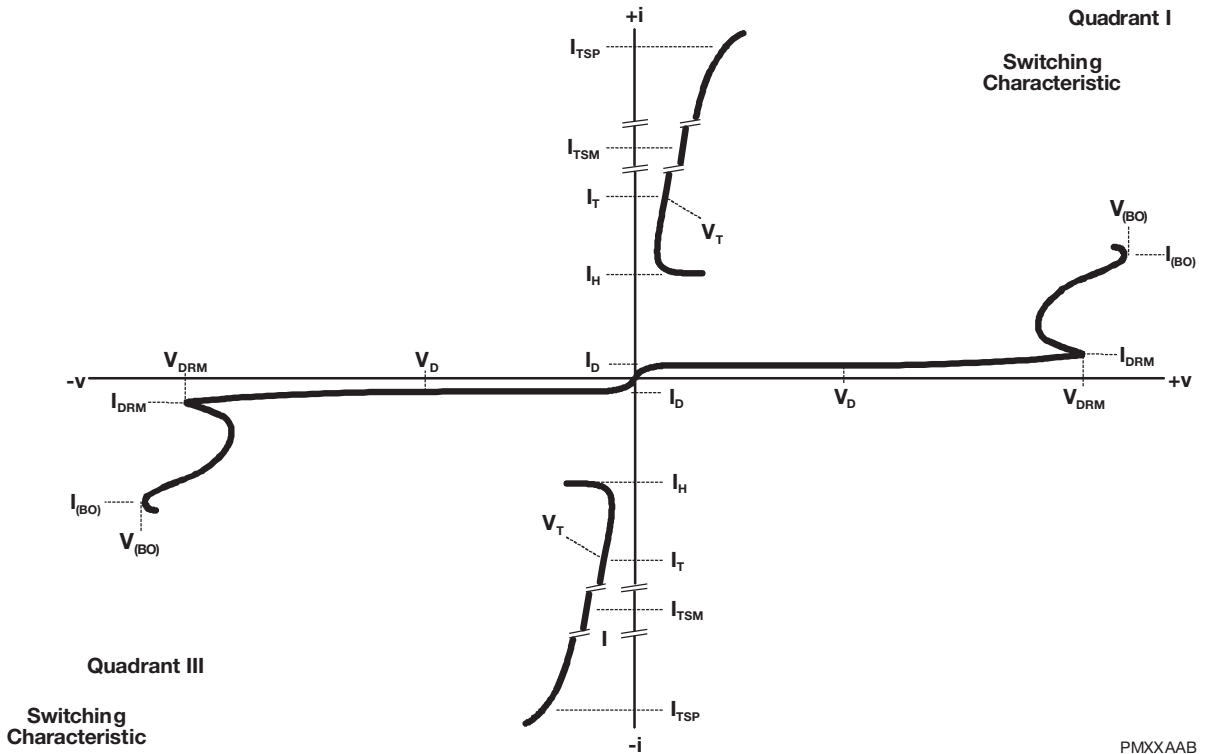

Figure 1. Voltage-Current Characteristic for T and R Terminals  
All Measurements are Referenced to the R Terminal

PMXXAAB

## Typical Characteristics

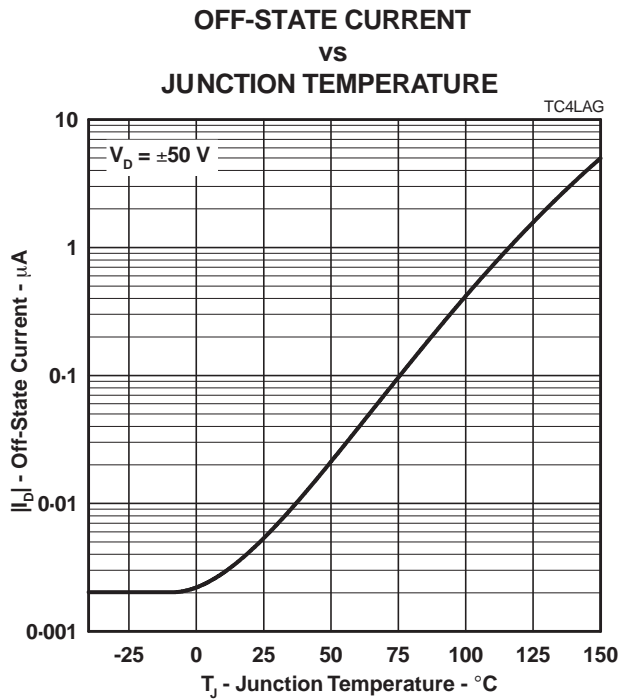

Figure 2.

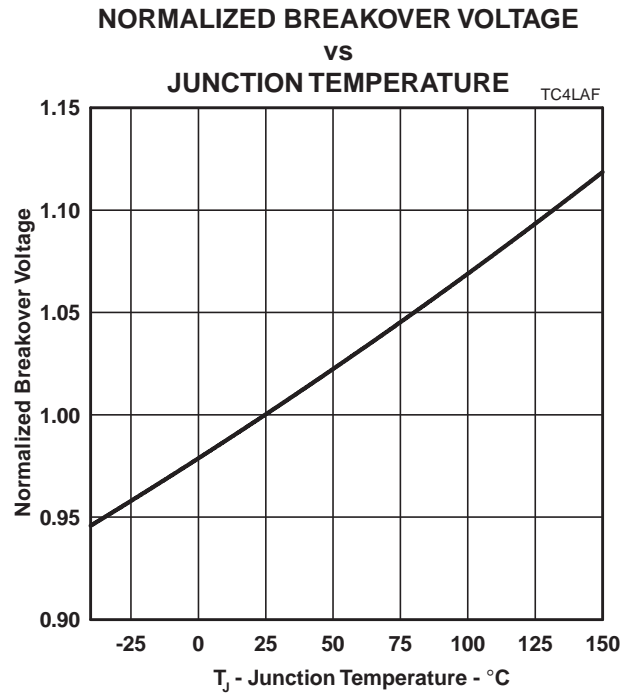

Figure 3.

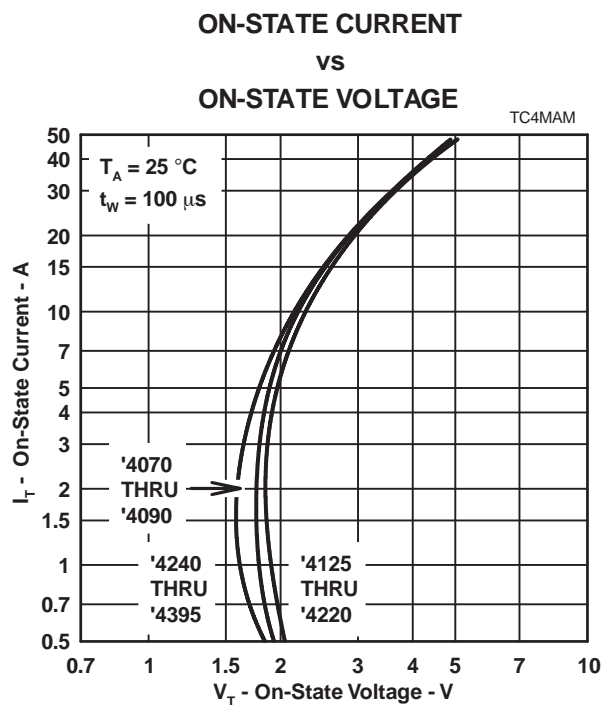

Figure 4.

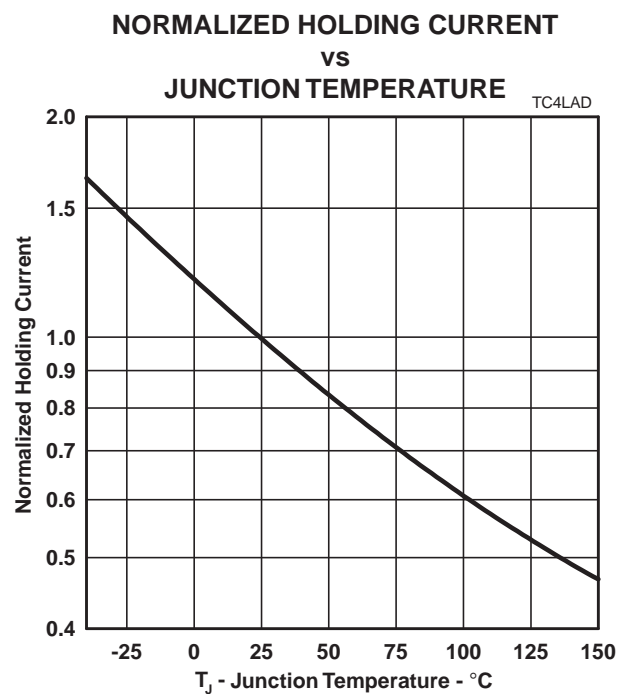
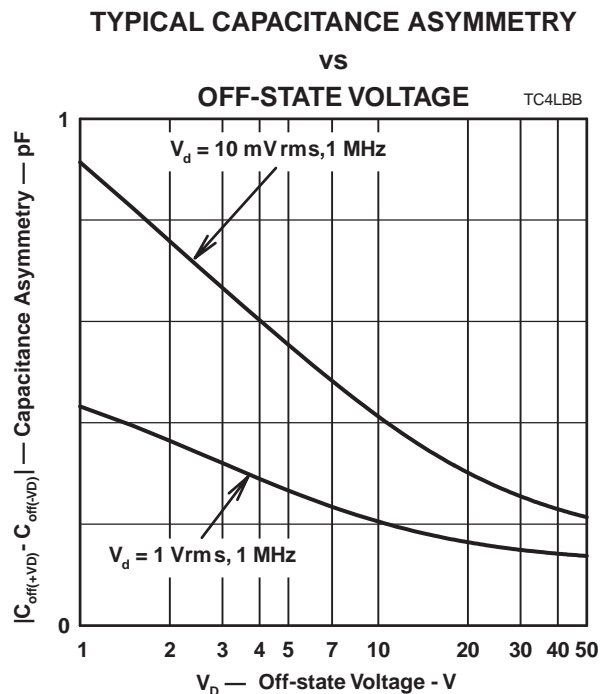
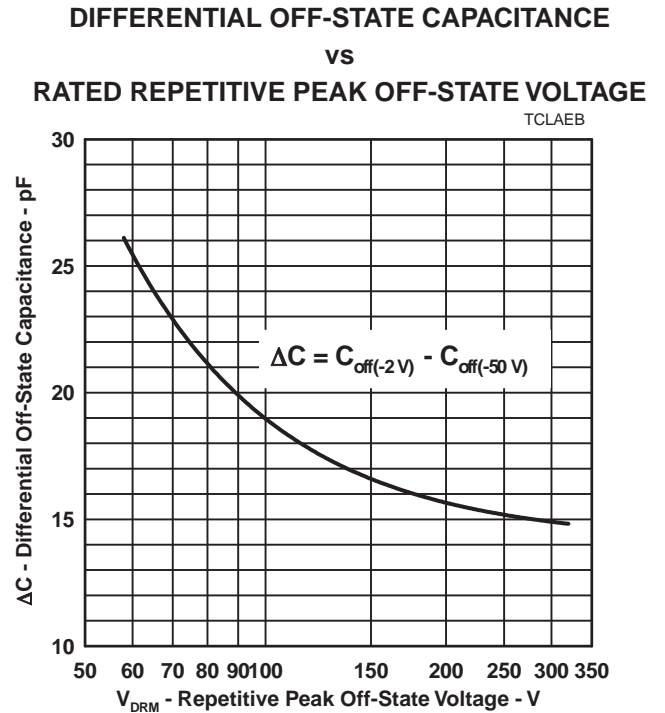
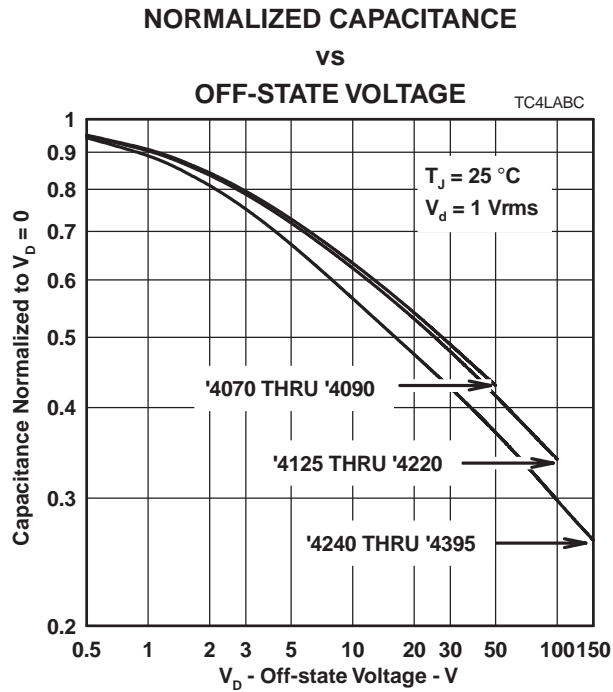

Figure 5.

## Typical Characteristics



JULY 2000 - REVISED FEBRUARY 2005  
 Specifications are subject to change without notice.  
 Customers should verify actual device performance in their specific applications.

## Rating and Thermal Information

### NON-REPETITIVE PEAK ON-STATE CURRENT VS CURRENT DURATION

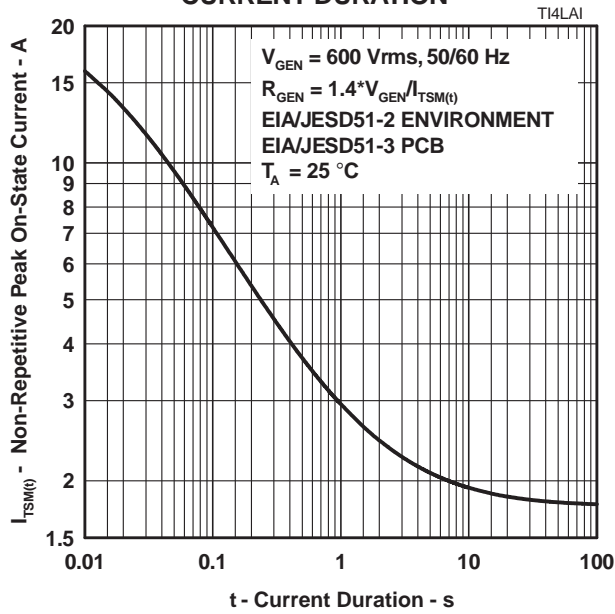

Figure 9.

### V\_DRM DERATING FACTOR VS MINIMUM AMBIENT TEMPERATURE

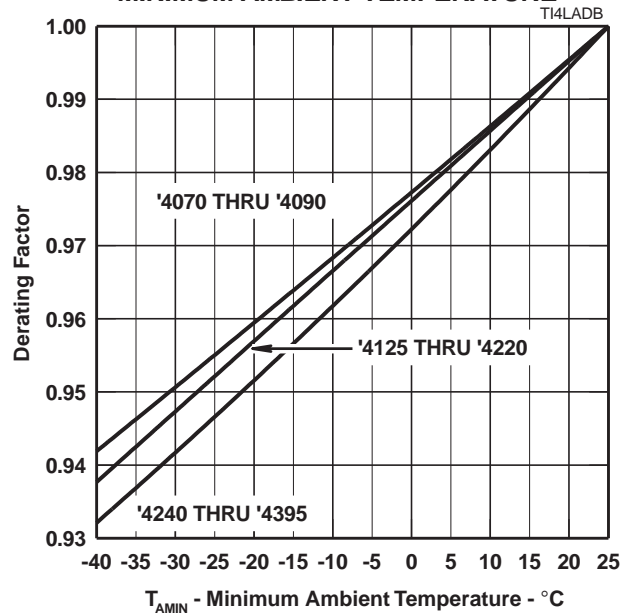
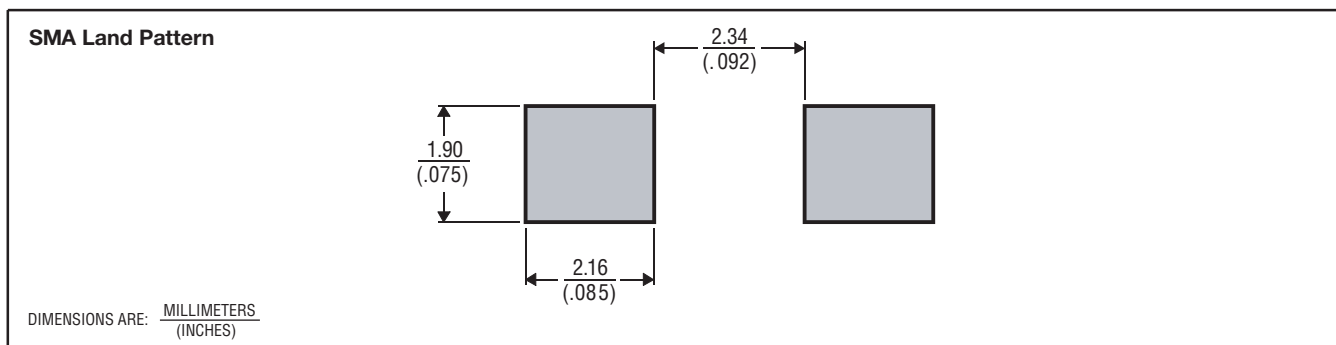

Figure 10.



## MECHANICAL DATA

### Recommended Printed Wiring Land Pattern Dimensions



MDXX BIC

### Device Symbolization Code

Devices will be coded as below. As the device parameters are symmetrical, terminal 1 is not identified.

Device	Symbolization Code
TISP4070L3	4070L
TISP4080L3	4080L
TISP4090L3	4090L
TISP4125L3	4125L
TISP4145L3	4145L
TISP4165L3	4165L
TISP4180L3	4180L
TISP4220L3	4220L
TISP4240L3	4240L
TISP4260L3	4260L
TISP4290L3	4290L
TISP4320L3	4320L
TISP4350L3	4350L
TISP4360L3	4360L
TISP4395L3	4395L

### Carrier Information

For production quantities, the carrier will be embossed tape reel pack. Evaluation quantities may be shipped in bulk pack or embossed tape.

Carrier	Standard Quantity
Embossed Tape Reel Pack	5,000

# TISP4xxxL3AJ Overvoltage Protector Series

**BOURNS®**

## MECHANICAL DATA

### SMAJ (DO-214AC) Plastic Surface Mount Diode Package

This surface mount package consists of a circuit mounted on a lead frame and encapsulated within a plastic compound. The compound will withstand soldering temperature with no deformation, and circuit performance characteristics will remain stable when operated in high humidity conditions. Leads require no additional cleaning or processing when used in soldered assembly.

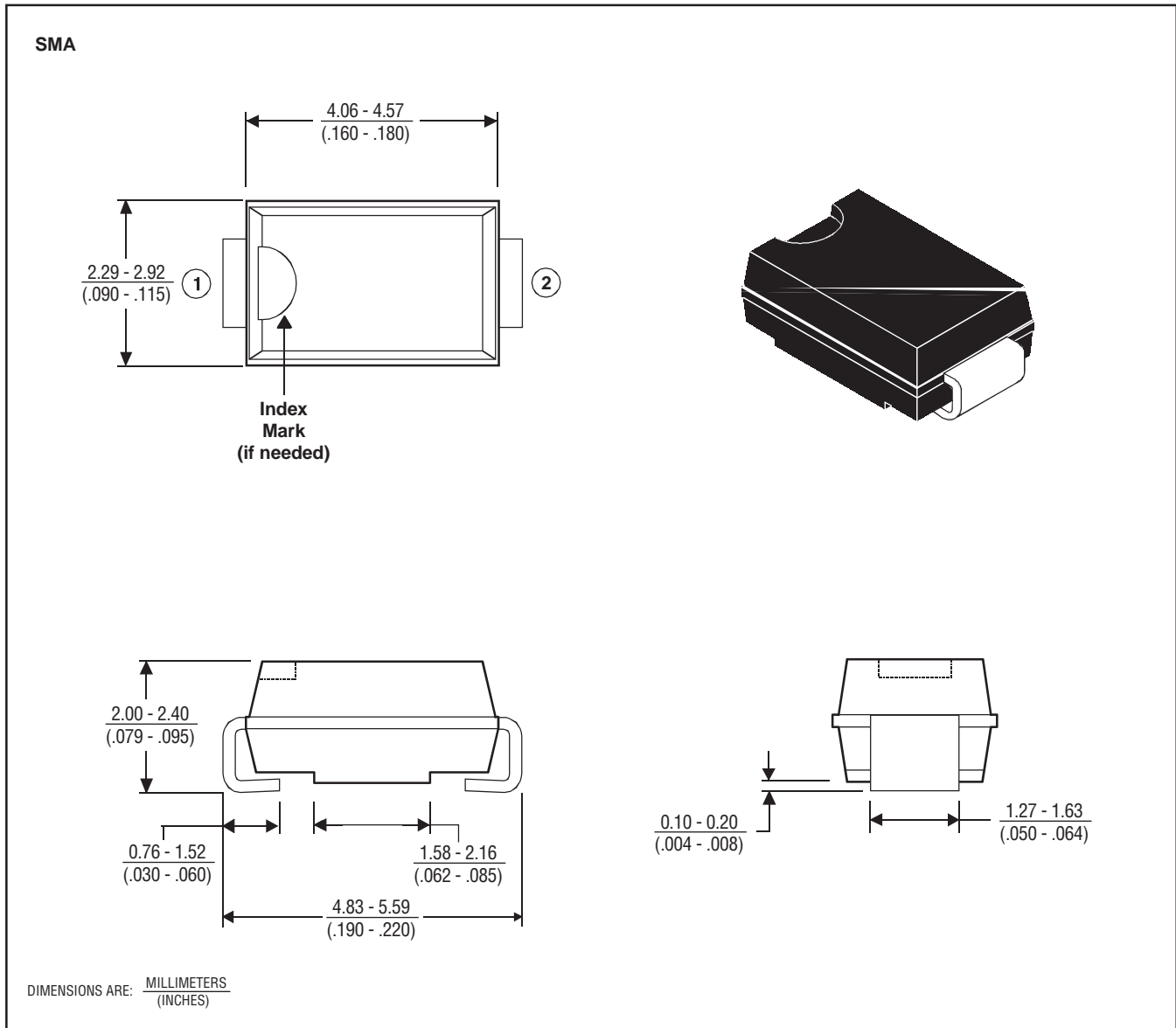

MDXXCAA

JULY 2000 - REVISED FEBRUARY 2005  
Specifications are subject to change without notice.  
Customers should verify actual device performance in their specific applications.

# TISP4xxxL3AJ Overvoltage Protector Series

**BOURNS®**

## MECHANICAL DATA

### Tape Dimensions

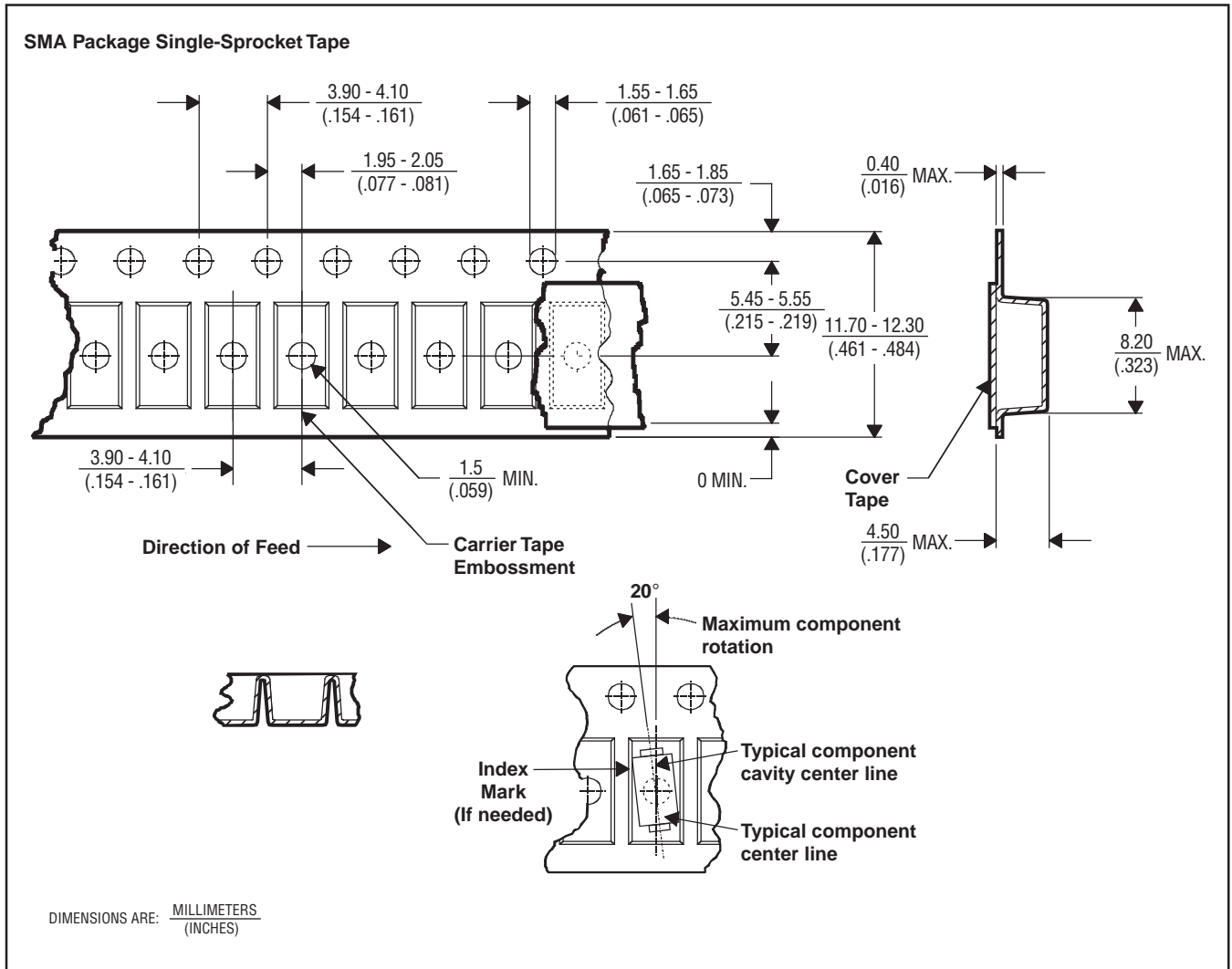

NOTES: A. The clearance between the component and the cavity must be within 0.05 mm (.002 in) MIN. to 0.65 mm (.026 in) MAX. so that the component cannot rotate more than  $20^\circ$  within the determined cavity. MDXXCGA

B. Taped devices are supplied on a reel of the following dimensions:

Reel diameter: 330 mm  $\pm$  3.0 mm (12.99 in  $\pm$  .12 in)  
 Reel hub diameter: 75 mm (2.95 in) MIN.  
 Reel axial hole: 13.0 mm  $\pm$  0.5 mm (.51 in  $\pm$  .02 in)

C. 5000 devices per reel.

JULY 2000 - REVISED FEBRUARY 2005

Specifications are subject to change without notice.

Customers should verify actual device performance in their specific applications.

"TISP" is a trademark of Bourns, Ltd., a Bourns Company and Registered in U.S. Patent and Trademark Office.

"Bourns" is a registered trademark of Bourns, Inc. in the U.S. and other countries.