

14 dB Coupler
5-1000MHz

MACP-008311-CE0370
V1

Features

- Surface Mount
- 14 dB Coupler
- RoHS* Compliant
- RoHS version of ELDC-14
- Available on Tape and Reel. Reel quantity 900

Description

M/A-COM's MACP-008311-CE0370 is a high performance 75 Ohm Coupler, in an SM-55 low cost, surface mount package. The ELDC-14 is designed for use in high volume CATV applications. Typical applications include Set-top Boxes, Network Interface Units, Cable Amplifiers and Headend equipment.

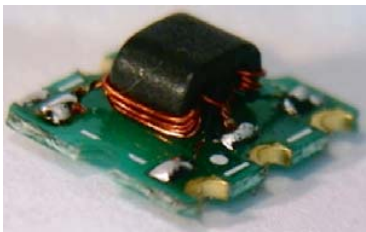

Schematic

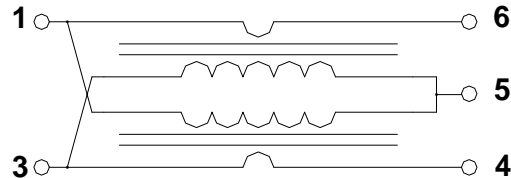

Pin Configuration

Pin No.	Function
1	Output
2	Not connected (ground)
3	External 75 Ohm
4	Coupled
5	Ground
6	Input

Case Style: SM-55

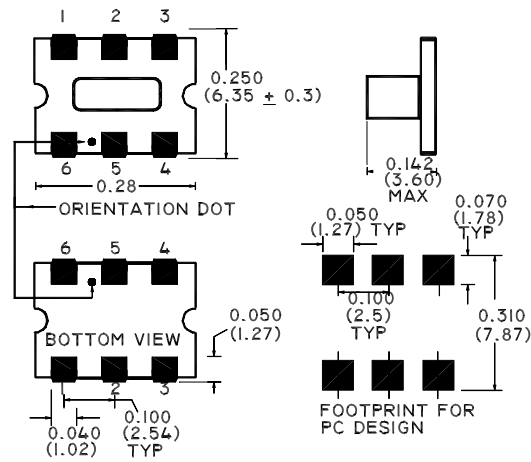

Dimensions in inches [mm] Tolerance: .xx ± .02, .xxx ± .010

Ordering Information

Part Number	Package
MACP-008311-CE0370	900 per reel
MACP-008311-CE03TB	Customer Test Board

Note: Reference Application Note **M513** for reel size information.

* Restrictions on Hazardous Substances, European Union Directive 2002/95/EC.

1

M/A-COM Inc. and its affiliates reserve the right to make changes to the product(s) or information contained herein without notice. M/A-COM makes no warranty, representation or guarantee regarding the suitability of its products for any particular purpose, nor does M/A-COM assume any liability whatsoever arising out of the use or application of any product(s) or information.

- **North America** Tel: 800.366.2266 / Fax: 978.366.2266
- **Europe** Tel: 44.1908.574.200 / Fax: 44.1908.574.300
- **Asia/Pacific** Tel: 81.44.844.8296 / Fax: 81.44.844.8298

Visit www.macom.com for additional data sheets and product information.

14 dB Coupler
5-1000MHz

MACP-008311-CE0370
V1

Electrical Specifications: $T_A = 25^\circ\text{C}$, $Z_0 = 75\Omega$ ¹

Parameter	Test Conditions	Units	Min	Typ	Max
Mainline Loss	5 - 870 MHz	dB	—	0.8	1.5
	870 - 1000 MHz	dB	—	1.0	1.8
Coupling	5 - 870 MHz	dB	—	14.3	± 0.5
	870 - 1000 MHz	dB	—	14.3	± 0.7
Coupling Flatness		dB	—	—	0.8
Directivity	5 - 870 MHz	dB	15	25	—
	870 - 1000 MHz	dB	13	20	—
Input Return Loss	5 - 870 MHz	dB	20	25	—
	870 - 1000 MHz	dB	18	23	—
Output Return Loss	5 - 870 MHz	dB	20	25	—
	870 - 1000 MHz	dB	20	25	—
Coupled Return Loss	5 - 870 MHz	dB	18	23	—
	870 - 1000 MHz	dB	18	23	—

Absolute Maximum Ratings^{1,2}

Parameter	Absolute Maximum
RF Power	250 mW
DC current	30 mA
Pin Temperature (10 sec)	260°C
Operating/Storage Temperature	-40°C to +85°C

- Exceeding any one or combination of these limits may cause permanent damage to this device.
- M/A-COM does not recommend sustained operation near these survivability limits.

Recommended PCB Configuration

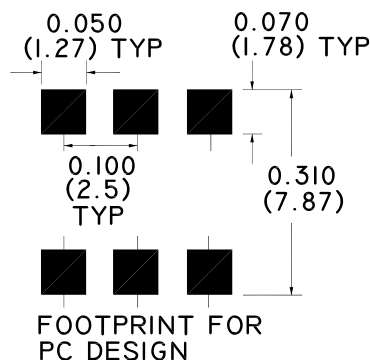

2

M/A-COM Inc. and its affiliates reserve the right to make changes to the product(s) or information contained herein without notice. M/A-COM makes no warranty, representation or guarantee regarding the suitability of its products for any particular purpose, nor does M/A-COM assume any liability whatsoever arising out of the use or application of any product(s) or information.

- **North America** Tel: 800.366.2266 / Fax: 978.366.2266
- **Europe** Tel: 44.1908.574.200 / Fax: 44.1908.574.300
- **Asia/Pacific** Tel: 81.44.844.8296 / Fax: 81.44.844.8298

Visit www.macom.com for additional data sheets and product information.

Typical Performance Curves: $T_A = 25^\circ\text{C}$, $Z_0 = 75\Omega$ ¹

Mainline Loss

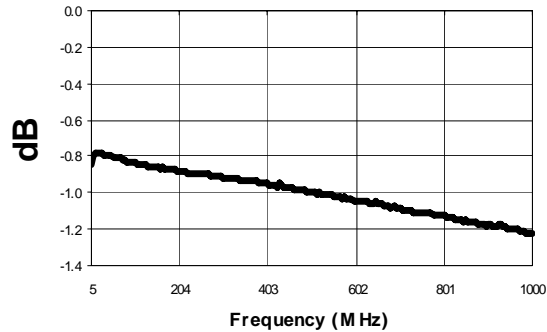

Input Return Loss

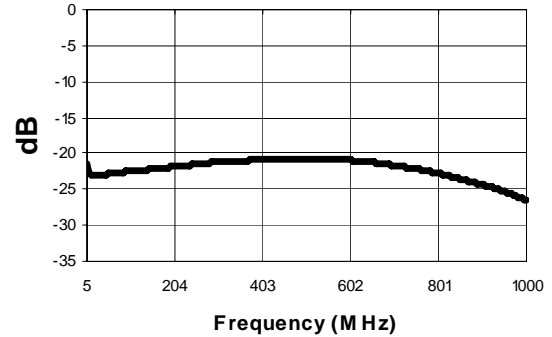

Coupling

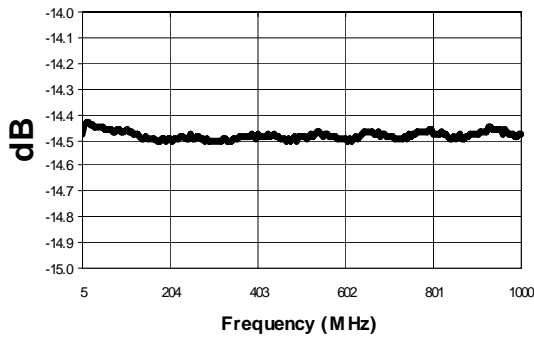

Output Return Loss

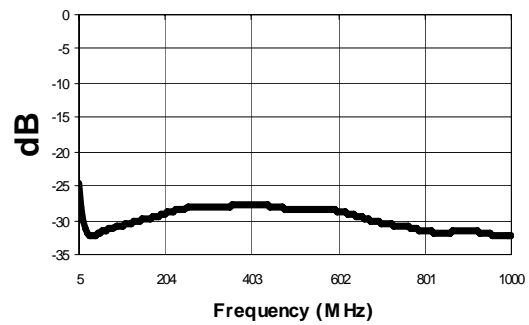

Directivity

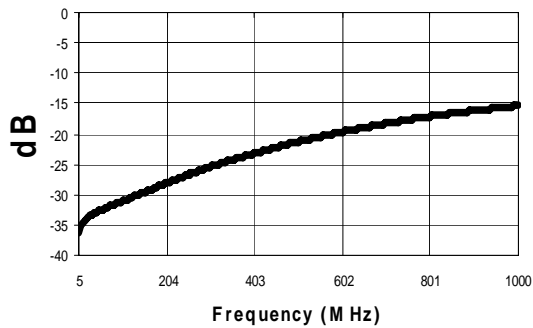

Coupled Port Return Loss

