

MOS FIELD EFFECT POWER TRANSISTOR  
2SJ128

FAST SWITCHING  
P-CHANNEL SILICON POWER MOS FET  
INDUSTRIAL USE

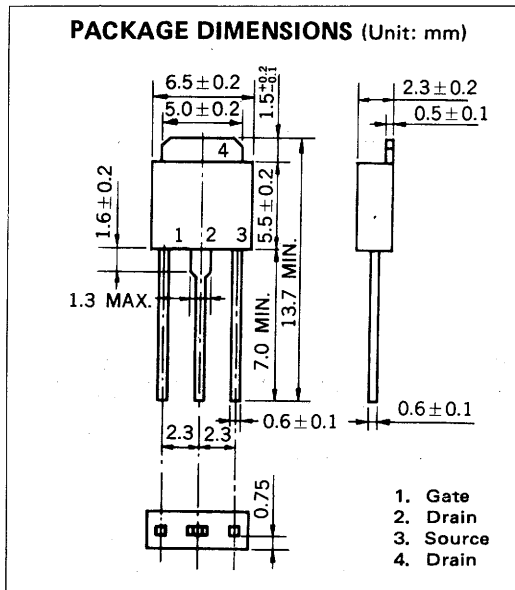

**FEATURES**

- Suitable for switching power supplies, actuator controls, and pulse circuits.
- Low  $R_{DS(on)}$
- No second breakdown
- 4 V Gate Drive – Logic level –

**ABSOLUTE MAXIMUM RATINGS ( $T_A = 25^\circ\text{C}$ )**

Drain to Source Voltage	$V_{DSS}$	-100	V
Gate to Source Voltage	$V_{GSS}$	$\pm 20$	V
Continuous Drain Current	$I_{D(DC)}$	$\mp 2$	A
Peak Drain Current	$I_{D(pulse)*}$	$\mp 8$	A
Total Power Dissipation	$P_T$	20	W
Channel Temperature	$T_{ch}$	150	$^\circ\text{C}$
Storage Temperature	$T_{stg}$	-55 to +150	$^\circ\text{C}$

\*  $PW \leq 300 \mu\text{s}$ , Duty Cycle  $\leq 10\%$

**ELECTRICAL CHARACTERISTICS ( $T_A = 25^\circ\text{C}$ )**

CHARACTERISTIC	SYMBOL	MIN.	TYP.	MAX.	UNIT	TEST CONDITIONS
Drain Leakage Current	$I_{DSS}$			-10	$\mu\text{A}$	$V_{DS} = -100\text{ V}$ , $V_{GS} = 0$
Gate to Source Leakage Current	$I_{GSS}$			$\mp 100$	nA	$V_{GS} = -20\text{ V}$ , $V_{DS} = 0$
Gate to Source Cutoff Voltage	$V_{GS(off)}$	-1.0		-3.0	V	$V_{DS} = -10\text{ V}$ , $I_D = -1\text{ mA}$
Forward Transfer Admittance	$ y_{fs} $	1.0			S	$V_{DS} = -10\text{ V}$ , $I_D = -1\text{ A}$
Drain to Source On-State Resistance	$R_{DS(on)}$		0.8	1.0	$\Omega$	$V_{GS} = -10\text{ V}$ , $I_D = -1\text{ A}$
Drain to Source On-State Resistance	$R_{DS(on)}$		1.1	1.5	$\Omega$	$V_{GS} = -4\text{ V}$ , $I_D = -0.8\text{ A}$
Input Capacitance	$C_{iss}$		1000		pF	$V_{DS} = -10\text{ V}$ , $V_{GS} = 0$ $f = 1\text{ MHz}$
Output Capacitance	$C_{oss}$		200		pF	
Reverse Transfer Capacitance	$C_{rss}$		25		pF	
Turn-On Delay Time	$t_{d(on)}$		30		ns	$I_D = -1\text{ A}$ , $V_{CC} = -50\text{ V}$ $V_{GS(on)} = -10\text{ V}$ $R_L = 10\ \Omega$ $R_{in} = 10\ \Omega$
Rise Time	$t_r$		30		ns	
Turn-Off Delay Time	$t_{d(off)}$		110		ns	
Fall Time	$t_f$		40		ns	

TURN-ON AND TURN-OFF TIME TEST CIRCUIT

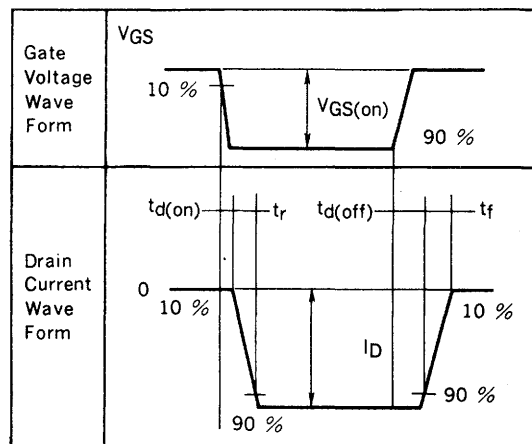
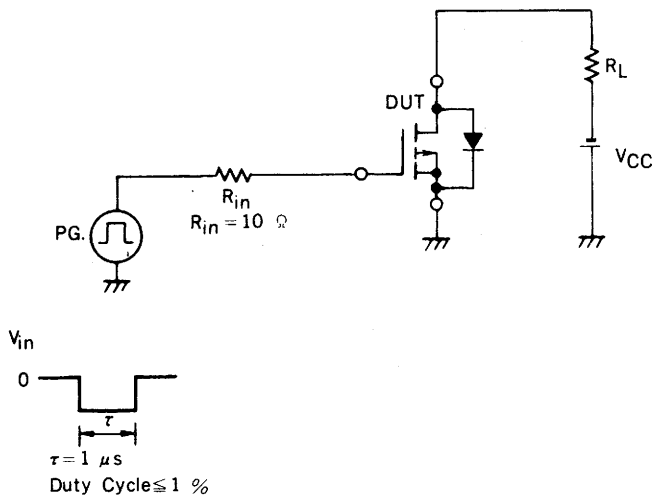

TYPICAL CHARACTERISTICS ( $T_A = 25^\circ C$ )

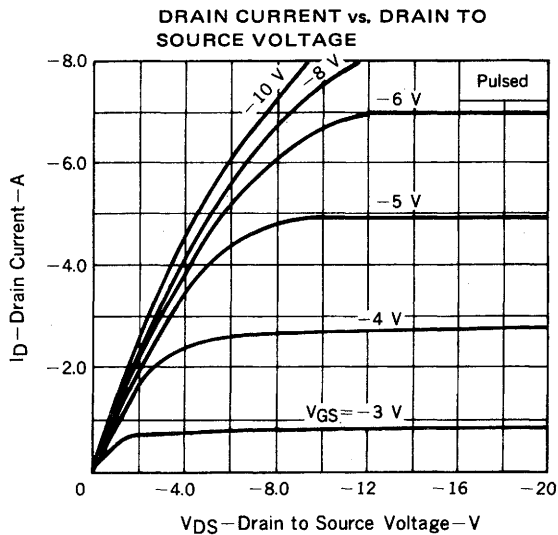
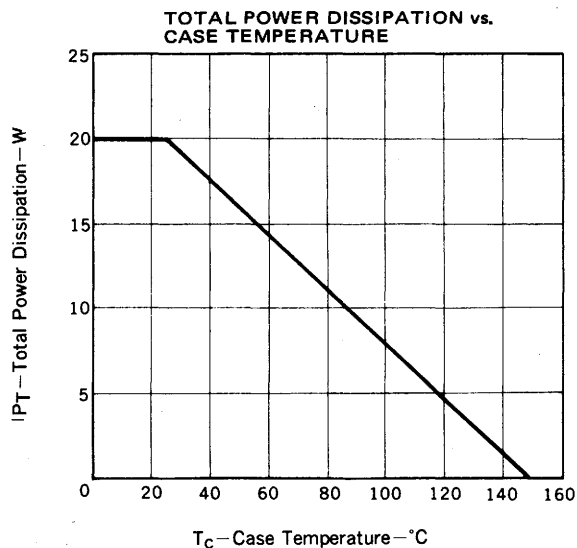
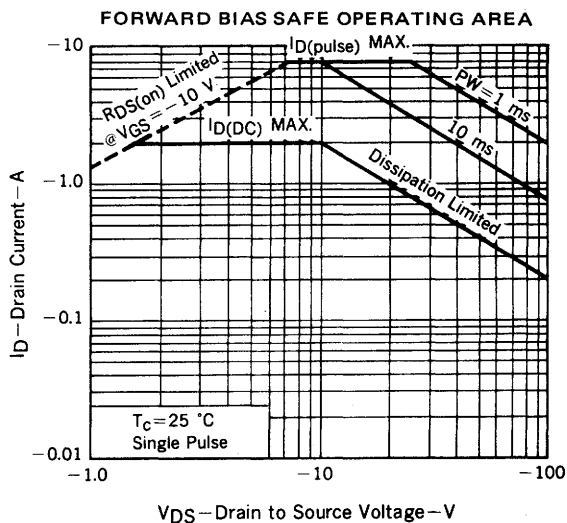
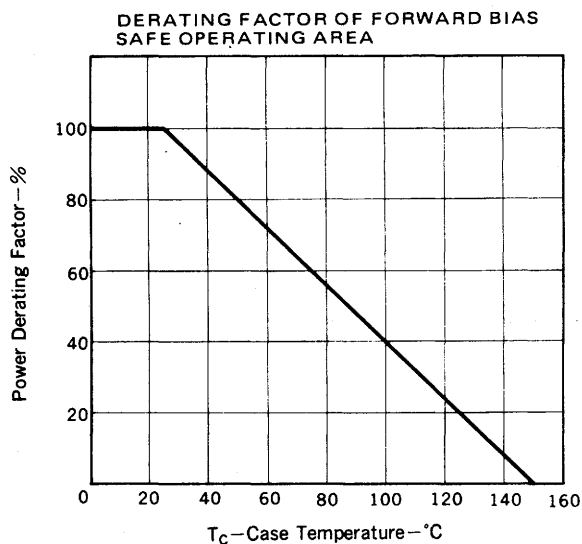

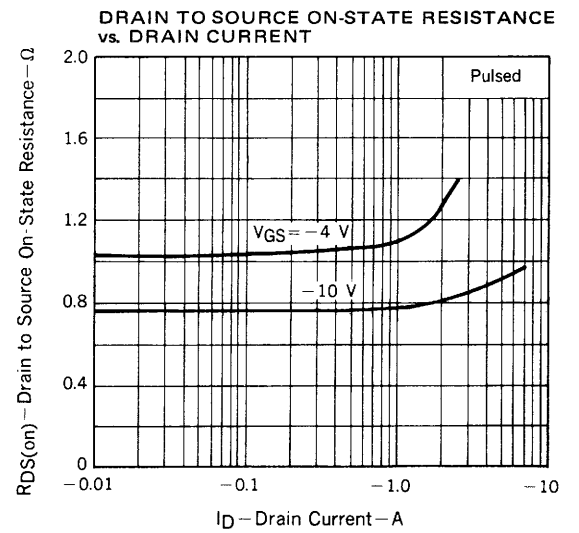
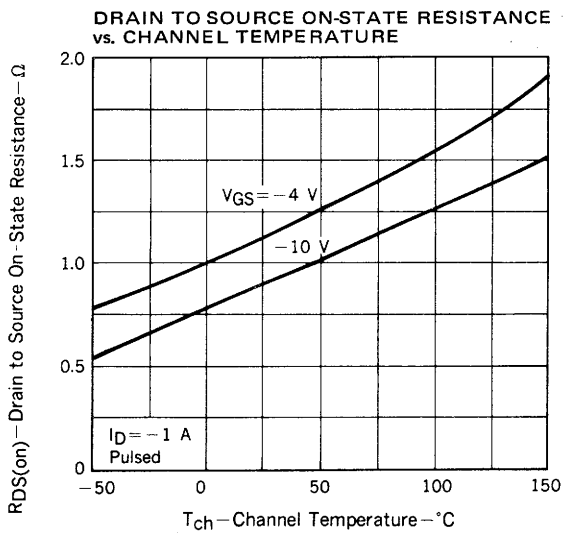
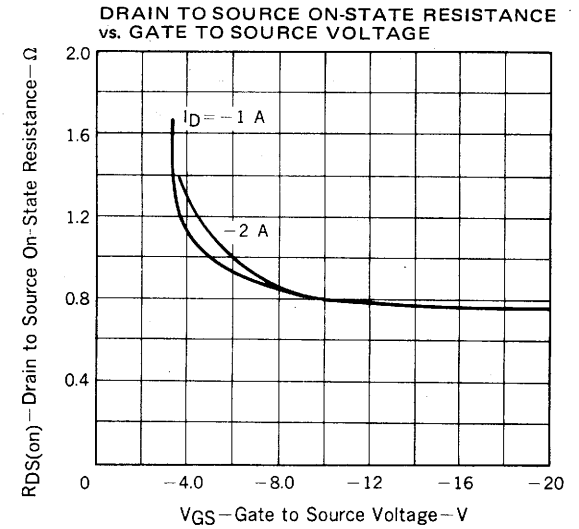
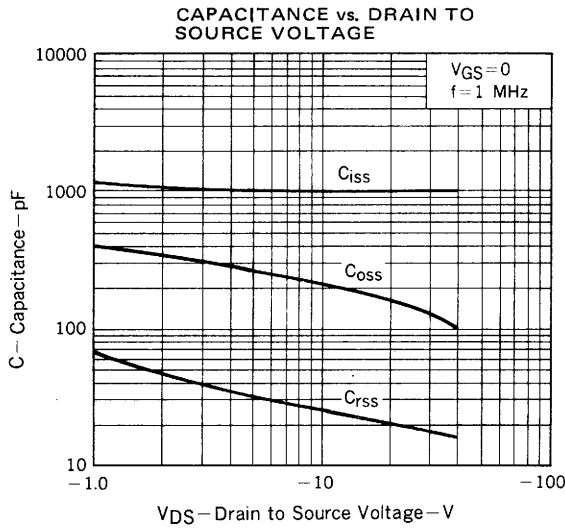
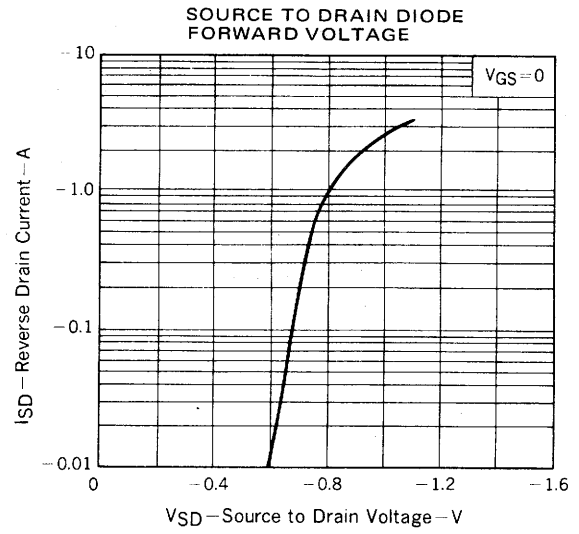
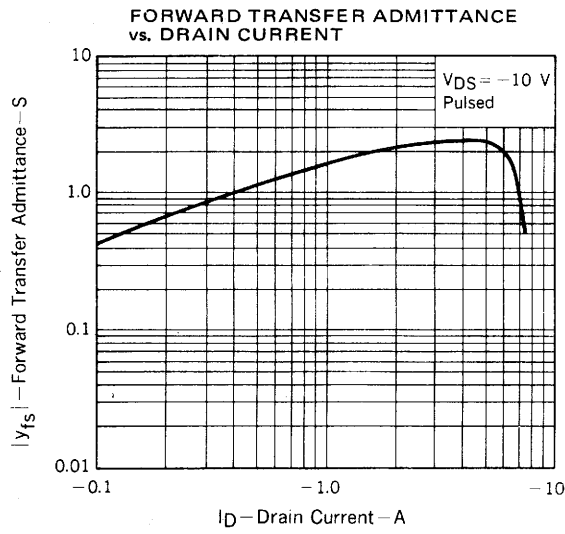

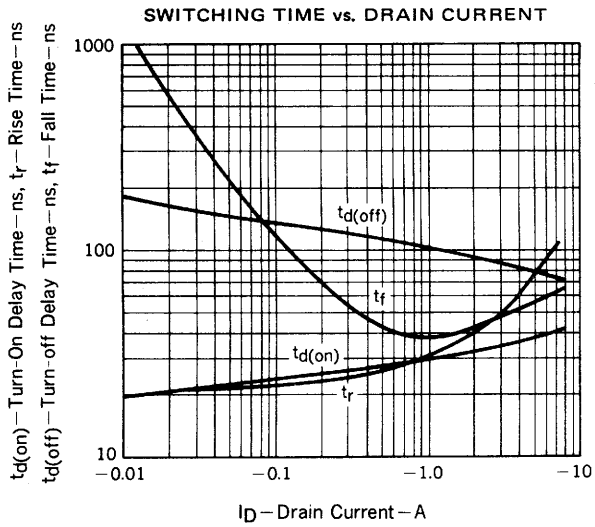
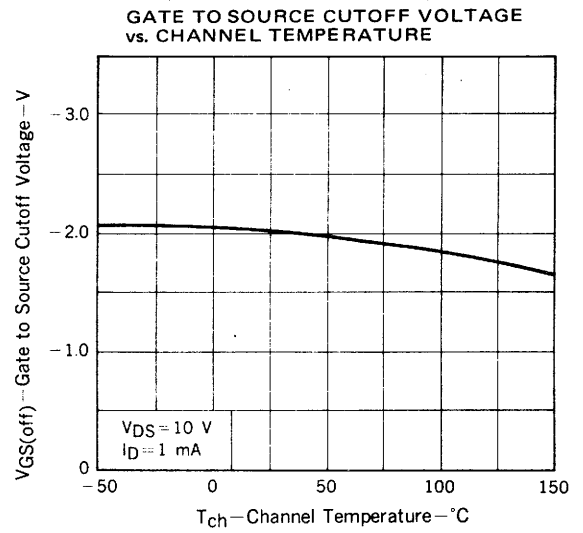
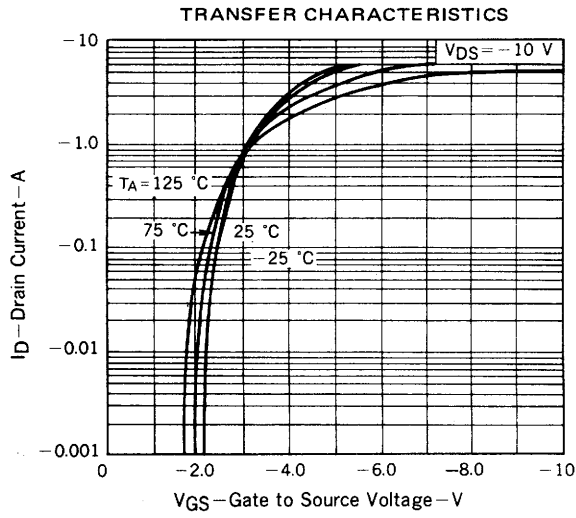

{MEMO}

[MEMO]

[MEMO]

No part of this document may be copied or reproduced in any form or by any means without the prior written consent of NEC Corporation. NEC Corporation assumes no responsibility for any errors which may appear in this document.

NEC Corporation does not assume any liability for infringement of patents, copyrights or other intellectual property rights of third parties by or arising from use of a device described herein or any other liability arising from use of such device. No license, either express, implied or otherwise, is granted under any patents, copyrights or other intellectual property rights of NEC Corporation or others.

While NEC Corporation has been making continuous effort to enhance the reliability of its semiconductor devices, the possibility of defects cannot be eliminated entirely. To minimize risks of damage or injury to persons or property arising from a defect in an NEC semiconductor device, customers must incorporate sufficient safety measures in its design, such as redundancy, fire-containment, and anti-failure features.

NEC devices are classified into the following three quality grades:

"Standard", "Special", and "Specific". The Specific quality grade applies only to devices developed based on a customer designated "quality assurance program" for a specific application. The recommended applications of a device depend on its quality grade, as indicated below. Customers must check the quality grade of each device before using it in a particular application.

**Standard:** Computers, office equipment, communications equipment, test and measurement equipment, audio and visual equipment, home electronic appliances, machine tools, personal electronic equipment and industrial robots

**Special:** Transportation equipment (automobiles, trains, ships, etc.), traffic control systems, anti-disaster systems, anti-crime systems, safety equipment and medical equipment (not specifically designed for life support)

**Specific:** Aircrafts, aerospace equipment, submersible repeaters, nuclear reactor control systems, life support systems or medical equipment for life support, etc.

The quality grade of NEC devices is "Standard" unless otherwise specified in NEC's Data Sheets or Data Books. If customers intend to use NEC devices for applications other than those specified for Standard quality grade, they should contact an NEC sales representative in advance.

Anti-radioactive design is not implemented in this product.