

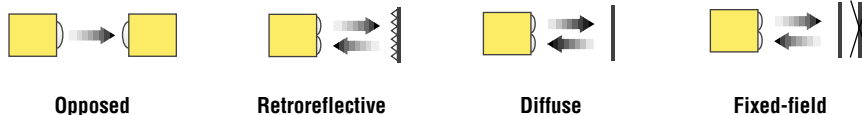

Features

- Low cost and easy to use; no adjustments are necessary
- Models available for opposed (through-beam), retroreflective, polarized retroreflective, diffuse and fixed-field modes
- Advanced self-diagnostics with separate alarm output; dual LED system indicates sensor performance
- 4-pin quick-disconnect connector for SDS Euro-style extension cables
- Epoxy-encapsulated circuitry; leakproof IP67 (NEMA 6P) rating for harsh sensing environments
- Brackets available for several mounting options

T18XSD Sensing Mode Options



Description

T18XSD Series EZ-BEAM sensors are designed specifically for use on SDS™ Bus Networks. These are smart sensors which can be wired directly to an SDS bus using a "dumb" tee.

T18XSD Series sensors offer all of the features and powerful sensing performance that EZ-BEAMs offer. The innovative dual-indicator system takes the guesswork out of sensor performance monitoring. Housings are tightly sealed and the sensor circuitry is epoxy-encapsulated for reliable duty in wet or oily sensing environments. Models are available for opposed (through-beam), retroreflective, polarized retroreflective, diffuse and fixed-field sensing.

Several mounting options are offered, including angled brackets and split-clamp brackets. T18XSD series sensors may also be simply mounted through suitable clearance holes. See page 5 for more information.

[†] U.S. Patent #5087838

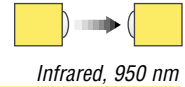
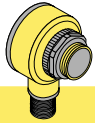

Opposed Mode Emitter (E) and Receiver (R)

Models	Range	Cable	Supply Voltage	Excess Gain	Beam Pattern
T18XSD1EQ	20 m (66')	4-pin Euro QD	11-25V dc		
T18XSD1RQ					

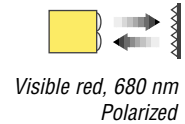
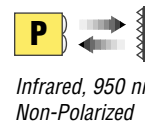
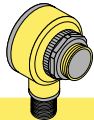

Retroreflective Mode

Models	Range	Cable	Supply Voltage	Excess Gain	Beam Pattern
Polarized					
T18XSD1LPQ	2 m (79")	4-pin Euro QD	11-25V dc		
Non-Polarized					
T18XSD1LQ	2 m (79")	4-pin Euro QD	11-25V dc		

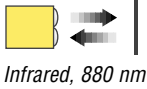

Diffuse Mode

Models	Range	Cable	Supply Voltage	Excess Gain	Beam Pattern
				Performance based on 90% reflectance white test card	
T18XSD1DQ	500 mm (20")	4-pin Euro QD	11-25V dc		

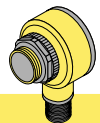
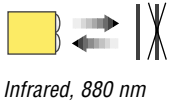

Fixed-Field Mode

Models	Range	Cable	Supply Voltage	Excess Gain
				Performance based on 90% reflectance white test card
25 mm far limit cutoff				
T18XSD1FF25Q	25 mm (1")	4-pin Euro QD	11-25V dc	
50 mm far limit cutoff				
T18XSD1FF50Q	50 mm (2")	4-pin Euro QD	11-25V dc	
100 mm far limit cutoff				
T18XSD1FF100Q	100 mm (4")	4-pin Euro QD	11-25V dc	

T18XSD Series Specifications

Supply Voltage and Current	11 to 25V dc (10% maximum ripple); Supply current (exclusive of load current): Opposed-Mode Emitter: 25 mA Opposed-Mode Receiver: 45 mA Polarized & Non-polarized Retro: 55 mA Diffuse: 55 mA Fixed-field: 60 mA
Supply Protection Circuitry	Protected against reverse polarity and transient voltages
Output Protection Circuitry	Protected against false pulse on power-up and continuous overload or short-circuit of outputs
Output Response Time	Opposed: 3.5 milliseconds ON and 2.0 milliseconds OFF Polarized Retro and Fixed-field: 3.5 milliseconds ON and OFF <i>NOTE: 100 millisecond delay on power-up; outputs do not conduct during this time</i>
Repeatability	Opposed: 575 microseconds Polarized Retro and Fixed-field: 950 microseconds Repeatability and response are independent of signal strength
Indicators	Two LEDs: One Green LED and one Yellow LED Green LED: indicates Power to the sensor Yellow LED: indicates the sensor signal Yellow LED glowing steady: normally open output is conducting Yellow LED flashing: excess gain marginal (1-1.5x) in light condition
Construction	Housings are PBT thermoplastic polyester; Lenses are Lexan® (opposed models) or acrylic (retro and fixed-field models) T18XSD comes with one jam nut
Environmental Rating	Leakproof design rated NEMA 6P; IEC IP67
Connections	4-pin Euro-style SDS compatible quick-disconnect fitting; cables are ordered separately - interlinkBT
Operating Conditions	Operating temperature: -25° to +70°C (-13° to +158°F) Maximum relative humidity: 90% at 50°C (non-condensing)
Vibration and Mechanical Shock	All models meet Mil. Std. 202F requirements. Method 201A (Vibration; frequency 10 to 60 Hz, max., double amplitude 0.06-inch acceleration 10G). Method 213B conditions H&I (Shock: 75G with unit operating; 100G for non-operation)

Dimensions and Features

T18XSD
(All models except emitter)

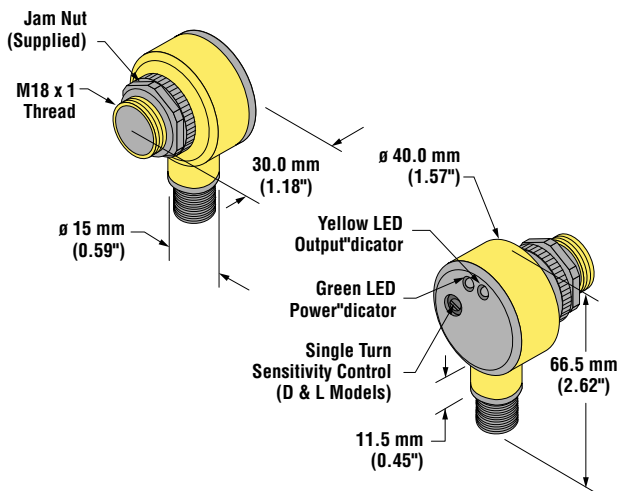

T18XSD Emitter

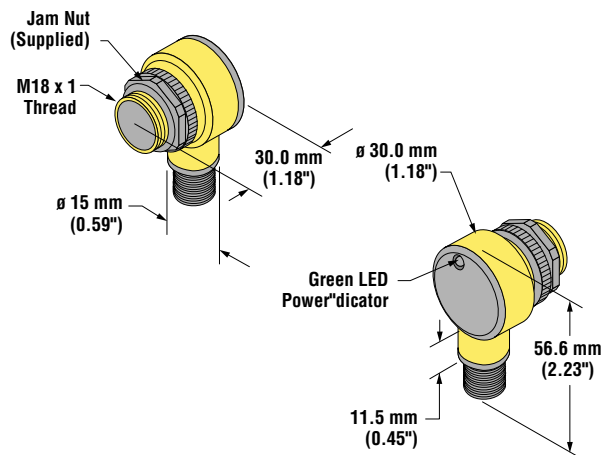

Hookups

Quick-Disconnect Pin Detail (Except Emitter)
connector on sensor shown (male pins)

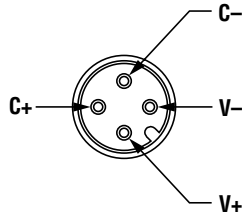

Emitter Quick-Disconnect Pin Detail
connector on sensor shown (male pins)

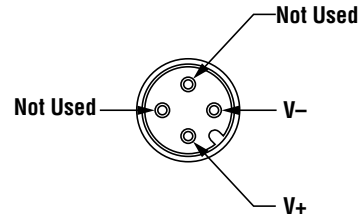

Contact factory or interlinkBT for mating cable information

Mounting Brackets

Mounting Brackets	
<p>SMB18A</p> <ul style="list-style-type: none"> 12-gauge, stainless steel, right-angle bracket, curved mounting slot for versatility and orientation Clearance for M4 (#8) hardware 	<p>SMB18C</p> <ul style="list-style-type: none"> 18 mm split clamp bracket Black thermoplastic polyester Includes stainless steel mounting hardware
<p>* Use 4 mm (#8) screws to mount bracket. Drill screw holes 24.2 mm (0.95") apart.</p>	
<p>SMB18Q</p> <ul style="list-style-type: none"> 18 mm angled flanged bracket Stainless steel Includes stainless steel mounting hardware 	<p>SMB18S</p> <ul style="list-style-type: none"> 18 mm swivel bracket black thermoplastic polyester Includes stainless steel mounting hardware
<p>* Use 4 mm (#8) screws to mount bracket. Drill screw holes 24.2 mm (0.95") apart.</p>	



T18XSD Series

SDS Model Specification for T18XSD

The T18XSD conforms to the following SDS model:

Level 4 Binary Input, 1.1.1.5

Attributes

Attribute	Description	R/W	Data Type	Size	Count	Default value
0	Network Data Descriptor	R	Unsigned	Byte	6	18,1,0,0,0,0
1	Baud Rate	R	Unsigned	Byte	1	0
2	Object Type	R	Unsigned	Byte	4	1,1,1,5
3	Partner ID	R	Unsigned	Word	1	50
4	Device Address	R	Unsigned	Byte	1	125
6	Unsolicited Mode Enable	R/W	Boolean	Undefined	1	1
7	Software Version	R	Character	Undefined	11	XXXXX - X.X
8	Diagnostic Error Counter	R	Unsigned	Byte	1	
9	Diagnostic Register	R/W	Unsigned	Byte	2	
10	Cyclic Timer	R/W	Unsigned	Byte	1	0
11	Serial Number	R	Unsigned	Long	1	XX...X
12	Date Code	R	Character	Undefined	4	MMYY
13	Catalog Listing	R	Character	Undefined	24	T18XSD1XXX (Model number)
14	Partner Name	R	Character	Undefined	24	"Banner Engineering"
15	Component Name	R	Character	Undefined	24	"Photoelectric Sensor"
18	Input Data	R	Boolean	Undefined	1	-
51	Direct Input State	R	Unsigned	Byte	1	-
56	Tag Name	R/W	Character	Undefined	24	Blank
58	Diagnostic Count Limit	R/W	Unsigned	Byte	1	1
60	NO/NC	R/W	Boolean	Undefined	1	0
61	Configuration Register	R/W	Unsigned	Byte	1	0

Attributes

Attribute	Description	Action	
0	I/O Type	18,1,0,0,0,0 These six bytes indicate that this is a single point binary input with the input variable at Attribute #18.	
1	Baud Rate	Always returns 0. This indicates that this device automatically determines the correct baud rate for communication.	
2	Device Type	Indicates type of device in terms of the SDS protocol. This is presented as 4 X 8 bit words: 01.01.01.05 hex.	
3	Vendor Identification Number	50 decimal.	
4	Device Address	This variable indicates the network address of the device 0-125. It is the logical SDS address minus 1. If the SDS address of this device is 1 this attribute will be 0. Default value is 125 decimal. This attribute is stored in non-volatile memory.	
6	Unsolicited Mode Enable	Setting this bit allows the device to send I/O event driven messages. These event messages include: COS ON, COS OFF, WRITE ON, WRITE OFF. If this bit is cleared, then only the error event (event 0) is generated. All other events will be disabled. This attribute is stored in non-volatile memory.	
7	Software version Number	ASCII character string "XXXXX-X.X"	
8	Diagnostic Error Counter	The Diagnostic Error Counter indicates the number of error flags that are currently set in attribute #9. The possible values of this counter are 0, 1, 2, 3 or 4.	
9	Bus Diagnostics Register	This is a 2 byte read or write register. When an error occurs, the corresponding bit is set.	
		Byte 1	Byte 2
		bit 0 ROM Checksum Error	bit 0 not used = 0
		bit 1 not used = 0	bit 1 not used = 0
		bit 2 Off-Bus error	bit 2 not used = 0
		bit 3 reserved = 0	bit 3 reserved = 0
		bit 4 reserved = 0	bit 4 reserved = 0
		bit 5 not used = 0	bit 5 not used = 0
		bit 6 not used = 0	bit 6 Low Gain Alarm
bit 7 EEPROM Failure	bit 7 not used = 0		
10	Cyclical Timer	Setting to a non-zero value will enable unsolicited WRITE-ON or WRITE-OFF messages to be transmitted with a real time interval equal to 10.24 ms multiplied by the set value. These messages will reflect the current state of the input variable (attribute #18). This attribute is stored in non-volatile memory.	

Attributes

Attribute	Description	Action
11	Serial Number	Unique number used to differentiate products prior to address assignment. The firmware waits for a random period of up to 10 ms before responding to a read of this attribute. This makes it possible to detect two nodes with the same address.
12	Date Code	ASCII string that identifies date of manufacture.
13	Catalog listing	ASCII string = "T18XSD1XXX" (Model number)
14	Vendor Name	ASCII String = "Banner Engineering"
15	Device Name	ASCII String = "Photoelectric Sensor"
18	Input Variable	This reflects the state of the sensor output: 0 = Dark, 1 = Light. The logical state of this attribute can be inverted by setting attribute 61, NO/NC. The state of this attribute may also be forced by using action 51, Force State.
51	Direct Input State:	<p>This is a single byte, 8 flags.</p> <ul style="list-style-type: none"> bit 0 Real time sense level, high when excess gain > 1 bit 1 Real time diagnostics signal, high when excess gain > 2.5 (Sensor sees Light, and Alarm is off) bits 2 to 7 = 0, not used. <p>Possible values of Attribute 51 are:</p> <ul style="list-style-type: none"> 51 = 0 Dark 51 = 1 Low Gain 51 = 3 Light; The NO/NC bit (attribute #60) does not affect this register.
56	Tag Name	This is a read/write 24 character ASCII string. This attribute is stored in non-volatile memory.
58	Diagnostic Count Limit	<p>Each time a low gain condition occurs, it is counted. When that count reaches the diagnostic count limit, the diagnostic register is updated and an event 0 is sent. Here are some possible values for the diagnostic count limit:</p> <ul style="list-style-type: none"> 0 = Low gain alarm disabled 1 = Low gain bit set each time low gain condition occurs 20 = Low gain bit is set after 20 low gain conditions
60	NO/NC	Setting this bit will invert the Input State (attribute 18). This attribute is stored in non-volatile memory
61	Configuration Register	<p>This is a single byte, 8 flags.</p> <ul style="list-style-type: none"> bits 0 to 2 Not used. bit 3 Disable re-transmission of COS messages R/W. When this bit is set ALL event driven messages are sent only once per event. Unacknowledged messages are not resent. bits 4 to 7 Not used. <p>This attribute is stored in non-volatile memory.</p>

Actions

Action	Description	Requested Data	Requested Data Type	Response Data	Response Data Type
0	No Operation	None		None	
1	Change Address	New Address Device ID* Device ID* Serial No.*	Unsigned 8 Unsigned 8 Unsigned 16 Unsigned 32	None	
2	Self Test	None		None	
6	Clear All Errors	None		None	
8	Enroll Logical Device	None		Partner ID Serial No.	Unsigned 16 Unsigned 32
51	Force Input	Input State	Unsigned 8	None	
52	Remove Forced Input	None		None	
53	Read Primitive Tag	Attribute ID		Attribute ID Primitive Tag	Unsigned 8 Unsigned 32

* These parameters are optional

Action	Description	Action
0	NO-OP	This is used primarily during “Autobaud” and to solicit a response from another node to verify bus integrity. No action is performed by our device.
1	Change Address	There are two methods to change the address. <ul style="list-style-type: none"> • If the message contains one or two data bytes, the address is changed to the address defined by the first byte. The second byte is ignored. • If the message contains eight data bytes, then bytes 3 and 4 are checked against the Vendor ID. Bytes 5-8 are checked against the Serial Number. If the Vendor ID and Serial Number are correct, then byte 1 is used to determine the new address. If either is not correct, the message is ignored.
2	Initiate Self Test	This action initiates a self test sequence internal to the node. This action is acknowledged prior to the start of the self test. An Event ID 0 is then transmitted only if internal errors are found.
6	Reset Errors	This action clears the error flags in both bytes of attribute #9, Bus Diagnostic Register.
8	Enroll	Enroll returns a 6 byte message. The first four data bytes are the Serial Number and the remaining two bytes are the Vendor Identification Number. The firmware waits for a random delay, up to 10 ms, before responding to this action. This delay makes it possible to detect multiple devices with the same logical address.
51	Force Input/Output Variable State	This forces the logical state of the Input, Attribute #18. The data contains a Boolean single byte: 00 or 01.
52	Remove Force Input/Output Variable State	This function removes the forced state, and restores normal operation.
53	Read Primitive Tag	This action is called with one byte of input data - the attribute number. This action responds with the following 3 bytes of data: Attribute # (unsigned 8), Primitive Tag (unsigned 16).



T18XSD Series

Events

Event	Description	Output Data Parameters	Output Data Parameter Type
0	Diagnostic Event Counter Write ON Write OFF Change of State ON Change of State OFF	Counter Value None None None None	Unsigned 8

Event	Description	Action
0	Diagnostic Event Counter	This event is sent when ever a flag in attribute 9 is set. This event also sends one data byte. This byte contains the value of attribute #8, the Diagnostic Error Counter. Typically, this event is sent as a result of a low gain condition.
	Write ON/OFF	These events are sent when the Cyclic Timer has expired. Either a WRITE ON or a WRITE OFF special event is sent reflecting the state of the input. This event can be masked by clearing attribute 6.
	Change of State ON	When the output of the sensor transitions to the ON state, this message is sent. This event can be masked by clearing attribute 6.
	Change of State OFF	When the output of the sensor transitions to the OFF state this message is sent. This event can be masked by clearing attribute 6.



T18XSD Series



the photoelectric specialist

WARRANTY: Banner Engineering Corp. warrants its products to be free from defects for one year. Banner Engineering Corp. will repair or replace, free of charge, any product of its manufacture found to be defective at the time it is returned to the factory during the warranty period. This warranty does not cover damage or liability for the improper application of Banner products. This warranty is in lieu of any other warranty either expressed or implied.



WARNING . . . Not To Be Used for Personnel Protection

Never use these products as sensing devices for personnel protection. Doing so could lead to serious injury or death.

These sensors do NOT include the self-checking redundant circuitry necessary to allow their use in personnel safety applications. A sensor failure or malfunction can cause either an energized or de-energized sensor output condition. Consult your current Banner Safety Products catalog for safety products which meet OSHA, ANSI and IEC standards for personnel protection.