

SURGE TRAP[®] Surge Protective Device

SURGE SUPPRESSION



THE NO-FUSE SURGE SUPPRESSOR

DIN RAIL TVSS (THERMALLY PROTECTED)

The Surge Trap Surge Protective Device from Ferraz Shawmut is an innovative enhancement to the existing TPMOV[®] (Thermally Protected MOV) product line. The Surge-Trap provides a patented, thermally protected MOV that does not require additional overcurrent protection due to the high interrupting rating. It also offers the flexibility to be connected individually or ganged together. Each individual mode has a visual and remote indicator to provide status to critical control circuits.

APPLICATION:

- AC/DC distribution
- Power supplies
- Industrial automation
- Telecommunications
- Motor controls and starter systems
- Programmable logic controller (PLC) applications
- Power transfer equipment
- HVAC applications
- AC drives
- UPS systems
- Security systems
- IT / Data centers
- Medical equipment

Ratings

- 100kA SCCR
- 50kA 8/20 μ s surge capacity (per mode)
- 100kA 8/20 μ s surge capacity (per phase)
- Surge life @ 3kA-8/20 μ s: 5000 events
- Surge life @ 10kA-8/20 μ s: 1000 events
- Operating and storage temperature: -40°C to +85°C
- Wiring range: #6 to #14 AWG

Approvals

- UL 1449 Third Edition, File No E210793
- Type 4 UL Recognized Component (tested to SPD Type 2)
- IEC 61643-1
- ANSI/IEEE C62.41
- CE
- RoHS compliant



Features/Benefits

- Easy installation or retrofit
- Din-rail mountable
- Fail-safe /self-protected design
- Remote indicator (optional) with 3 pin NO/NC contact
- IP20 finger-safe design
- Visual indicator
- Small foot print

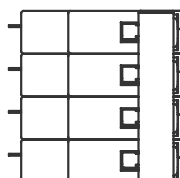
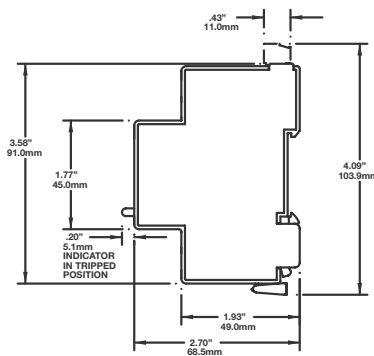
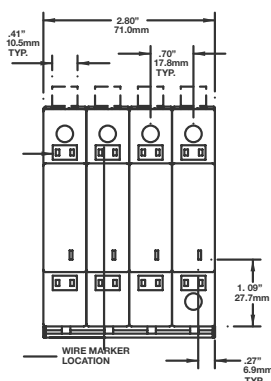

** UL FILE #E210793
 ** WIRE SIZE: 6-14 AWG
 ** TORQUE: 14.75 LBS-IN
 ** USE 35mm DIN RAIL

SURGE TRAP[®] Surge Protective Device

SURGE SUPPRESSION

Ordering Information

Surge-Trap [®] Catalog Nos.	Nominal Voltage (Vac)	MCOV (L-G)	Phase	No. of Wires	Freq (Hz)	Nominal Discharge Current (In, kA)	SCCR (kA)	Circuit Connection Diagram	Intended End-Use SPD Type	Voltage Protection Rating (VPR)			
										L-N	L-G	N-G	L-L
ST1201PG	120	180	1	2 Wire	50/60	20	100	A	2	600	600	-	-
ST2301PG	240	270	1	2 Wire	50/60	20	100	A	2	800	800	-	-
ST2771PG	277	320	1	2 Wire	50/60	20	100	A	2	1200	1200	-	-
ST2083PY	120/208	360	3Y	5 Wire	50/60	20	100	D	2	1000	600	600	1000
ST2083PYG	120/208	180	3Y	4 Wire	50/60	20	100	C	2	500	500		900
ST208SPG	120/240	180	S	3 Wire	50/60	20	100	B	2	600	600		1000
ST240SPG	120/240	180	S	3 Wire	50/60	20	100	B	2	500	500		900
ST480SPG	240/480	270	S	3 Wire	50/60	20	100	B	2	800	800	-	1500
ST2403PDG	240D	270	3D	4 Wire	50/60	20	100	C	2	800	800	-	1500
ST4803PY	277/480	500	3Y	5 Wire	50/60	20	100	D	2	2000	1200	1200	2000
ST4803PYG	277/480	320	3Y	4 Wire	50/60	20	100	C	2	900	900	-	1800
ST4803PDG	480D	550	3D	4 Wire	50/60	20	100	C	2	1500	1500		3000
ST6003PY	347/600	690	3Y	5 Wire	50/60	20	100	D	2	2500	1500	1500	2500
ST6003PYG	347/600	420	3Y	4 Wire	50/60	20	100	C	2	1200	1200		2000

Phase Key: (S) Split Phase (Y) Wye (D) Delta (See top of page 2)

*Values based upon SPD Type 2 testing

Surge-Trap[®] Voltage Configuration

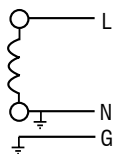

Single Phase
2 Wire + Ground

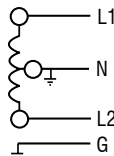

Split Phase
3 Wire + Ground

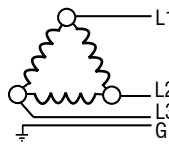

3 Phase Delta
3 Wire + Ground

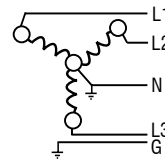

3 Phase Wye
4 Wire + Ground

Choose Your Product

ST	480	3PY	G	M
Surge-Trap [®]	System Voltage 120 - 120V 208 - 208V 230 - 230V 240 - 240V 277 - 277V 480 - 480V 600 - 600V	Voltage Configuration 1P - Single Phase SP - Split Phase 3PD - 3 Phase Delta 3PY - 3 Phase Wye	N/G Blank - Includes N/G Mode G - L-G Mode Only	Auxiliary Microswitch Blank - No Microswitch M - Microswitch Included

Surge-Trap[®] Circuit Connection Wiring Diagram

