

ST SERIES - MINIATURE TOGGLE SWITCHES

A

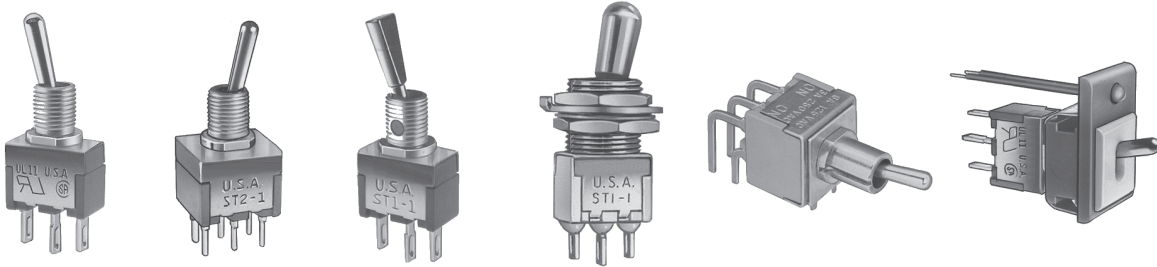

SPECIFICATIONS SUBJECT TO CHANGE WITHOUT NOTICE

FEATURES

- Dry circuit through power ratings .
- Ultra-rugged construction SPDT & DPDT models with numerous options.
- Panel, panel & p.c. and p.c. mounting models, lighted and unlighted.

SPECIFICATIONS

Contact ratings (resistive loads):	(Q) power models - coin silver: 6 Amps at 125 VAC, 3 Amps at 250 VAC or 7 Amps at 30 VDC. (B) dry circuit models - gold over nickel over brass: 0.4 VA max. at 20 V max. UL models - coin silver: 6 Amps at 125 VAC or 3 Amps at 250 VAC (75% power factor). UL file no. E66367. CSA models - coin silver: same ratings as UL models. CSA file no. LR54592-1.
Initial contact resistance:	3 milliohms max. at 3 VDC, 0.1 Amp.
Insulation resistance:	Greater than 200,000 megohms between terminals & case ground.
Dielectric strength:	Greater than 2000 VAC for 1 minute between terminals & case ground.
Electrical life (resistive loads):	100,000 cycles min. for ST1-1 & ST2-1. Other models, 40,000 cycles min.
Operating temperature range:	-30°C to +85°C

MATERIALS

Contacts:	Coin silver for power, UL & CSA models. Gold over nickel over brass for dry circuit models.
Actuator:	Brass, bright nickel or chrome plated.
Bushing:	Nickel plated brass
Strap:	Stainless steel
Case:	Melamine Phenolic, color red
Terminal seal:	Epoxy (optional)
Support bracket:	Brass or steel, tin plated
Spring mounting bracket:	Stainless steel
Bezel & bezel insert:	Nylon. Available in black, red & white. Consult factory for other colors.
Hardware:	See 'Miscellaneous' section.
LED:	Intensity: 2.0 mcd at 10 mA. Forward voltage: 2.0V (3.0V max.). Max. continuous forward current: 15 mA for red, 30 mA for green & 20 mA for yellow. Red is standard. Yellow & green are optional. Specifications are subject to change without notice - consult factory.

AGENCY RECOGNITION



UL, & CSA. Marking: Switches ordered by UL model number are supplied with recognition marking. Switches ordered by UL model no. and with '/CSA' added at end of model no. are supplied with both recognitions marked.

ABOUT THIS SERIES

The material in this series is organized in the following sequence:

- Completely specified switch models
- Miscellaneous
- 'build your own switch' order format
- Option drawings & information
- Panel cut-outs

ST SERIES - MINIATURE TOGGLE SWITCHES

Solder lug terminals - panel mounting

SINGLE POLE



DOUBLE POLE

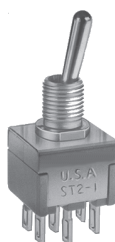

	POWER CKT. MODEL NO.	UL MODEL NO.				Key way
Single pole	ST1-1KMZQ	UL11KMZQ	ON	NONE	ON	
	ST1-2KMZQ	UL12KMZQ	ON	OFF	ON	
	ST1-3KMZQ	UL13KMZQ	MOM	OFF	MOM	
	ST1-4KMZQ	UL14KMZQ	ON	OFF	MOM	
	ST1-5KMZQ	UL15KMZQ	ON	NONE	MOM	
Double pole	ST2-1KMZQ	UL21KMZQ	ON	NONE	ON	
	ST2-2KMZQ	UL22KMZQ	ON	OFF	ON	
	ST2-3KMZQ	UL23KMZQ	MOM	OFF	MOM	
	ST2-4KMZQ	UL24KMZQ	ON	OFF	MOM	
	ST2-5KMZQ	UL25KMZQ	ON	NONE	MOM	
	ST2-6KMZQ	UL26KMZQ	ON	ON	ON	
	ST2-7KMZQ	UL27KMZQ	ON	ON	MOM	
	ST2-8KMZQ	UL28KMZQ	MOM	ON	MOM	
Terminals connected (-6, -7 & -8)			1-2, 4-5	1-2, 5-6	2-3, 5-6	

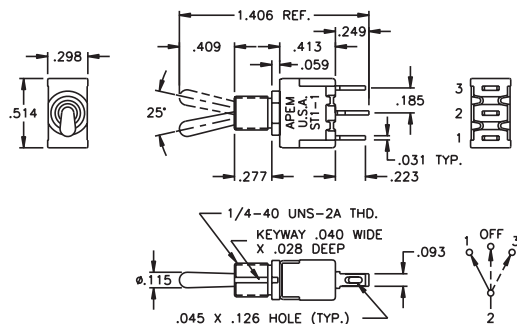

Terminal numbers for reference only

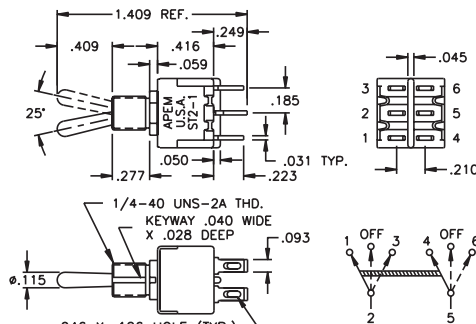

DOUBLE POLE

Straight p.c. terminals - panel mounting

SINGLE POLE

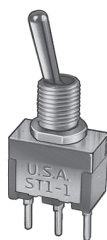

DOUBLE POLE

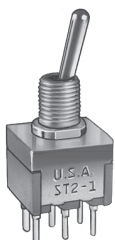

	DRY CKT. MODEL NO.	UL MODEL NO.				Key way
Single pole	ST1-1KMCB	UL11KMCB	ON	NONE	ON	
	ST1-2KMCB	UL12KMCB	ON	OFF	ON	
	ST1-3KMCB	UL13KMCB	MOM	OFF	MOM	
	ST1-4KMCB	UL14KMCB	ON	OFF	MOM	
	ST1-5KMCB	UL15KMCB	ON	NONE	MOM	
Double pole	ST2-1KMCB	UL21KMCB	ON	NONE	ON	
	ST2-2KMCB	UL22KMCB	ON	OFF	ON	
	ST2-3KMCB	UL23KMCB	MOM	OFF	MOM	
	ST2-4KMCB	UL24KMCB	ON	OFF	MOM	
	ST2-5KMCB	UL25KMCB	ON	NONE	MOM	
	ST2-6KMCB	UL26KMCB	ON	ON	ON	
	ST2-7KMCB	UL27KMCB	ON	ON	MOM	
	ST2-8KMCB	UL28KMCB	MOM	ON	MOM	
Terminals connected (-6, -7 & -8)			1-2, 4-5	1-2, 5-6	2-3, 5-6	

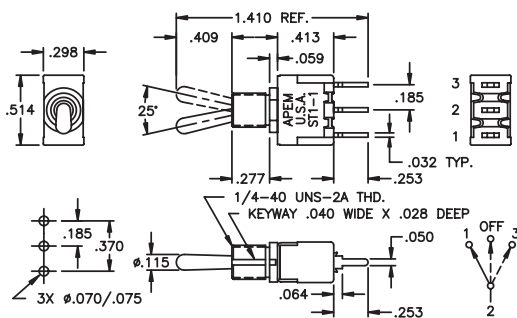

Terminal numbers for reference only

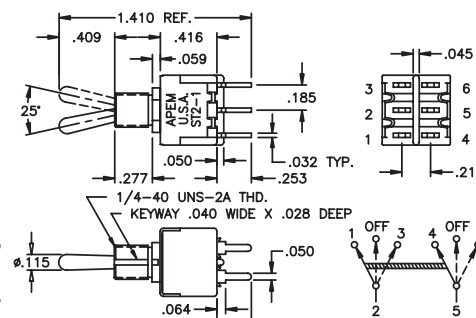

DOUBLE POLE

ST SERIES - MINIATURE TOGGLE SWITCHES

A

Flatted actuator - panel mounting

SINGLE POLE



DOUBLE POLE



	POWER CKT. MODEL NO.	UL MODEL NO.				Key-way
Single pole	ST1-1F1MZQ	UL11F1MZQ	ON	NONE	ON	
	ST1-2F1MZQ	UL12F1MZQ	ON	OFF	ON	
	ST1-3F1MZQ	UL13F1MZQ	MOM	OFF	MOM	
	ST1-4F1MZQ	UL14F1MZQ	ON	OFF	MOM	
	ST1-5F1MZQ	UL15F1MZQ	ON	NONE	MOM	
Double pole	ST2-1F1MZQ	UL21F1MZQ	ON	NONE	ON	
	ST2-2F1MZQ	UL22F1MZQ	ON	OFF	ON	
	ST2-3F1MZQ	UL23F1MZQ	MOM	OFF	MOM	
	ST2-4F1MZQ	UL24F1MZQ	ON	OFF	MOM	
	ST2-5F1MZQ	UL25F1MZQ	ON	NONE	MOM	
	ST2-6F1MZQ	UL26F1MZQ	ON	ON	ON	
	ST2-7F1MZQ	UL27F1MZQ	ON	ON	MOM	
	ST2-8F1MZQ	UL28F1MZQ	MOM	ON	MOM	
Terminals connected (-6, -7 & -8)			1-2, 4-5	1-2, 5-6	2-3, 5-6	

SPECIFICATIONS SUBJECT TO CHANGE WITHOUT NOTICE

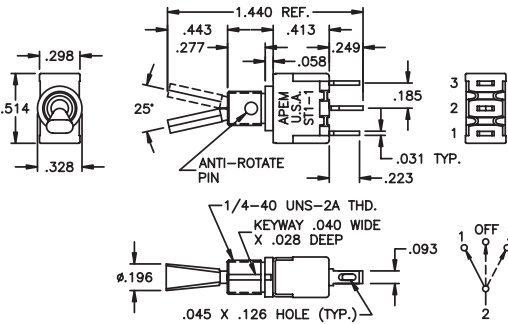

Terminal numbers for reference only

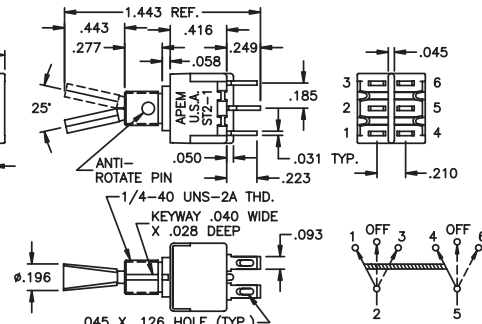

DOUBLE POLE

Splashproof bushing - panel mounting

An 'o'-ring placed internally between the actuator and the bushing, and a gasket placed externally between the bushing flange and mounting panel provides static protection from 3.3 ft. (1 meter) of water for 30 minutes.

SINGLE POLE



DOUBLE POLE



	POWER CKT. MODEL NO.	UL MODEL NO.				Key-way
Single pole	ST1-1KHZQ	UL11KHZQ	ON	NONE	ON	
	ST1-2KHZQ	UL12KHZQ	ON	OFF	ON	
	ST1-3KHZQ	UL13KHZQ	MOM	OFF	MOM	
	ST1-4KHZQ	UL14KHZQ	ON	OFF	MOM	
	ST1-5KHZQ	UL15KHZQ	ON	NONE	MOM	
Double pole	ST2-1KHZQ	UL21KHZQ	ON	NONE	ON	
	ST2-2KHZQ	UL22KHZQ	ON	OFF	ON	
	ST2-3KHZQ	UL23KHZQ	MOM	OFF	MOM	
	ST2-4KHZQ	UL24KHZQ	ON	OFF	MOM	
	ST2-5KHZQ	UL25KHZQ	ON	NONE	MOM	
	ST2-6KHZQ	UL26KHZQ	ON	ON	ON	
	ST2-7KHZQ	UL27KHZQ	ON	ON	MOM	
	ST2-8KHZQ	UL28KHZQ	MOM	ON	MOM	
Terminals connected (-6, -7 & -8)			1-2, 4-5	1-2, 5-6	2-3, 5-6	

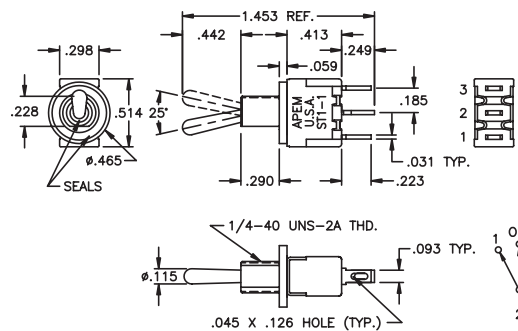

Terminal numbers for reference only

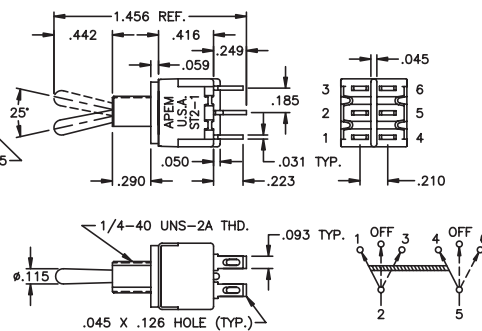

DOUBLE POLE

A

ST SERIES - MINIATURE TOGGLE SWITCHES

15/32" threaded bushing - panel mounting

SINGLE POLE WITH T1 ACTUATOR



DOUBLE POLE WITH T2 ACTUATOR



	POWER CKT. MODEL NO.	UL MODEL NO.				Key way
Single pole	ST1-1T1M4ZQ	UL11T1M4ZQ	ON	NONE	ON	
	ST1-2T1M4ZQ	UL12T1M4ZQ	ON	OFF	ON	
	ST1-3T1M4ZQ	UL13T1M4ZQ	MOM	OFF	MOM	
	ST1-4T1M4ZQ	UL14T1M4ZQ	ON	OFF	MOM	
	ST1-5T1M4ZQ	UL15T1M4ZQ	ON	NONE	MOM	
Double pole	ST2-1T1M4ZQ	UL21T1M4ZQ	ON	NONE	ON	
	ST2-2T1M4ZQ	UL22T1M4ZQ	ON	OFF	ON	
	ST2-3T1M4ZQ	UL23T1M4ZQ	MOM	OFF	MOM	
	ST2-4T1M4ZQ	UL24T1M4ZQ	ON	OFF	MOM	
	ST2-5T1M4ZQ	UL25T1M4ZQ	ON	NONE	MOM	
	ST2-6T1M4ZQ	UL26T1M4ZQ	ON	ON	ON	
	ST2-7T1M4ZQ	UL27T1M4ZQ	ON	ON	MOM	
	ST2-8T1M4ZQ	UL28T1M4ZQ	MOM	ON	MOM	
Terminals connected (-6, -7 & -8)			1-2, 4-5	1-2, 5-6	2-3, 5-6	

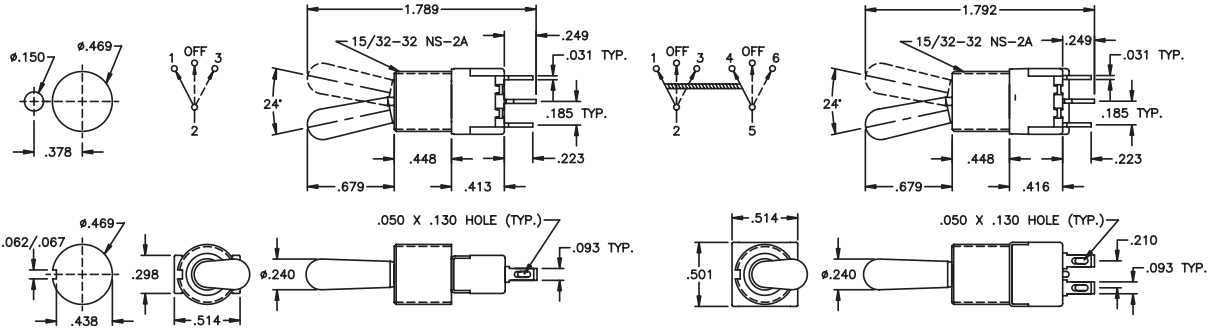

SINGLE POLE

Terminal numbers for reference only

DOUBLE POLE

Straight p.c. terminals with bracket - p.c. mounting

SINGLE POLE

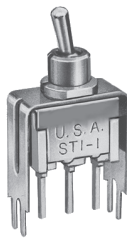

DOUBLE POLE

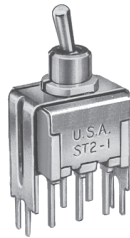

	DRY CKT. MODEL NO.	UL MODEL NO.				Key way
Single pole	ST1-1L3S3V30B	UL11L3S3V30Q	ON	NONE	ON	
	ST1-2L3S3V30B	UL12L3S3V30Q	ON	OFF	ON	
	ST1-3L3S3V30B	UL13L3S3V30Q	MOM	OFF	MOM	
	ST1-4L3S3V30B	UL14L3S3V30Q	ON	OFF	MOM	
	ST1-5L3S3V30B	UL15L3S3V30Q	ON	NONE	MOM	
Double pole	ST2-1L3S3V30B	UL21L3S3V30Q	ON	NONE	ON	
	ST2-2L3S3V30B	UL22L3S3V30Q	ON	OFF	ON	
	ST2-3L3S3V30B	UL23L3S3V30Q	MOM	OFF	MOM	
	ST2-4L3S3V30B	UL24L3S3V30Q	ON	OFF	MOM	
	ST2-5L3S3V30B	UL25L3S3V30Q	ON	NONE	MOM	
	ST2-6L3S3V30B	UL26L3S3V30Q	ON	ON	ON	
	ST2-7L3S3V30B	UL27L3S3V30Q	ON	ON	MOM	
	ST2-8L3S3V30B	UL28L3S3V30Q	MOM	ON	MOM	
Terminals connected (-6, -7 & -8)			1-2, 4-5	1-2, 5-6	2-3, 5-6	

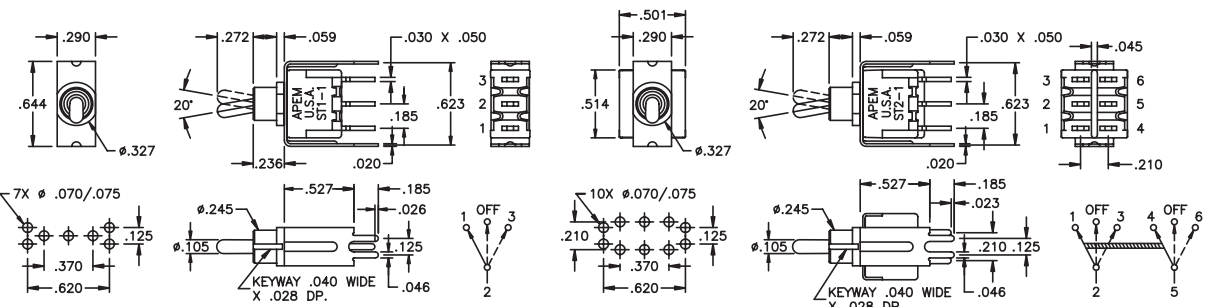

SINGLE POLE

Terminal numbers for reference only

DOUBLE POLE

SPECIFICATIONS SUBJECT TO CHANGE WITHOUT NOTICE

ST SERIES - MINIATURE TOGGLE SWITCHES

A

Horizontal right angle p.c. terminals - p.c. mounting

SINGLE POLE



DOUBLE POLE

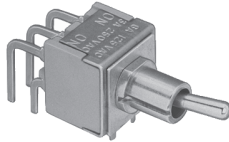

	DRY CKT. MODEL NO.	UL MODEL NO.			
Single pole	ST1-1L3S3AB	UL11L3S3AQ	ON	NONE	ON
	ST1-2L3S3AB	UL12L3S3AQ	ON	OFF	ON
	ST1-3L3S3AB	UL13L3S3AQ	MOM	OFF	MOM
	ST1-4L3S3AB	UL14L3S3AQ	ON	OFF	MOM
	ST1-5L3S3AB	UL15L3S3AQ	ON	NONE	MOM
Double pole	ST2-1L3S3AB	UL21L3S3AQ	ON	NONE	ON
	ST2-2L3S3AB	UL22L3S3AQ	ON	OFF	ON
	ST2-3L3S3AB	UL23L3S3AQ	MOM	OFF	MOM
	ST2-4L3S3AB	UL24L3S3AQ	ON	OFF	MOM
	ST2-5L3S3AB	UL25L3S3AQ	ON	NONE	MOM
	ST2-6L3S3AB	UL26L3S3AQ	ON	ON	ON
	ST2-7L3S3AB	UL27L3S3AQ	ON	ON	MOM
	ST2-8L3S3AB	UL28L3S3AQ	MOM	ON	MOM
Terminals connected (-6, -7 & -8)			1-2, 4-5	1-2, 5-6	2-3, 5-6

SPECIFICATIONS SUBJECT TO CHANGE WITHOUT NOTICE

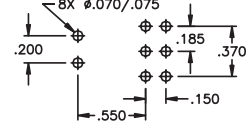
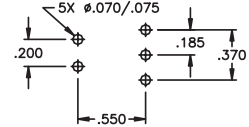
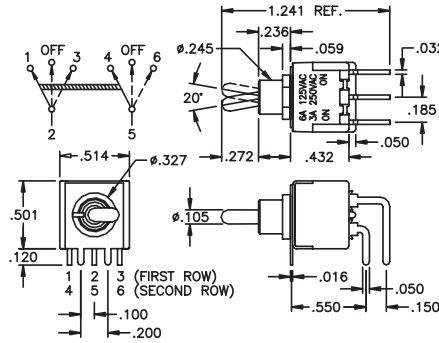
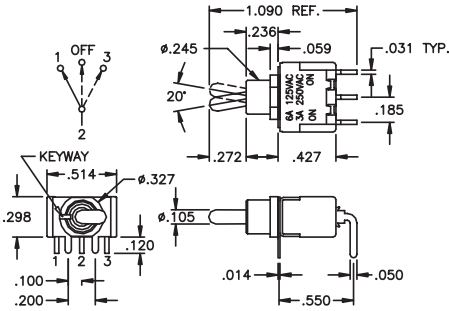

SINGLE POLE

DOUBLE POLE

Terminal numbers for reference only

Vertical right angle p.c. terminals - p.c. mounting

SINGLE POLE

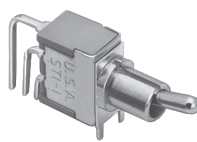

DOUBLE POLE

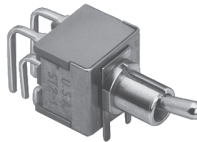

	DRY CKT. MODEL NO.	UL MODEL NO.			
Single pole	ST1-1L3S3V-1B	UL11L3S3V-1Q	ON	NONE	ON
	ST1-2L3S3V-1B	UL12L3S3V-1Q	ON	OFF	ON
	ST1-3L3S3V-1B	UL13L3S3V-1Q	MOM	OFF	MOM
	ST1-4L3S3V-1B	UL14L3S3V-1Q	ON	OFF	MOM
	ST1-5L3S3V-1B	UL15L3S3V-1Q	ON	NONE	MOM
Double pole	ST2-1L3S3V-1B	UL21L3S3V-1Q	ON	NONE	ON
	ST2-2L3S3V-1B	UL22L3S3V-1Q	ON	OFF	ON
	ST2-3L3S3V-1B	UL23L3S3V-1Q	MOM	OFF	MOM
	ST2-4L3S3V-1B	UL24L3S3V-1Q	ON	OFF	MOM
	ST2-5L3S3V-1B	UL25L3S3V-1Q	ON	NONE	MOM
	ST2-6L3S3V-1B	UL26L3S3V-1Q	ON	ON	ON
	ST2-7L3S3V-1B	UL27L3S3V-1Q	ON	ON	MOM
	ST2-8L3S3V-1B	UL28L3S3V-1Q	MOM	ON	MOM
Terminals connected (-6, -7 & -8)			1-2, 4-5	1-2, 5-6	2-3, 5-6

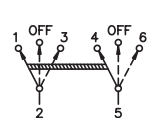
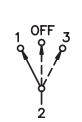
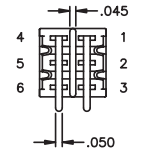
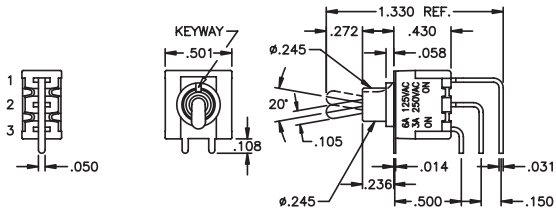
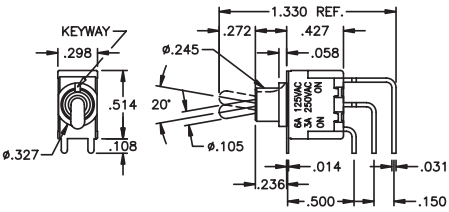

SINGLE POLE

DOUBLE POLE

Terminal numbers for reference only

A

ST SERIES - MINIATURE TOGGLE SWITCHES

Snap-in bezel with outboard LED

PATENT NO.
Des. 282,524

UL11KMZQJ6128

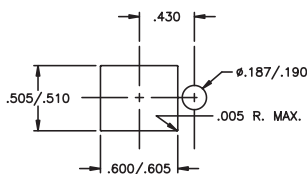
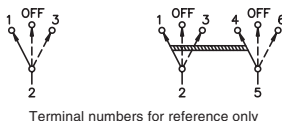
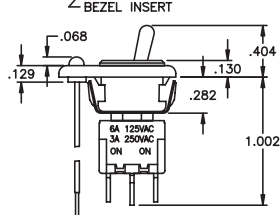
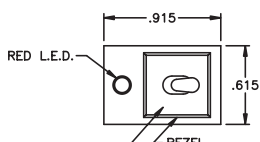
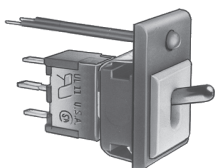

Panel thickness range .047" to .125".

	POWER CKT. MODEL NO.	UL MODEL NO.	USA marking on opposite side		
			ON	NONE	ON
Single pole	ST1-1KMZQJ6122	UL11KMZQJ6122	ON	NONE	ON
	ST1-2KMZQJ6122	UL12KMZQJ6122	ON	OFF	ON
	ST1-3KMZQJ6122	UL13KMZQJ6122	MOM	OFF	MOM
	ST1-4KMZQJ6122	UL14KMZQJ6122	ON	OFF	MOM
	ST1-5KMZQJ6122	UL15KMZQJ6122	ON	NONE	MOM
Double pole	ST2-1KMZQJ6122	UL21KMZQJ6122	ON	NONE	ON
	ST2-2KMZQJ6122	UL22KMZQJ6122	ON	OFF	ON
	ST2-3KMZQJ6122	UL23KMZQJ6122	MOM	OFF	MOM
	ST2-4KMZQJ6122	UL24KMZQJ6122	ON	OFF	MOM
	ST2-5KMZQJ6122	UL25KMZQJ6122	ON	NONE	MOM
	ST2-6KMZQJ6122	UL26KMZQJ6122	ON	ON	ON
	ST2-7KMZQJ6122	UL27KMZQJ6122	ON	ON	MOM
	ST2-8KMZQJ6122	UL28KMZQJ6122	MOM	ON	MOM
Terminals connected (-6, -7 & -8)			1-2,	1-2,	2-3,
			4-5	5-6	5-6

Above models have black bezel and insert.

Snap-in bezel with 0, 1 or 2 inboard LEDs

PATENT NO.
Des. 282,524

ST1-1KMZQJ9128

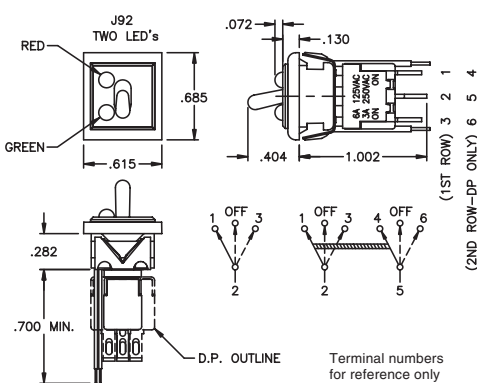
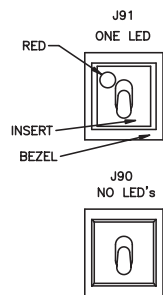
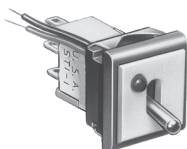

	POWER CKT. MODEL NO.	UL MODEL NO.	USA marking on opposite side		
			ON	NONE	ON
Single pole	ST1-1KMZQJ9122	UL11KMZQJ9122	ON	NONE	ON
	ST1-2KMZQJ9122	UL12KMZQJ9122	ON	OFF	ON
	ST1-3KMZQJ9122	UL13KMZQJ9122	MOM	OFF	MOM
	ST1-4KMZQJ9122	UL14KMZQJ9122	ON	OFF	MOM
	ST1-5KMZQJ9122	UL15KMZQJ9122	ON	NONE	MOM
Double pole	ST2-1KMZQJ9122	UL21KMZQJ9122	ON	NONE	ON
	ST2-2KMZQJ9122	UL22KMZQJ9122	ON	OFF	ON
	ST2-3KMZQJ9122	UL23KMZQJ9122	MOM	OFF	MOM
	ST2-4KMZQJ9122	UL24KMZQJ9122	ON	OFF	MOM
	ST2-5KMZQJ9122	UL25KMZQJ9122	ON	NONE	MOM
	ST2-6KMZQJ9122	UL26KMZQJ9122	ON	ON	ON
	ST2-7KMZQJ9122	UL27KMZQJ9122	ON	ON	MOM
	ST2-8KMZQJ9122	UL28KMZQJ9122	MOM	ON	MOM
Terminals connected (-6, -7 & -8)			1-2,	1-2,	2-3,
			4-5	5-6	5-6

Above models have black bezel and insert.

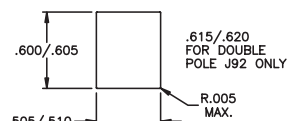

FOR MULTIPLE SWITCH ASSEMBLIES, THIS DIMENSION=(NO. OF SWITCHES X .615)-.120
PANEL THICKNESS RANGE: .047-.125

SPECIFICATIONS SUBJECT TO CHANGE WITHOUT NOTICE

ST SERIES - MINIATURE TOGGLE SWITCHES

A

Bezel for p.c. mounted switches with 0, 1 or 2 LEDs

PATENT NO.
Des. 282,524

ST1-1KMCBJ9488

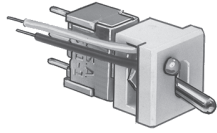

		DRY CKT. MODEL NO.	UL MODEL NO.	USA marking on opposite side		
Single pole	ST1-1KMCBJ9422	UL11KMCQJ9422	ON	NONE	ON	
	ST1-2KMCBJ9422	UL12KMCQJ9422	ON	OFF	ON	
	ST1-3KMCBJ9422	UL13KMCQJ9422	MOM	OFF	MOM	
	ST1-4KMCBJ9422	UL14KMCQJ9422	ON	OFF	MOM	
	ST1-5KMCBJ9422	UL15KMCQJ9422	ON	NONE	MOM	
Double pole	ST2-1KMCBJ9422	UL21KMCQJ9422	ON	NONE	ON	
	ST2-2KMCBJ9422	UL22KMCQJ9422	ON	OFF	ON	
	ST2-3KMCBJ9422	UL23KMCQJ9422	MOM	OFF	MOM	
	ST2-4KMCBJ9422	UL24KMCQJ9422	ON	OFF	MOM	
	ST2-5KMCBJ9422	UL25KMCQJ9422	ON	NONE	MOM	
	ST2-6KMCBJ9422	UL26KMCQJ9422	ON	ON	ON	
	ST2-7KMCBJ9422	UL27KMCQJ9422	ON	ON	MOM	
ST2-8KMCBJ9422	UL28KMCQJ9422	MOM	ON	MOM		
Terminals connected (-6, -7 & -8)				1-2,	1-2,	2-3,
				4-5	5-6	5-6

Above models have black bezel and insert.

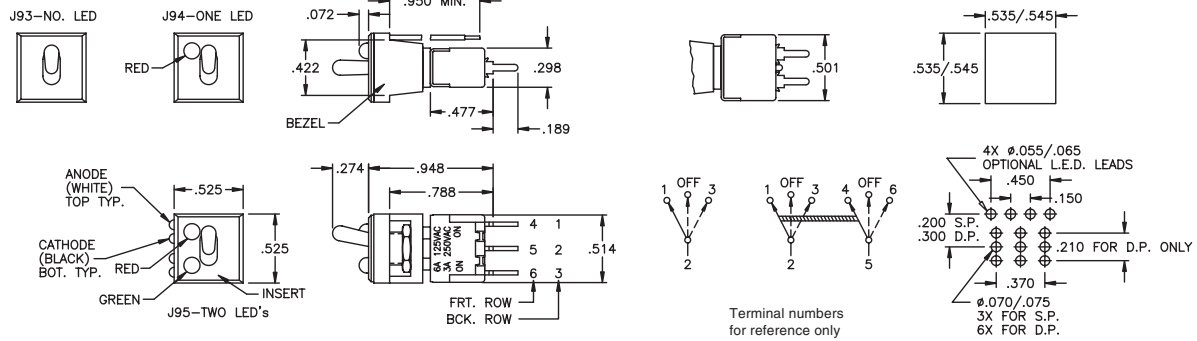

Bezel for p.c. mounted switches with 0, 1 or 2 LEDs

PATENT NO.
Des. 282,524

ST1-1KMV30QJ9488

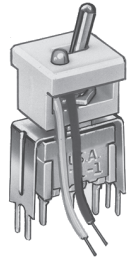

		DRY CKT. MODEL NO.	UL MODEL NO.	USA marking on opposite side		
Single pole	ST1-1KMV30BJ9422	UL11KMV30QJ9422	ON	NONE	ON	
	ST1-2KMV30BJ9422	UL12KMV30QJ9422	ON	OFF	ON	
	ST1-3KMV30BJ9422	UL13KMV30QJ9422	MOM	OFF	MOM	
	ST1-4KMV30BJ9422	UL14KMV30QJ9422	ON	OFF	MOM	
	ST1-5KMV30BJ9422	UL15KMV30QJ9422	ON	NONE	MOM	
Double pole	ST2-1KMV30BJ9422	UL21KMV30QJ9422	ON	NONE	ON	
	ST2-2KMV30BJ9422	UL22KMV30QJ9422	ON	OFF	ON	
	ST2-3KMV30BJ9422	UL23KMV30QJ9422	MOM	OFF	MOM	
	ST2-4KMV30BJ9422	UL24KMV30QJ9422	ON	OFF	MOM	
	ST2-5KMV30BJ9422	UL25KMV30QJ9422	ON	NONE	MOM	
	ST2-6KMV30BJ9422	UL26KMV30QJ9422	ON	ON	ON	
	ST2-7KMV30BJ9422	UL27KMV30QJ9422	ON	ON	MOM	
ST2-8KMV30BJ9422	UL28KMV30QJ9422	MOM	ON	MOM		
Terminals connected (-6, -7 & -8)				1-2,	1-2,	2-3,
				4-5	5-6	5-6

Above models have black bezel and insert.

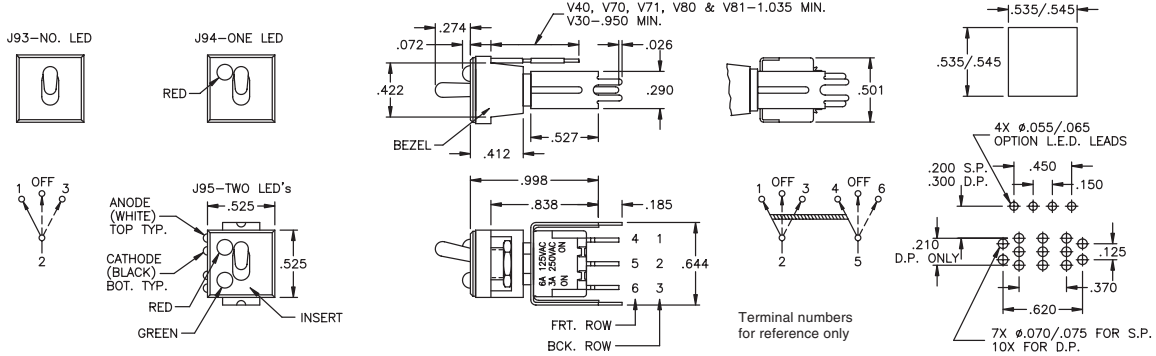

ST SERIES - MINIATURE TOGGLE SWITCHES

Bezel for right angle p.c. mtd. switches with 0, 1 or 2 LEDs

PATENT NO.
Des. 282,524

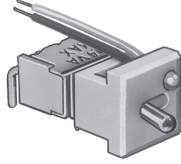

ST1-1KMA-1BJ9488

Poles	Option	Dim. A	Dim. B
SP	A	.148	.045 max.
SP	A-1	.164	.095 max.
DP	A	.250	.300 max.
DP	A-1	.266	.350 max.

	DRY CKT. MODEL NO.		UL MODEL NO.		USA marking on opposite side		
	Single pole	Double pole	ON	NONE	ON	OFF	MOM
ST1-1KMA-1BJ9422	UL11KMA-1QJ9422	ON	NONE	ON			
ST1-2KMA-1BJ9422	UL12KMA-1QJ9422	ON	OFF	ON			
ST1-3KMA-1BJ9422	UL13KMA-1QJ9422	MOM	OFF	MOM			
ST1-4KMA-1BJ9422	UL14KMA-1QJ9422	ON	OFF	MOM			
ST1-5KMA-1BJ9422	UL15KMA-1QJ9422	ON	NONE	MOM			
ST2-1KMA-1BJ9422	UL21KMA-1QJ9422	ON	NONE	ON			
ST2-2KMA-1BJ9422	UL22KMA-1QJ9422	ON	OFF	ON			
ST2-3KMA-1BJ9422	UL23KMA-1QJ9422	MOM	OFF	MOM			
ST2-4KMA-1BJ9422	UL24KMA-1QJ9422	ON	OFF	MOM			
ST2-5KMA-1BJ9422	UL25KMA-1QJ9422	ON	NONE	MOM			
ST2-6KMA-1BJ9422	UL26KMA-1QJ9422	ON	ON	ON			
ST2-7KMA-1BJ9422	UL27KMA-1QJ9422	ON	ON	MOM			
ST2-8KMA-1BJ9422	UL28KMA-1QJ9422	MOM	ON	MOM			
Terminals connected (-6, -7 & -8)					1-2, 4-5	1-2, 5-6	2-3, 5-6

Above models have black bezel and insert.

J93-NO. LED



J94-ONE LED

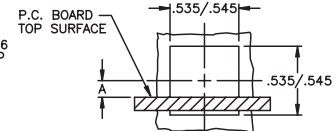
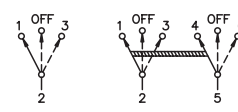
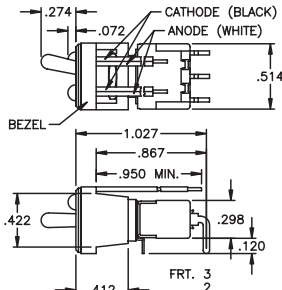
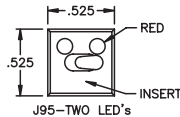
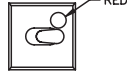

Terminal numbers for reference only

B MAX. TO BOARD EDGE

Bezel for right angle p.c. mtd. switches with 0, 1 or 2 LEDs

PATENT NO.
Des. 282,524

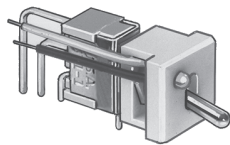

ST1-1KMV-1BJ9488

Poles	Option	Dim. A	Dim. B
SP	A	.148	.045 max.
SP	A-1	.164	.095 max.
DP	A	.250	.300 max.
DP	A-1	.266	.350 max.

	DRY CKT. MODEL NO.		UL MODEL NO.		USA marking on opposite side		
	Single pole	Double pole	ON	NONE	ON	OFF	MOM
ST1-1KMV-1BJ9422	UL11KMV-1QJ9422	ON	NONE	ON			
ST1-2KMV-1BJ9422	UL12KMV-1QJ9422	ON	OFF	ON			
ST1-3KMV-1BJ9422	UL13KMV-1QJ9422	MOM	OFF	MOM			
ST1-4KMV-1BJ9422	UL14KMV-1QJ9422	ON	OFF	MOM			
ST1-5KMV-1BJ9422	UL15KMV-1QJ9422	ON	NONE	MOM			
ST2-1KMV-1BJ9422	UL21KMV-1QJ9422	ON	NONE	ON			
ST2-2KMV-1BJ9422	UL22KMV-1QJ9422	ON	OFF	ON			
ST2-3KMV-1BJ9422	UL23KMV-1QJ9422	MOM	OFF	MOM			
ST2-4KMV-1BJ9422	UL24KMV-1QJ9422	ON	OFF	MOM			
ST2-5KMV-1BJ9422	UL25KMV-1QJ9422	ON	NONE	MOM			
ST2-6KMV-1BJ9422	UL26KMV-1QJ9422	ON	ON	ON			
ST2-7KMV-1BJ9422	UL27KMV-1QJ9422	ON	ON	MOM			
ST2-8KMV-1BJ9422	UL28KMV-1QJ9422	MOM	ON	MOM			
Terminals connected (-6, -7 & -8)					1-2, 4-5	1-2, 5-6	2-3, 5-6

Above models have black bezel and insert.

J93-NO. LED



J94-ONE LED

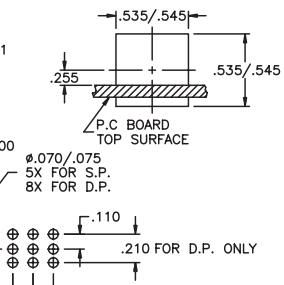
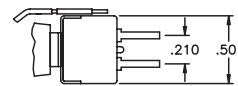
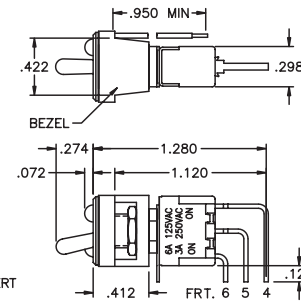
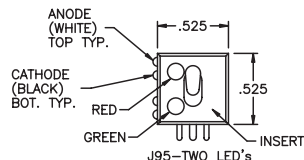

Terminal numbers for reference only

ST SERIES - MINIATURE TOGGLE SWITCHES

A

Snap-in bezel for round hole mounting with 0, 1 or 2 LEDs
Self keying against rotation

PATENT NO.
Des. 282,524

ST1-1KMZQJ9788

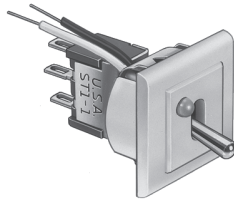

	POWER CKT. MODEL NO.	UL MODEL NO.	USA marking on opposite side		
Single pole	ST1-1KMZQJ9722	UL11KMZQJ9722	ON	NONE	ON
	ST1-2KMZQJ9722	UL12KMZQJ9722	ON	OFF	ON
	ST1-3KMZQJ9722	UL13KMZQJ9722	MOM	OFF	MOM
	ST1-4KMZQJ9722	UL14KMZQJ9722	ON	OFF	MOM
	ST1-5KMZQJ9722	UL15KMZQJ9722	ON	NONE	MOM
Double pole	ST2-1KMZQJ9722	UL21KMZQJ9722	ON	NONE	ON
	ST2-2KMZQJ9722	UL22KMZQJ9722	ON	OFF	ON
	ST2-3KMZQJ9722	UL23KMZQJ9722	MOM	OFF	MOM
	ST2-4KMZQJ9722	UL24KMZQJ9722	ON	OFF	MOM
	ST2-5KMZQJ9722	UL25KMZQJ9722	ON	NONE	MOM
	ST2-6KMZQJ9722	UL26KMZQJ9722	ON	ON	ON
	ST2-7KMZQJ9722	UL27KMZQJ9722	ON	ON	MOM
	ST2-8KMZQJ9722	UL28KMZQJ9722	MOM	ON	MOM
Terminals connected (-6, -7 & -8)			1-2,	1-2,	2-3,
			4-5	5-6	5-6

SPECIFICATIONS SUBJECT TO CHANGE WITHOUT NOTICE

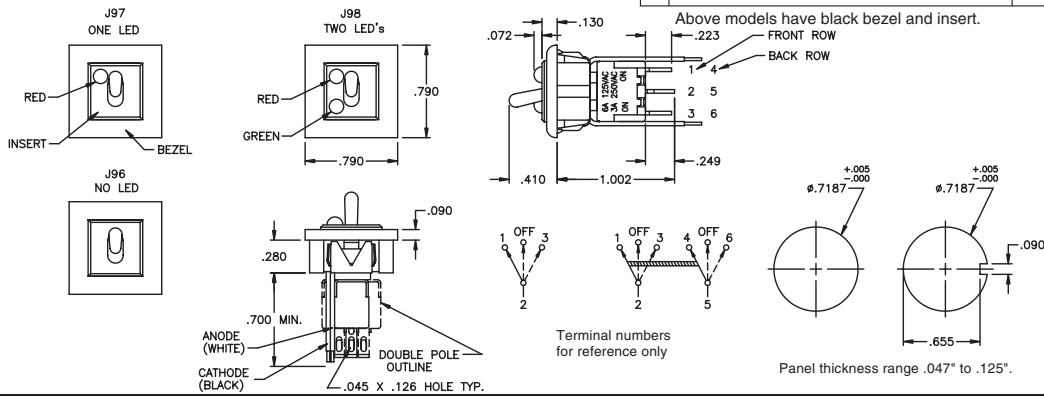

MISCELLANEOUS

ST2-6, -7 & -8 SWITCHES

May be wired as a single pole 3 position switch; add external jumper between terminals 1 & 5, then -

Common terminal is 2
Output 1 - terminal 4
Output 2 - terminal 6
Output 3 - terminal 3

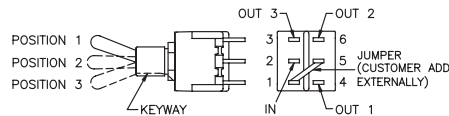

HARDWARE SUPPLIED

(See Hardware section of catalog)

Switches with M and Y option bushings are supplied with (2) A112 Hex Nuts, (1) A115 Lockwasher and (1) A107 Anti-rotate Ring.

Switches with D bushings are supplied with (2) A112 Hex Nuts and (1) A115 Lockwasher.

Switches with H option bushing are supplied with (1) A112 Hex Nut, (1) A115 Lockwasher and (1) A257 Gasket.

Switches with M4 and M5 bushings are supplied with (2) A465 Hex Nuts, (1) A466 Lockwasher and (1) A482 Anti-rotate Ring.

Note: Switches with non-threaded bushings or bezels supplied without hardware.

QUICK-CONNECT RECEPTACLES that are compatible with solder lug or p.c. terminals are commercially available - consult factory.

FRONT PANEL SEAL: Silicone rubber boots for front panel sealing of the switch against high pressure water or other contaminants are available - see Waterproof switch sealing boots section of catalog.

TYPICAL SWITCH CROSS SECTIONS

Note:
Contacts make opposite actuator direction.

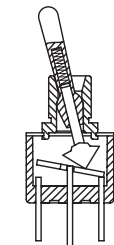

ON NONE ON

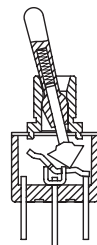

ON OFF ON



MOM OFF MOM



ON OFF MOM



ON NONE MOM

ST SERIES - MINIATURE TOGGLE SWITCHES

Additional ordering information: Commonly ordered models are shown on prior pages with complete model numbers and specifications. Below is an order format that enables you to 'build your own switch' and specify the correct switch model number by simply selecting from all available options shown and filling in the boxes.

'BUILD YOUR OWN SWITCH' ORDER FORMAT

Fill in boxes with selections shown for **Model Structure**, then add **Options** selections for complete model number. Allowable options are shown below each respective box with brief description - see option dwgs. & info. following. Note: 'NONE' indicates box may be left empty.

Model Structure:

Series	Electrical functions	Actuators	Bushings	Terminations	Contact material
Single pole: S T 1 -	1 ON NONE ON 2 ON OFF ON	K Standard bat F 1 Flatted	M Standard 1/4" thd'd. D 'D' flat 1/4" thd'd.	Z Solder lug C Printed circuit	B Gold Q Coin silver
S.P. UL model: U L 1	3 MOM OFF MOM 4 ON OFF MOM	F 2 Long flatted F 3 Short flatted	H Splashproof 1/4" thd'd. Y Long 1/4" thd'd.	W Wirewrap W 1 Lg. wirewrap	G Gold/coin silver
Double pole: S T 2 -	5 ON - MOM Following for DP only	L Long round L 1 Medium rnd.	S 2 Non-threaded S 3 Short non-thd'd.	W 3 Sht. wirewrap X Extra lg. wirewrap	N Economy gold
D.P. UL model: U L 2	6 ON ON ON 7 ON ON MOM 8 MOM ON MOM	L 2 Short round L 3 Short round Following for M4 & M5 bushings only	M 4 15/32" thd'd. M 5 M4 with 'o'-ring	Horiz. right angle p.c. terminals: A A - 1 Vertical right angle p.c. terminals: V V - 1 V - 2	T Economy silver
<p>Note: When switch is ordered with a bezel, actuator selection may be K, L, L1, or L2 and bushing must be M only.</p>					
<p>Straight p.c. terminals w/brkt.:</p> <p>V 3 0 V 3 1 V 4 0 V 4 1 V 7 0 V 8 0 V 7 1 V 8 1</p>					

Options:

Sealing	Colored actuator*	Colored bushing*	Bezel & Insert	Bezel color	Insert color	Approvals
(NONE) E Epoxy	(NONE) 2 Black	(NONE) 2 Black	(NONE) J 6 1 Snap-in w/LED J 9 0 Snap-in no LED J 9 1 Snap-in w/LED J 9 2 Snap-in w/2 LEDs J 9 3 p.c. no LED J 9 4 p.c. w/LED J 9 5 p.c. w/2 LEDs	(NONE) 2 Black 6 Red 8 White	(NONE) 2 Black 6 Red 8 White	(NONE) / C S A
<p>* colored actuator and bushing applicable to non-bezel models only</p>			<p>Self-keying round hole mt.:</p> <p>J 9 6 Snap-in no LED J 9 7 Snap-in w/LED J 9 8 Snap-in w/2 LEDs</p>			<p>Example of completely specified model number: UL15KMZQEJ9726/CSA</p>

**SWITCH BODY
SIZES WITH
TERMINAL
LOCATION
DIMENSIONS**

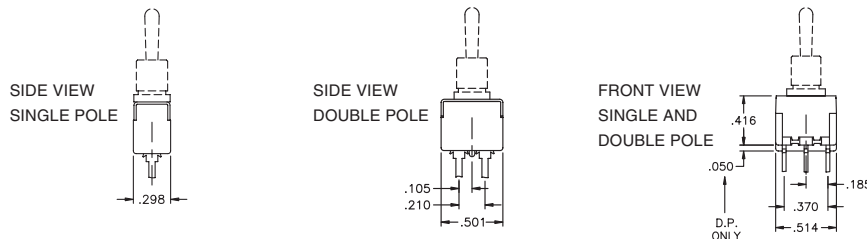

ST SERIES - MINIATURE TOGGLE SWITCHES

A

SPECIFICATIONS SUBJECT TO CHANGE WITHOUT NOTICE

ACTUATOR OPTIONS

<p>L</p> <p>LONG ROUND</p>	<p>F1</p> <p>FLATTED</p>	<p>F2</p> <p>LONG FLATTED</p>	<p>F3</p> <p>SHORT FLATTED</p>	<p>K (STANDARD)</p> <p>ROUND</p>
<p>L1</p> <p>MEDIUM ROUND</p>	<p>L2</p> <p>SHORT ROUND</p>	<p>L3</p> <p>SHORT ROUND</p>	<p>T1 & T2 (FOR M4 & M5 BUSHINGS ONLY)</p> <p>LONG & SHORT ROUND</p>	<p>T3 & T4</p> <p>Same as T1 & T2 respectively except with positive internal keying and sideways support to provide more ruggedness in harsh applications.</p> <p>Available only with M4 bushing</p>

BUSHING OPTIONS

<p>D</p> <p>THREADED</p>	<p>H</p> <p>SPLASHPROOF</p>	<p>SEALS</p>	<p>M (STANDARD)</p> <p>THREADED</p>	<p>Y</p> <p>LONG THREADED</p>
<p>S2</p> <p>NON THREADED</p>	<p>S3</p> <p>NON THREADED</p>	<p>M4 & M5</p> <p>THREADED</p>	<p>M5 FEATURES 'O' RING FOR SPLASHPROOF APPLICATIONS</p> <p>'O' RING</p>	

ACTUATOR & BUSHING COMPATIBILITY TABLE WITH DIMENSIONS FOR SELECTIONS

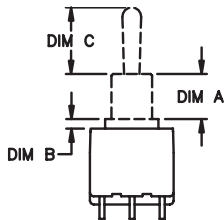

Bushing Option	Bushing Dims.		Actuator length dimension C									
	Dim A	Dim B	F1	F2	F3	K	L	L1	L2	L3	T1	T2
D	.277	.060	N/A	N/A	N/A	.410	.840	.640	.270	.170	N/A	N/A
H	.290	.060	N/A	N/A	N/A	.410	.840	.640	.270	.170	N/A	N/A
M	.277	.060	.450	.650	.250	.410	.840	.640	.270	.170	N/A	N/A
Y	.330	.040	N/A	N/A	N/A	.410	.840	.640	.270	.170	N/A	N/A
S2	.277	.060	.450	.650	.250	.410	.840	.640	.270	.170	N/A	N/A
S3	.177	.060	N/A	N/A	N/A	.510	.940	.740	.370	.270	N/A	N/A
M4	.448	-	N/A	N/A	N/A	N/A	N/A	N/A	N/A	N/A	.460	.687
M5	.448	-	N/A	N/A	N/A	N/A	N/A	N/A	N/A	N/A	.460	.687

N/A - NOT AVAILABLE

CONSULT FACTORY FOR SPECIAL REQUIREMENTS

ST SERIES - MINIATURE TOGGLE SWITCHES

TERMINATION OPTIONS

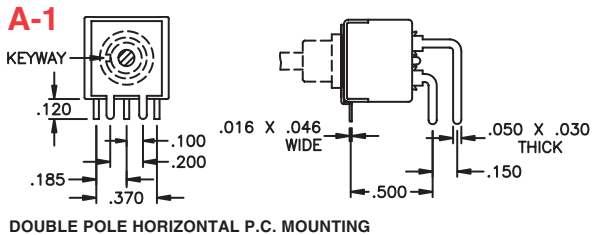
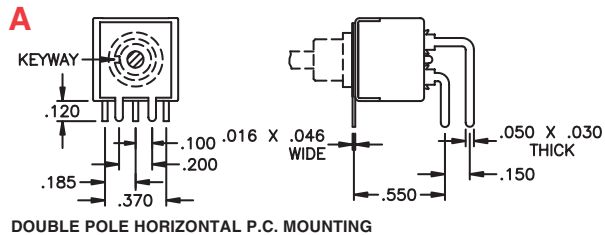
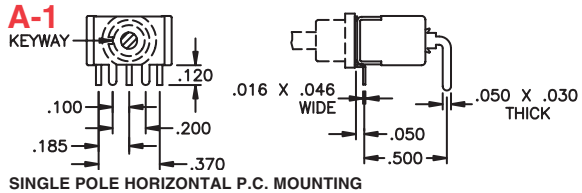
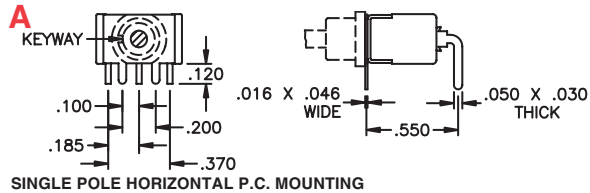

V, V-1 & V-2

Option	Dim. A	Dim. B
V	.550	.150
V-1	.500	.150
V-2	.500	.100

VERTICAL P.C. MOUNTING

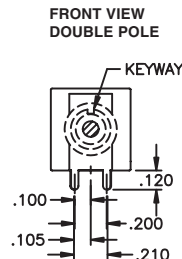
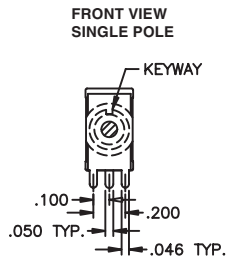

SIDE VIEW - SINGLE & DOUBLE POLE

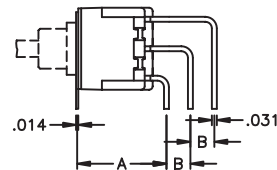

V30, V40, V70, V80, V31, V41, V71 & V81

PANEL LAYOUT V30, V31, V40 & V41

Option	Dim. A	Dim. B
V30-V31	.527	.024
V40-V41	.647	.048

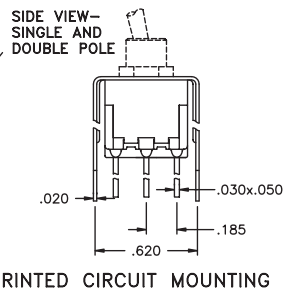
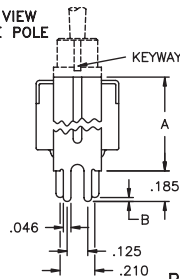
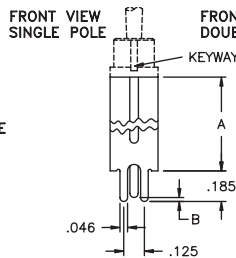
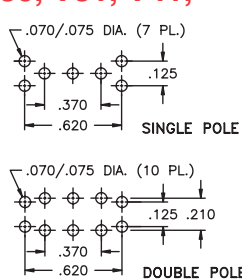

PANEL LAYOUT V70, V71, V80 & V81

Option	Dim. A
V70-V71	.630
V80-V81	.953

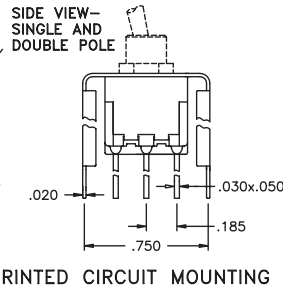
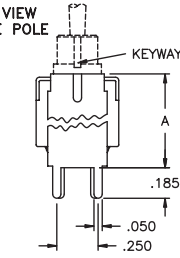
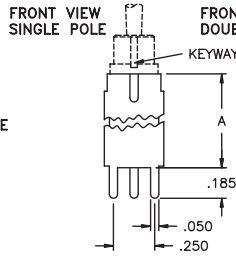
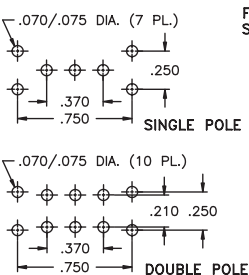

V31, V41, V71 & V81 ARE THE SAME AS V30, V40, V70 & V80 RESPECTIVELY, EXCEPT WITH CRIMPED LEG DESIGN FOR P.C. BOARD RETENTION, AS SHOWN TO RIGHT.

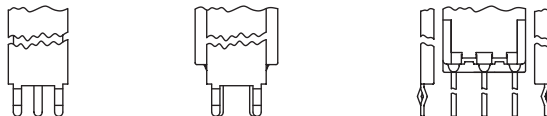

SPECIFICATIONS SUBJECT TO CHANGE WITHOUT NOTICE

ST SERIES - MINIATURE TOGGLE SWITCHES

A

SPECIFICATIONS SUBJECT TO CHANGE WITHOUT NOTICE

TERMINATION OPTIONS (CONT'D.)

<p>Z</p> <p>SOLDER LUG</p>	<p>C</p> <p>PRINTED CIRCUIT</p>	<p>W</p> <p>WIREWRAP</p>	<p>W1</p> <p>LONG WIREWRAP</p>	<p>W3</p> <p>SHORT WIREWRAP</p>	<p>X</p> <p>EXTRA LG. WIREWRAP</p>
--	---	--	--	---	--

CONTACT MATERIAL OPTIONS

- B** Dry circuit - gold over nickel over brass.
RATING: 0.4 Volt-Amps (VA) max. at 20 V max.
ELECTRIC LIFE: 100,000 cycles min. (ST1-1 & ST2-1 only - other models 40,000 cycles min.)
- Q** Power circuit - coin silver.
RATING: 6 Amps at 125 VAC, 3 Amps at 250 VAC or 7 Amps at 30 VDC (resistive loads).
ELECTRIC LIFE: 100,000 cycles min. (ST1-1 & ST2-1 only - other models 40,000 cycles min.)
- G** Dry circuit or power circuit - gold over nickel over coin silver.
RATINGS & ELECTRIC LIFE: Same as B & Q above - i.e. - can be used in either dry circuit or power circuit, however once used in power circuit, switch cannot be re-used in dry circuit. This option satisfies those customers who have both dry circuit and power circuit requirements, but prefer to inventory only one switch for both.
- N** Dry circuit - gold over nickel over brass. Note- less gold than B option.
RATING: 0.4 Volt-Amps (VA) max. at 20 V max.
ELECTRIC LIFE: 10,000 cycles min. at 13 cycles per minute.
- T** Power circuit - Silver plate over brass.
RATING: 3 Amps at 125 VAC or 1.5 Amps at 250 VAC (resistive loads).
ELECTRIC LIFE: 10,000 cycles min. at 13 cycles per minute.

Solder dipped terminals and custom contact plating available - contact factory.

UL & CSA OPTIONS

- UL** For power circuits - coin silver
RATING: 6 Amps at 125 VAC or 3 Amps at 250 VAC (75% power factor).
Underwriter Laboratories file no. E66367. To specify, order UL model no. Note - applicable only to terminations with coin silver contacts (Q or G options).
- CSA** For power circuits - coin silver
RATING: 6 Amps at 125 VAC or 3 Amps at 250 VAC (75% power factor). Canadian Standards Association file no. LR54592-1. To specify, UL model number, then add '/CSA' to complete switch number. Note - applicable only to terminations with coin silver contacts (Q or G options) as CSA recognizes switches for power applications only.

SEALING & MISCELLANEOUS OPTIONS

- E** Epoxy terminal sealing: Available with all terminal configurations.
The space between terminal & case hole is sealed with epoxy all around terminal.
Provides maximum protection from entry of flux or contaminants into the switch case.

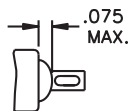

- /R** To specify reverse switch action on non-symmetrical models with bushing keyway, add '/R' to switch model no.

- 22** Black finish is available on actuator, bushing & hardware. To specify, add '-22' to switch model no.

A

ST SERIES - MINIATURE TOGGLE SWITCHES

PANEL CUT-OUTS

Cut-outs that accept all 1/4-40 threaded bushings:

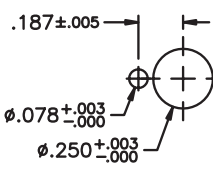
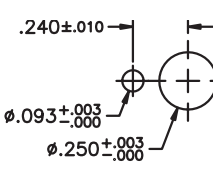
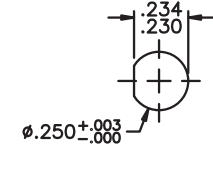
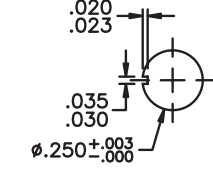
 <p>Without keying</p>	 <p>With A107 anti-rotate ring</p>	 <p>With A158 anti-rotate ring</p>	 <p>With D bushing</p>	 <p>With slotted keyway bushings</p>
---	---	---	--	---

Cut-outs that accept non-threaded 1/4" bushings and 15/32" threaded bushings:

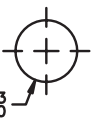
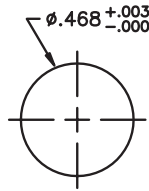
 <p>Accepts all non-threaded 1/4" bushings</p>	 <p>15/32" threaded bushings</p>
---	---

SPECIFICATIONS SUBJECT TO CHANGE WITHOUT NOTICE