

Previous Datasheet

前のデータシート

Index

目次

Next Data Sheet

次のデータシート



DISCRETE POWER DIODES and THYRISTORS
DATA BOOK

D-460

To Order

ご注文



Bulletin I25179/B

International
IOR Rectifier

ST183S SERIES

INVERTER GRADE THYRISTORS

Stud Version

Features

- All diffused design
- Center amplifying gate
- Guaranteed high dv/dt
- Guaranteed high di/dt
- High surge current capability
- Low thermal impedance
- High speed performance

195A

Typical Applications

- Inverters
- Choppers
- Induction heating
- All types of force-commutated converters

Major Ratings and Characteristics

Parameters	ST183S	Units
$I_{T(AV)}$	195	A
	@ T_C	85 °C
$I_{T(RMS)}$	306	A
I_{TSM}	@ 50Hz	4900 A
	@ 60Hz	5130 A
I^2t	@ 50Hz	120 KA ² s
	@ 60Hz	110 KA ² s
V_{DRM}/V_{RRM}	400 to 800	V
t_q range	10 to 20	μs
T_J	- 40 to 125	°C

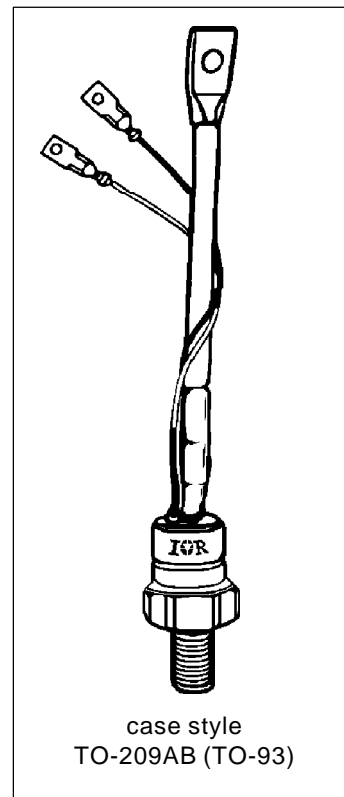

D-461

To Order
ご注文



ST183S Series

ELECTRICAL SPECIFICATIONS

Voltage Ratings

Type number	Voltage Code	V_{DRM}/V_{RRM} , maximum repetitive peak voltage V	V_{RSM} , maximum non-repetitive peak voltage V	I_{DRM}/I_{RRM} max. @ $T_J = T_J$ max. mA
ST183S	04	400	500	40
	08	800	900	

Current Carrying Capability

Frequency							Units
	I_{TM}	I_{TM}	I_{TM}	I_{TM}	I_{TM}	I_{TM}	
50Hz	570	370	900	610	7040	5220	A
400Hz	560	360	940	630	3200	2280	
1000Hz	500	300	925	610	1780	1200	
2500Hz	340	190	760	490	880	560	
Recovery voltage Vr	50	50	50	50	50	50	V
Voltage before turn-on Vd	V_{DRM}		V_{DRM}		V_{DRM}		
Rise of on-state current di/dt	50	50	-	-	-	-	A/µs
Case temperature	60	85	60	85	60	85	°C
Equivalent values for RC circuit	47Ω / 0.22µF		47Ω / 0.22µF		47Ω / 0.22µF		

On-state Conduction

Parameter	ST183S	Units	Conditions		
$I_{T(AV)}$ Max. average on-state current @ Case temperature	195	A	180° conduction, half sine wave		
	85	°C			
$I_{T(RMS)}$ Max. RMS on-state current	306	A	DC @ 74°C case temperature		
I_{TSM} Max. peak, one half cycle, non-repetitive surge current	4900		t = 10ms	No voltage	Sinusoidal half wave, Initial $T_J = T_J$ max
	5130		t = 8.3ms	reapplied	
	4120		t = 10ms	100% V_{RRM}	
	4310	t = 8.3ms	reapplied		
I^2t Maximum I^2t for fusing	120	KA ² s	t = 10ms	No voltage	Initial $T_J = T_J$ max
	110		t = 8.3ms	reapplied	
	85		t = 10ms	100% V_{RRM}	
	78		t = 8.3ms	reapplied	
$I^2\sqrt{t}$ Maximum $I^2\sqrt{t}$ for fusing	1200	KA ² /s	t = 0.1 to 10ms, no voltage reapplied		



ST183S Series

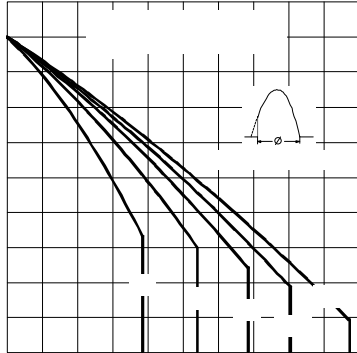

Fig. 1 - Current Ratings Characteristics

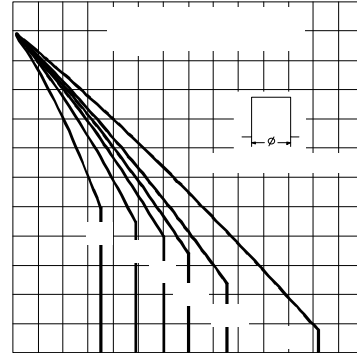

Fig. 2 - Current Ratings Characteristics

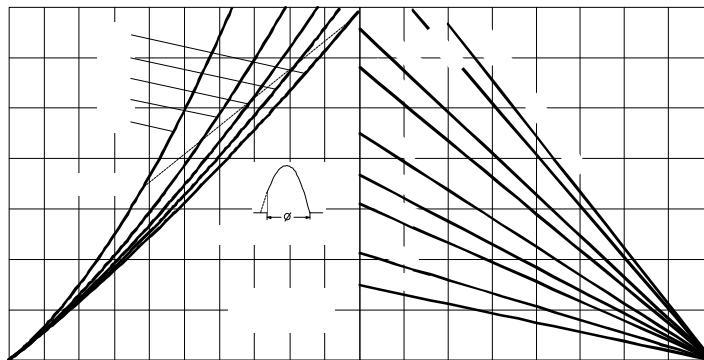

Fig. 3 - On-state Power Loss Characteristics

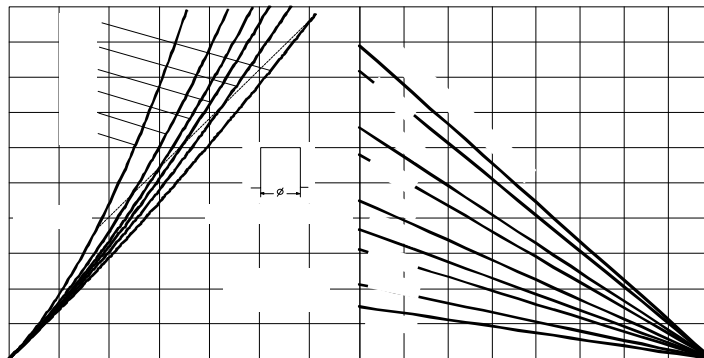

Fig. 4 - On-state Power Loss Characteristics



ST183S Series

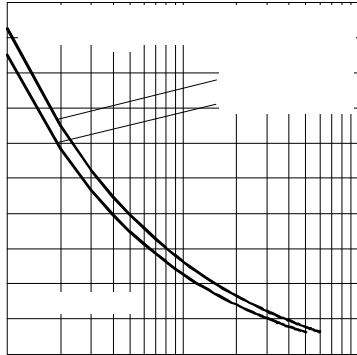

Fig. 5 - Maximum Non-repetitive Surge Current

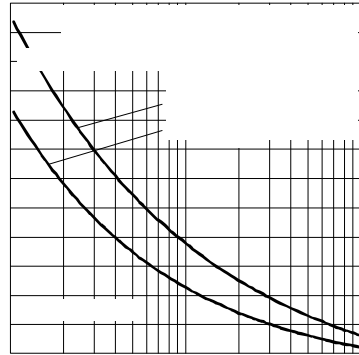

Fig. 6 - Maximum Non-repetitive Surge Current

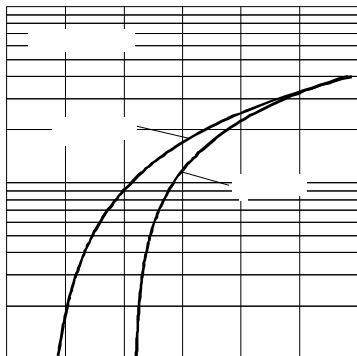

Fig. 7 - On-state Voltage Drop Characteristics

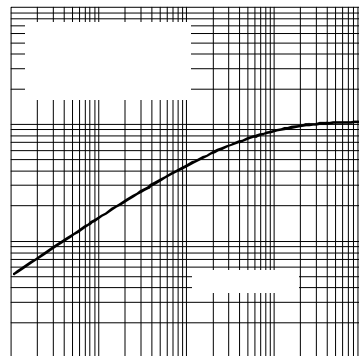

Fig. 8 - Thermal Impedance Z_{thJC} Characteristic

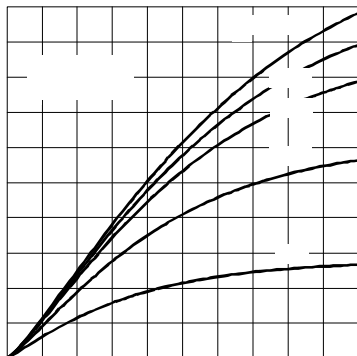

Fig. 9 - Reverse Recovered Charge Characteristics

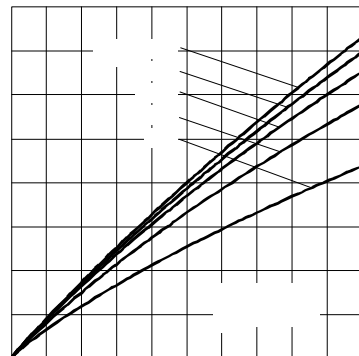

Fig. 10 - Reverse Recovery Current Characteristics



ST183S Series

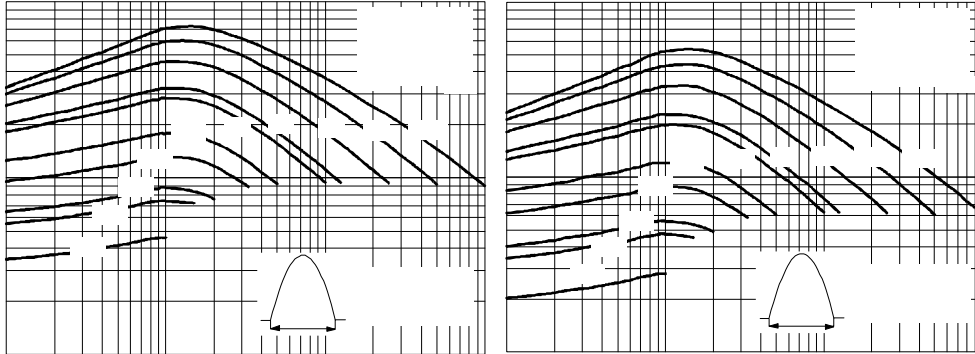

Fig. 11 - Frequency Characteristics

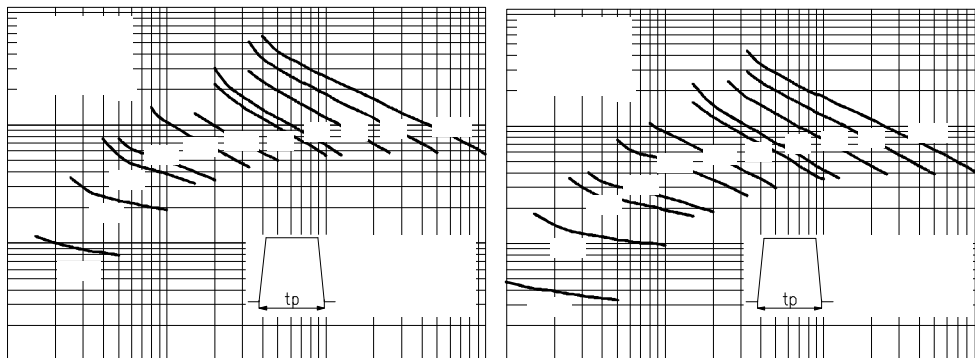

Fig. 12 - Frequency Characteristics

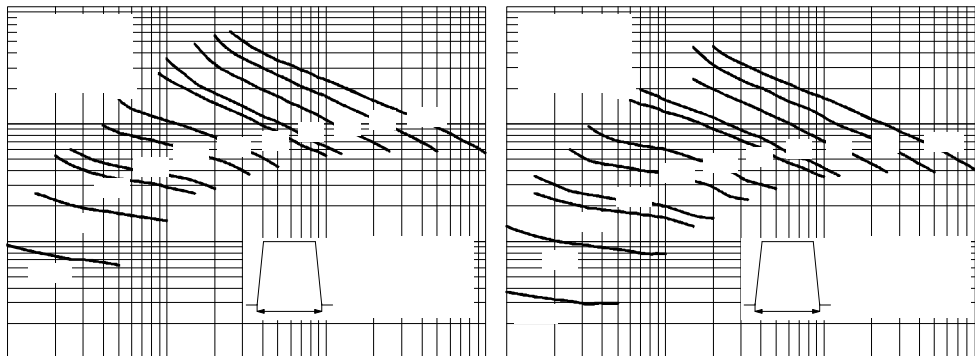

Fig. 13 - Frequency Characteristics



ST183S Series

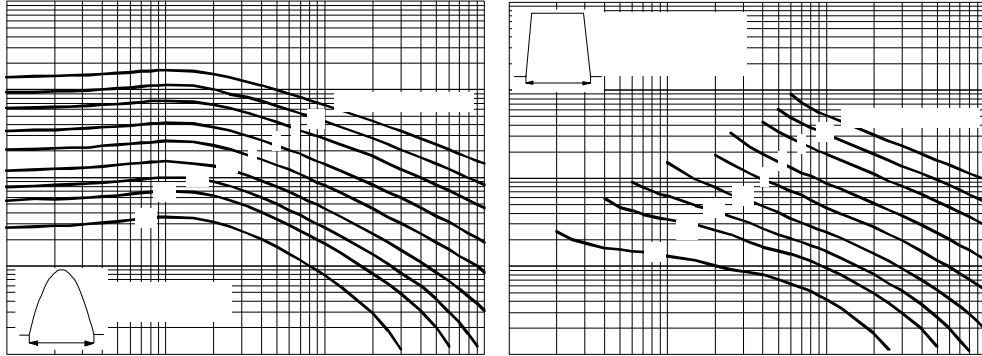

Fig. 14 - Maximum On-state Energy Power Loss Characteristics

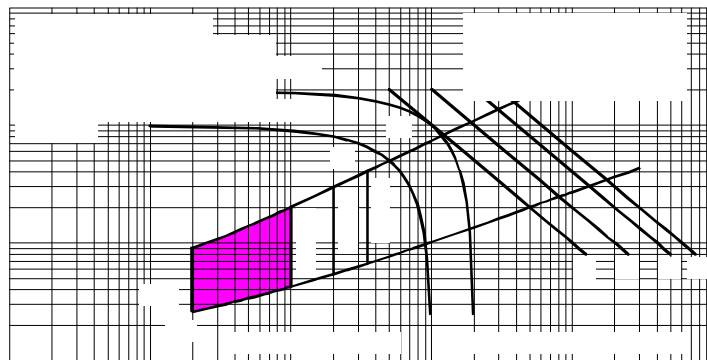

Fig. 15 - Gate Characteristics



ST183S Series

On-state Conduction

Parameter	ST183S	Units	Conditions
V_{TM} Max. peak on-state voltage	1.80	V	$I_{TM} = 600A, T_J = T_J \text{ max}, t_p = 10\text{ms sine wave pulse}$
$V_{T(TO)1}$ Low level value of threshold voltage	1.40		$(16.7\% \times \pi \times I_{T(AV)} < I < \pi \times I_{T(AV)}, T_J = T_J \text{ max.}$
$V_{T(TO)2}$ High level value of threshold voltage	1.45		$(I > \pi \times I_{T(AV)}, T_J = T_J \text{ max.}$
r_{t1} Low level value of forward slope resistance	0.67	m Ω	$(16.7\% \times \pi \times I_{T(AV)} < I < \pi \times I_{T(AV)}, T_J = T_J \text{ max.}$
r_{t2} High level value of forward slope resistance	0.58		$(I > \pi \times I_{T(AV)}, T_J = T_J \text{ max.}$
I_H Maximum holding current	600	mA	$T_J = 25^\circ\text{C}, I_T > 30A$
I_L Typical latching current	1000		$T_J = 25^\circ\text{C}, V_A = 12V, R_a = 6\Omega, I_G = 1A$

Switching

Parameter	ST183S	Units	Conditions
di/dt Max. non-repetitive rate of rise of turned-on current	1000	A/ μs	$T_J = T_J \text{ max}, V_{DRM} = \text{rated } V_{DRM}$ $I_{TM} = 2 \times di/dt$
t_d Typical delay time	1.1	μs	$T_J = 25^\circ\text{C}, V_{DM} = \text{rated } V_{DRM}, I_{TM} = 50A \text{ DC}, t_p = 1\mu\text{s}$ Resistive load, Gate pulse: 10V, 5 Ω source
t_q Max. turn-off time	Min 10, Max 20		$T_J = T_J \text{ max}, I_{TM} = 300A, \text{commutating } di/dt = 20A/\mu\text{s}$ $V_R = 50V, t_p = 500\mu\text{s}, dv/dt: \text{ see table in device code}$

Blocking

Parameter	ST183S	Units	Conditions
dv/dt Maximum critical rate of rise of off-state voltage	500	V/ μs	$T_J = T_J \text{ max.}, \text{ linear to } 80\% V_{DRM}, \text{ higher value available on request}$
I_{RRM} I_{DRM} Max. peak reverse and off-state leakage current	40	mA	$T_J = T_J \text{ max}, \text{ rated } V_{DRM}/V_{RRM} \text{ applied}$

Triggering

Parameter	ST183S	Units	Conditions
P_{GM} Maximum peak gate power	60	W	$T_J = T_J \text{ max}, f = 50\text{Hz}, d\% = 50$
$P_{G(AV)}$ Maximum average gate power	10		
I_{GM} Max. peak positive gate current	10	A	$T_J = T_J \text{ max}, t_p \leq 5\text{ms}$
$+V_{GM}$ Maximum peak positive gate voltage	20	V	$T_J = T_J \text{ max}, t_p \leq 5\text{ms}$
$-V_{GM}$ Maximum peak negative gate voltage	5		
I_{GT} Max. DC gate current required to trigger	200	mA	$T_J = T_J \text{ max}, V_A = 12V, R_a = 6\Omega$
V_{GT} Max. DC gate voltage required to trigger	3	V	
I_{GD} Max. DC gate current not to trigger	20	mA	$T_J = T_J \text{ max}, \text{ rated } V_{DRM} \text{ applied}$
V_{GD} Max. DC gate voltage not to trigger	0.25	V	



ST183S Series

Thermal and Mechanical Specifications

Parameter	ST183S	Units	Conditions
T_J Max. junction operating temperature range	-40 to 125	°C	
T_{stg} Max. storage temperature range	-40 to 150		
R_{thJC} Max. thermal resistance, junction to case	0.105	K/W	DC operation
R_{thCS} Max. thermal resistance, case to heatsink	0.04		Mounting surface, smooth, flat and greased
T Mounting torque, ± 10%	31 (275)	Nm (lbf-in)	Non lubricated threads
	24.5 (210)	Nm (lbf-in)	Lubricated threads
wt Approximate weight	280	g	
Case style	TO-209AB (TO-93)		See Outline Table

ΔR_{thJC} Conduction

(The following table shows the increment of thermal resistance R_{thJC} when devices operate at different conduction angles than DC)

Conduction angle	Sinusoidal conduction	Rectangular conduction	Units	Conditions
180°	0.016	0.012	K/W	$T_J = T_J \text{ max.}$
120°	0.019	0.020		
90°	0.025	0.027		
60°	0.036	0.037		
30°	0.060	0.060		

Ordering Information Table

Device Code

ST	18	3	S	08	P	F	N	0	
①	②	③	④	⑤	⑥	⑦	⑧	⑨	⑩

- 1** - Thyristor
- 2** - Essential part number
- 3** - 3 = Fast turn off
- 4** - S = Compression bonding Stud
- 5** - Voltage code: Code x 100 = V_{RRM} (See Voltage Ratings table)
- 6** - P = Stud base 3/4" 16UNF-2A
M = Stud base metric threads M16 x 1.5
- 7** - Reapplied dv/dt code (for t_q test condition)
- 8** - t_q code
- 9** - 0 = Eyelet terminals (Gate and Aux. Cathode Leads)
1 = Fast-on terminals (Gate and Aux. Cathode Leads)
2 = Flag terminals (For Cathode and Gate Terminals)
- 10** - Critical dv/dt:
None = 500V/μsec (Standard value)
L = 1000V/μsec (Special selection)

dv/dt - t_q combinations available						
dv/dt (V/μs)	20	50	100	200	400	
t_q (μs)	10	CN	DN	EN	FN *	HN
	12	CM	DM	EM	FM	HM
	15	CL	DL	EL	FL *	HL
	18	CP	DP	EP	FP	HP
	20	CK	DK	EK	FK	HK

*Standard part number.
All other types available only on request.



ST183S Series

Outline Table

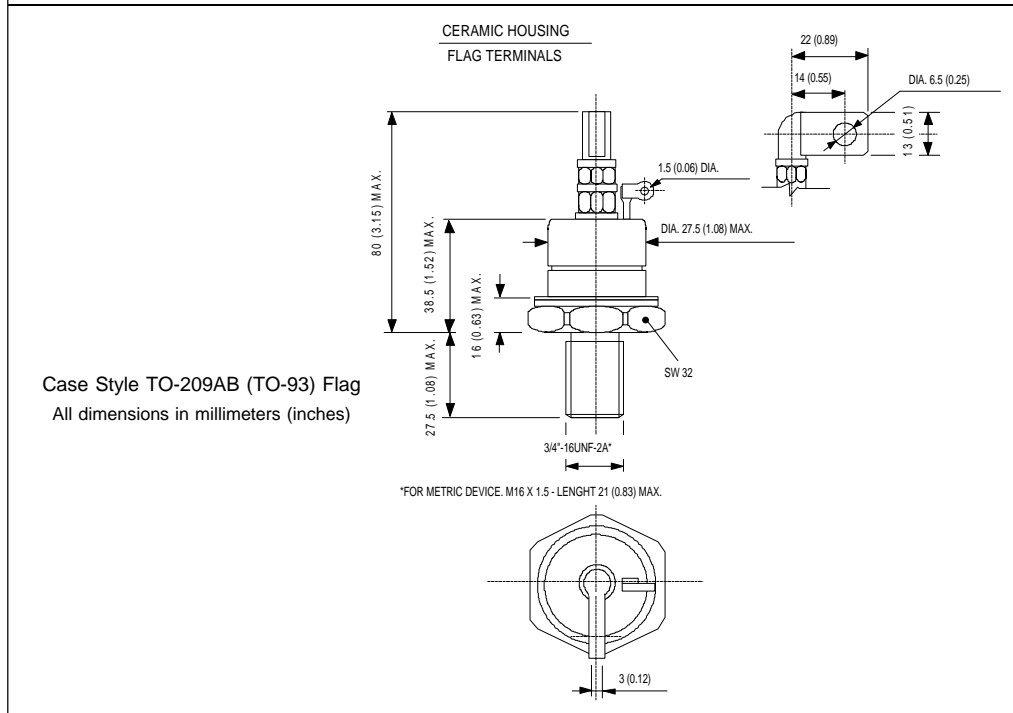
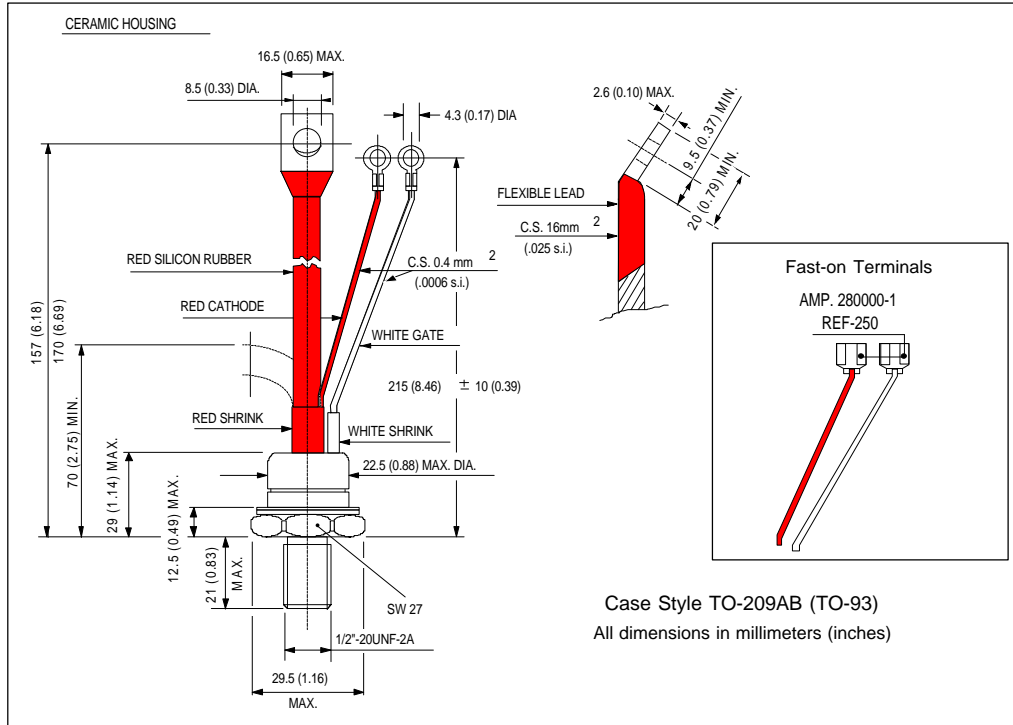

D-465