

### POWER MANAGEMENT

#### Description

The SC251 is a synchronous step-down converter designed for use as an adaptive voltage supply for WCDMA RF power amplifiers (PAs). An analog control input is used to adjust the output voltage dynamically between 0.5V and 3.4V using a non-linear transfer function. The non-linear relationship maximizes total system efficiency by providing the PA with the minimum voltage it needs to maintain linearity. For output voltages greater than 3.4V the input is connected directly to the output via an internal PMOS switch. An optional gate drive (GD) output to control an external low on-resistance PMOS switch is also provided for systems applications that require minimal voltage drop. The SC251 also provides a 2.85V LDO reference output that can be used to supply a PA bias input.

Low power and high power modes are provided to match performance with dual mode PAs. In low power mode the output voltage follows an exponential relationship with the VDAC input until it reaches 3.4V. When the VMODE pin changes state,  $V_{OUT}$  follows an alternate exponential relationship.

The SC251 is capable of supplying output current up to 800mA. Standby current is  $<1\mu A$  when the device is disabled. The internal clock runs at 1MHz so that small surface mount inductors and capacitors can be used.

#### Features

- ◆  $V_{OUT}$  exponentially proportional to  $V_{DAC}$  for maximum efficiency (patent pending)
- ◆ Output range and pass-through mode - 0.5V to 3.4V
- ◆ Output current - 800mA
- ◆ Shutdown current -  $<1\mu A$
- ◆ LDO PA bias supply - 2.85V, 10mA
- ◆ Internal clock - 1MHz
- ◆ Continuous short circuit protection on VOUT
- ◆ Duty cycle mode - 100%
- ◆ Internal PMOS bypass transistor
- ◆ Gate drive available for external bypass transistor
- ◆ Over 90% efficiency
- ◆ Low and high power modes for optimum dual-mode PA efficiency
- ◆ Switching time (lowest to highest output)  $<40\mu s$
- ◆ Micro-lead frame package MLPD-10, 3mm x 3mm

#### Applications

- ◆ 3G mobile phones - RF PA power supply
- ◆ WCDMA power amplifier modules
- ◆ Wireless modems

#### Typical Application Circuit

#### Patent Pending

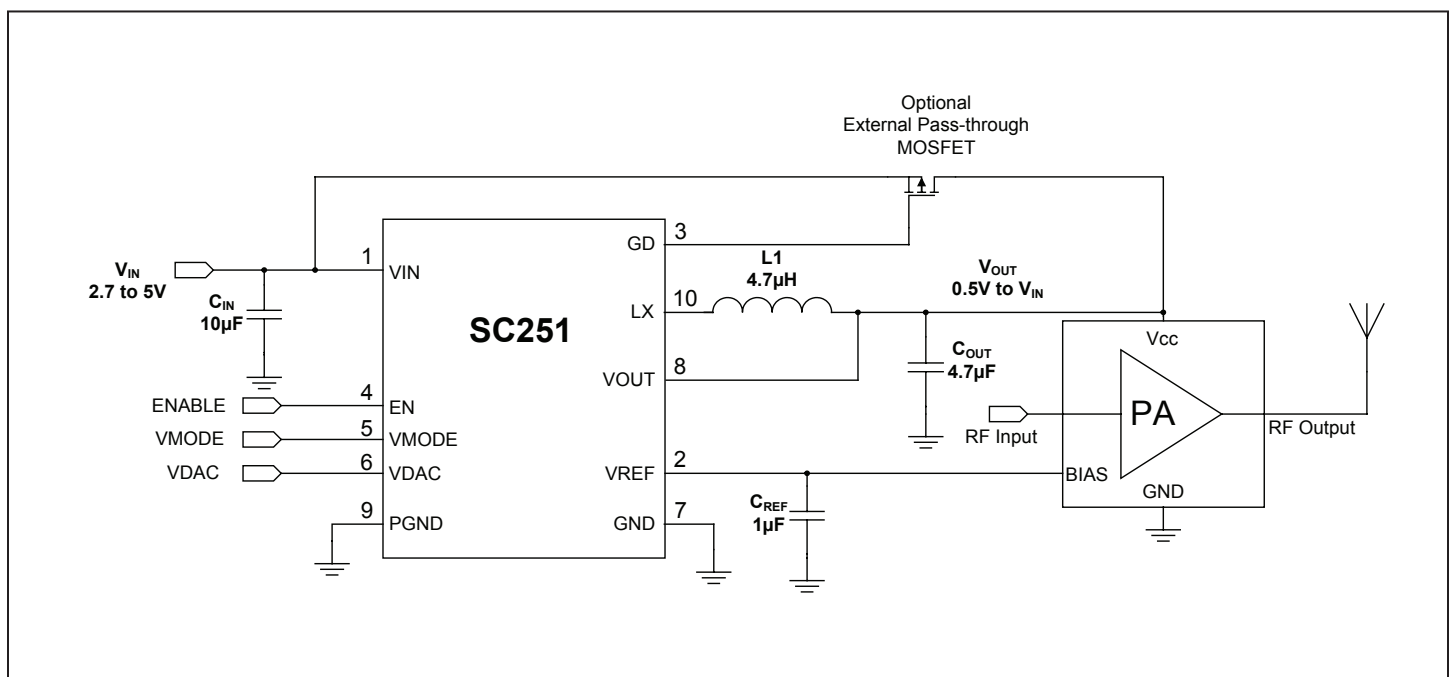

**POWER MANAGEMENT**
**Absolute Maximum Ratings**

Exceeding the specifications below may result in permanent damage to the device or device malfunction. Operation outside of the parameters specified in the Electrical Characteristics section is not recommended.

Parameter	Symbol	Maximum	Units
Input Supply Voltage	$V_{IN}$	-0.3 to 7	V
Logic Inputs/Outputs (EN, VMODE, VDAC, GD)	$V_N$	-0.3 to $V_{IN} + 0.3$ , 7V Max	V
Output Voltage	$V_{OUT}$	-0.3 to $V_{IN} + 0.3$ , 7V Max	V
LX Voltage	$V_{LX}$	-1 to $V_{IN} + 1$ , 7V Max	V
Thermal Impedance Junction to Ambient <sup>(1)</sup>	$\theta_{JA}$	49	°C/W
VOU Short-Circuit to GND	$t_{sc}$	Continuous	s
Operating Ambient Temperature Range	$T_A$	-40 to +85	°C
Storage Temperature	$T_S$	-60 to +160	°C
Maximum Junction Temperature	$T_J$	-40 to +150	°C
Peak IR Reflow Temperature	$T_{LEAD}$	260	°C
ESD Protection Level <sup>(2)</sup>	$V_{ESD}$	2	kV

Notes:

1. Calculated from package in still air, mounted to 3" x 4.5", 4 layer FR4 PCB with thermal vias under exposed pad pre JESD51 standards.
2. Tested according JEDEC standard JESD22-A114-B

**Electrical Characteristics**

Unless otherwise noted:  $V_{IN} = 4V$ ,  $EN = V_{IN}$ ,  $V_{MODE} = GND$  (High Power),  $V_{DAC} = 1.1V$ ,  $T_A = -40$  to  $85^\circ C$ . Typical values are at  $T_A = +25^\circ C$ .

Parameter	Symbol	Conditions	Min	Typ	Max	Units
Input Voltage Range	$V_{IN}$		2.7		5	V
$V_{OUT}$ Accuracy	$V_{OUT}$	$V_{DAC} = 0.3V$ , $V_{MODE} = V_{IN}$ , $I_{OUT} = 20mA$	0.44	0.48	0.52	V
		$V_{MODE} = V_{IN}$ , $I_{OUT} = 60mA$	3.16	3.40	3.64	
		$I_{OUT} = 200mA$	1.38	1.62	1.86	
Line Regulation	$V_{OUT LINE}$	$V_{IN} = 2.7V$ to $5V$ , $I_{OUT} = 200mA$ , $T_A = -40$ to $85^\circ C$		$\pm 1.2$		%
Load Regulation (PWM)	$V_{OUT LOAD}$	$I_{OUT} = 0A$ to $800mA$ , $T_A = -40$ to $85^\circ C$		$\pm 0.5$		%
Peak Inductor Current	$I_{LX PK}$		1		1.7	A
Bypass FET current limit	$I_{PASS}$		1		2.5	A
Quiescent Current	$I_{Q NORM}$			2.5		mA
	$I_{Q PASS}$	$V_{DAC} = 1.3V$		1.5		

**POWER MANAGEMENT**
**Electrical Characteristics (Cont.)**

Parameter	Symbol	Conditions	Min	Typ	Max	Units
Shutdown Current	$I_{SD}$	EN = GND		0.1	3	$\mu$ A
P-Channel Current Limit	$I_{LIM(P)}$		0.9	1.3	1.7	A
$V_{DAC}$ Pass-through Mode Threshold	$V_{DAC PASS}$	$V_{DAC}$ rising	1.24	1.28	1.32	V
		$V_{DAC}$ falling	1.2	1.245		
$V_{DAC}$ Pass-through Mode Hysteresis	$V_{DAC HYST}$			40		mV
$V_{REF}$ Output	$V_{REF}$	$I_{REF} = 10mA$	2.75	2.85	2.95	V
$V_{REF}$ LDO Dropout	$V_{REF DO}$	$I_{REF} = 10mA$			100	mV
$V_{REF}$ Load Current	$I_{REF}$				10	mA
$V_{REF}$ Load Regulation	$V_{REF LDREG}$	$I_{REF} = 0.1mA$ to 10mA			0.05	%/mA
$V_{REF}$ Line Regulation	$V_{REF LNREG}$	$I_{REF} = 1 mA$			0.3	%/V
GD Load Capacitance	$C_{GD}$			10		nF
GD Source Current	$I_{GDH}$	$T_A = 25^{\circ}C$		0.5	2	mA
GD Sink Current	$I_{GDL}$	$V_{DAC} = 1.4V, T_A = 25^{\circ}C$		75	150	mA
$R_{DSon}$ of P-Channel FET	$R_{PFET}$	$V_{IN} = 3V, I_{OUT} = 100mA$		0.4		$\Omega$
$R_{DSon}$ of N-Channel FET	$R_{NFET}$	$V_{IN} = 3V, I_{OUT} = 100mA$		0.25		$\Omega$
$R_{DSon}$ of Bypass P-Channel FET	$R_{PASS}$	$I_{OUT} = 600mA, V_{IN} = 3V, V_{DAC} = 1.4V$		0.2		$\Omega$
LX Pin PMOS Leakage	$I_{LLXP}$	EN=GND, $V_{IN} = 3.6V, LX = GND$		0.1		$\mu$ A
VOUT Pin Bypass FET Leakage	$I_{LVOUT}$	EN=GND, $V_{IN} = 3.6V, V_{OUT} = GND$		0.1	3	$\mu$ A
Oscillator Frequency	$f_{OSC}$	$V_{DAC} > 0.95V$	0.85	1	1.15	MHz
		$V_{DAC} < 0.95V$	0.65		1.15	
Logic Input High	$V_{IH}$	EN / VMODE increasing	1.6			V
Logic Input Low	$V_{IL}$	EN / VMODE decreasing			0.6	V
Logic Input Current High	$I_{IH}$	EN / VMODE = 5.0V			$\pm 2$	$\mu$ A
Logic Input Current Low	$I_{IL}$	EN / VMODE = 0V			$\pm 2$	$\mu$ A
Enable Transient Over/Undershoot <sup>(1)</sup>	$OS_{EN}$				20	%

**POWER MANAGEMENT**
**Electrical Characteristics (Cont.)**

Parameter	Symbol	Conditions	Min	Typ	Max	Units
Enable Transient Settling Time <sup>(1)</sup>	$t_{EN-ST}$				40	$\mu s$
VDAC Transient Over/Undershoot <sup>(1)</sup>	$OS_{VDAC}$				20	%
VDAC Transient Settling Time <sup>(1)</sup>	$t_{VDAC-ST}$				40	$\mu s$
Pass-Through Transition Over/Undershoot <sup>(1)</sup>	$OS_{PASS}$				20	%
Pass-Through Transition Settling Time <sup>(1)</sup>	$t_{PASS-ST}$				40	$\mu s$
Thermal Shutdown	$T_{SD}$			160		$^{\circ}C$
Thermal Shutdown Hysteresis	$T_{SDH}$			15		$^{\circ}C$

**Notes:**

1) Not tested - guaranteed by design.

**POWER MANAGEMENT**

**Pin Configuration**

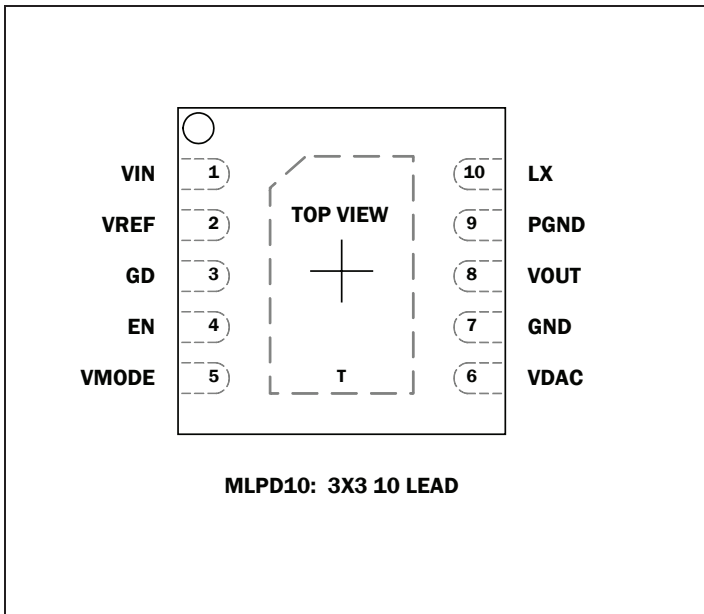

**Ordering Information**

DEVICE	PACKAGE
SC251MLTRT <sup>(1) (2)</sup>	MLP 3x3-10
SC251EVB	Evaluation Board

Notes:

- 1) Lead-free packaging only. This product is fully WEEE and RoHS compliant.
- 2) Available in tape and reel only. A reel contains 3000 devices.

**Marking Information**



POWER MANAGEMENT

Block Diagram

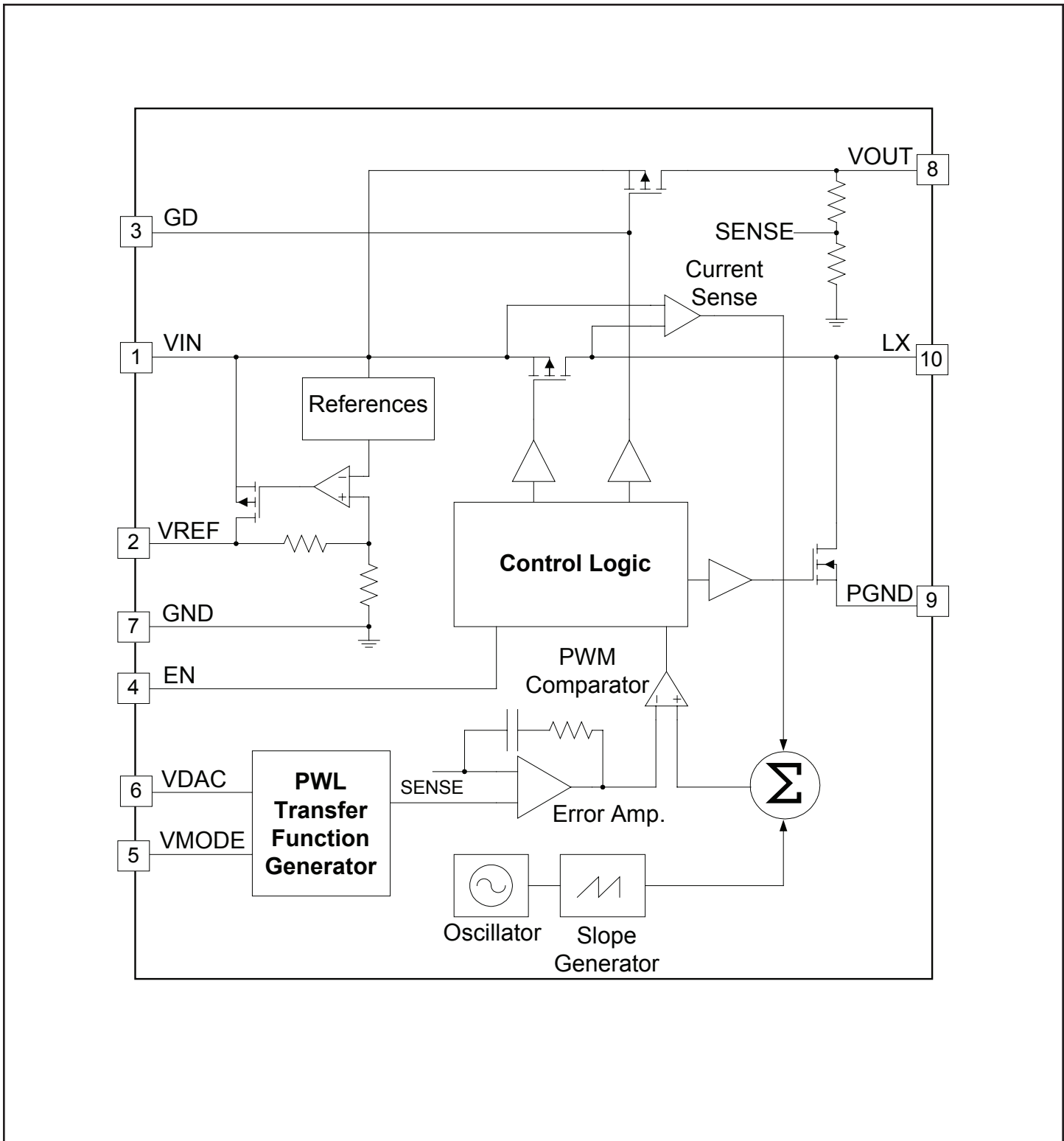

**POWER MANAGEMENT**
**Pin Description**

Pin#	Pin Name	Pin Function
1	VIN	Input supply pin.
2	VREF	A 2.85V LDO reference voltage supply - 10mA max load that can be used as a supply for power amplifier bias inputs.
3	GD	A push pull external PFET Gate drive control output - connect to the gate of an external MOSFET to control a low resistance path between $V_{IN}$ and $V_{OUT}$ when low voltage drop is needed (optional - if not used leave floating). A low state turns on the MOSFET.
4	EN	Enable pin - controls both the switching converter and the VREF output. Active high.
5	VMODE	Input control to select the $V_{DAC}$ to $V_{OUT}$ profile (high = low power, low = high power).
6	VDAC	Analog control voltage input - ranges between 0.3 and 1.2V for exponential control of $V_{OUT}$ , $V_{DAC} > 1.28$ enables pass-through mode (using internal pass MOSFET or optional low $R_{DSON}$ MOSFET controlled by GD).
7	GND	System and logic ground.
8	VOUT	Output voltage pin.
9	PGND	Ground reference for internal N-channel MOSFET.
10	LX	Switch node connection to inductor. This pin connects to the drains of the internal main and synchronous power MOSFET switches.
T	Thermal Pad	Pad for heatsinking purposes. Connect to ground plane using multiple vias. Not connected internally.

**POWER MANAGEMENT**

**Applications Information**

**SC251 Detailed Description**

The SC251 is a step-down, fixed frequency pulse-width modulated DC-DC converter designed for use with RF power amplifiers (PAs) in WCDMA handsets and modules.

The output is used to supply DC power to the PA rather than connecting the DC input pin directly to the battery supply. A substantial system power efficiency improvement can be achieved by allowing the system controller to adaptively adjust the DC voltage to the PA, reducing the total power consumption of the device. To maximize efficiency at all RF output gain settings, the PA supply voltage is adjusted exponentially, minimizing PA supply headroom and losses. The benefit of having an exponential  $V_{OUT}$  vs.  $V_{DAC}$  relationship is clearly seen when plotted on the same graph as linear relationships, see following figure. The SC251  $V_{OUT}$  vs.  $V_{DAC}$  transfer function is optimized to provide the lowest supply voltage to maintain the PA's linearity. This provides the best possible balance between Adjacent Channel Leakage Ratio (ACLR) margin and efficiency requirements.

By using a switching regulator, less current is needed than when the PA is connected directly to the battery or an LDO. Reduced current consumption results in more talk-time for the handset.

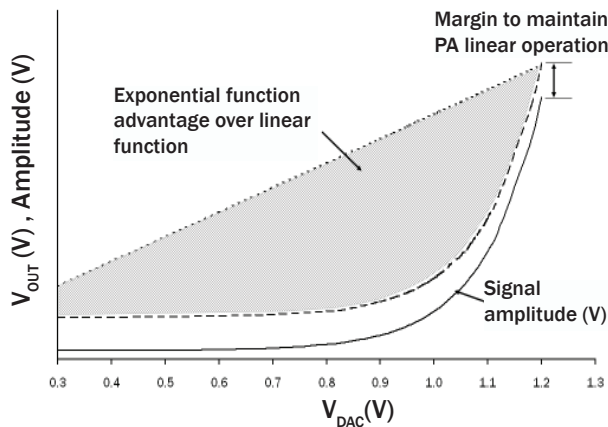

**Figure 1 - Advantage of exponential Transfer Function**

**Operation Modes**

The SC251 output voltage is dependent on the  $V_{DAC}$  analog control voltage and the  $V_{MODE}$  digital control input. In each mode  $V_{OUT}$  follows a different  $V_{DAC}$  transfer function that is designed to produce maximum power amplifier efficiency. When  $V_{MODE}$  is high the device is in low power mode, and when  $V_{MODE}$  is low the device switches to high power mode. The relationships between  $V_{OUT}$  and  $V_{DAC}$  in both modes are optimized to achieve the best efficiency from a dual-mode PA design. These relationships are shown in the following figure. The system controller determines the output power level needed from the PA and adjusts the  $V_{DAC}$  voltage accordingly. The SC251 monitors the  $V_{DAC}$  voltage and adjusts the output voltage supply to the PA to optimize efficiency and maintain PA linearity.

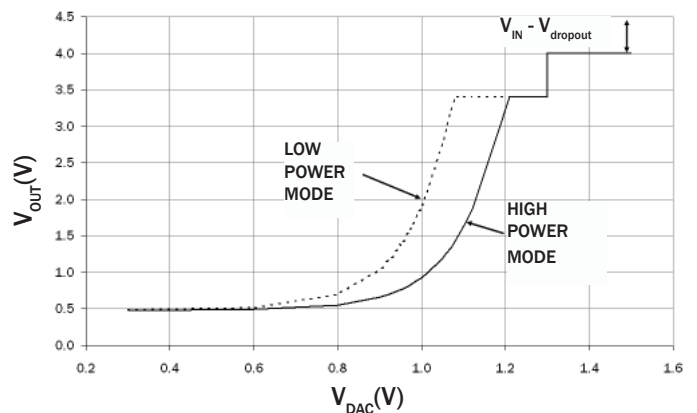

**Figure 2 -  $V_{DAC}$  to  $V_{OUT}$  Transfer Functions**

**Low Power Mode**

The SC251 enters low power mode when the  $V_{MODE}$  pin is pulled high. In this mode the  $V_{DAC}$  to  $V_{OUT}$  transfer function is set to follow the dotted line curve shown in Figure 2. The output voltage starts at 0.5V for low power settings and increases exponentially until it reaches the maximum of 3.4V. If the power control for the PA requires the output voltage to exceed 3.4V, then the SC251 goes into pass-through mode and  $V_{OUT}$  is equal to  $V_{IN}$  minus the voltage dropped across the pass-through device (see pass-through mode for more details).

A typical WCDMA load profile for low power mode, with the minimum and maximum current limits, is shown in Figure 3.

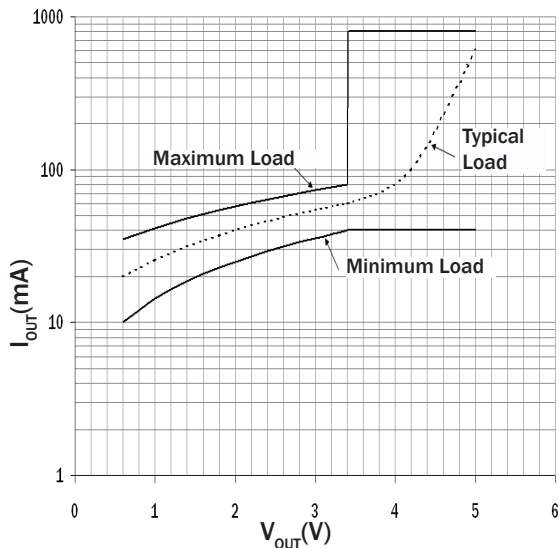
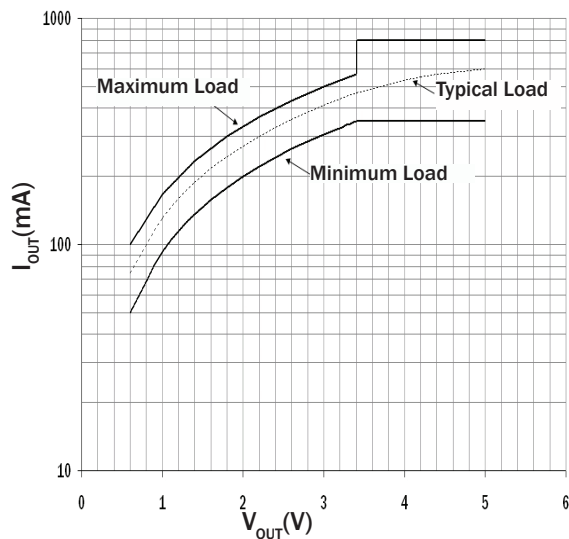

**Figure 3 - Load Profile-Low Power Mode**

**Figure 4 - Load Profile-High Power Mode**

### High Power Mode

The SC251 enters high power mode when the VMODE pin is pulled low. In this mode the  $V_{DAC}$  to  $V_{OUT}$  transfer function is set to follow the solid line curve shown in Figure 2. The output voltage again starts at 0.5V and increases exponentially as the power demand increases until it reaches the maximum of 3.4V. A typical WCDMA load profile for high power mode with the minimum and maximum current limits is shown in Figure 4. If the power control for the PA requires the output voltage to exceed 3.4V, then the SC251 goes into pass-through mode and  $V_{OUT}$  is equal to  $V_{IN}$  minus the voltage dropped across the pass-through device ( $V_{dropout}$ ).

In high power mode the PA gain is constant, but output impedance is lower and the subsequent input voltage required to achieve the desired output power is less than in low power mode. The SC251 output, therefore, switches to the solid line curve in the  $V_{DAC}$ -to-  $V_{OUT}$  in Figure 2. The lower output voltage required improves efficiency over a single mode system by lowering the voltage required for a fixed current load.

### 100% Duty Cycle Operation

When the input supply voltage approaches the programmed output voltage the PMOS on-time extends until the supply voltage gets within 400mV of the output voltage. At this point both the internal pass device and the PMOS switching device automatically turns on, connecting  $V_{IN}$  to  $V_{OUT}$ . The bypass device and PMOS switching device remains fully on until either the  $V_{IN}$  voltage is increased by 150mV or the programmed  $V_{OUT}$  voltage is reduced such that  $V_{IN} - V_{OUT}$  is greater than 650mV. Bypassing the impedance of the inductor and switching PMOS device improves efficiency by minimizing the voltage drop from  $V_{OUT}$  to  $V_{IN}$ .

### Pass-Through Mode

This mode is entered when the  $V_{DAC}$  voltage reaches 1.28V. If the demanded output voltage is within 400mV of the input voltage the device automatically enters pass-through as this exceeds the maximum controlled duty cycle of the power converter. In pass-through mode the device enables an internal P-channel MOSFET that bypasses the converter, connecting the output directly to the input. The  $R_{DSon}$  of this FET is extremely low so there is little voltage drop across the part. If the system designer determines that the pass-through resistance is too high for the application, there is an optional gate-drive output that can be used with an external switch.

The GD pin becomes active-low only when  $V_{DAC}$  is greater than 1.4V. This pin can be connected to the gate of an external low- $R_{DSon}$  P-channel MOSFET whose source and drain are connected to  $V_{IN}$  and  $V_{OUT}$ , respectively. This option allows the lowest insertion loss possible between  $V_{IN}$  and  $V_{OUT}$ . Note that GD should not be loaded with a DC current. GD is monitored so that the part remains in pass-through until GD reaches within 600mV of  $V_{IN}$ .

### Bias Supply Output

In addition to the main output the SC251 also provides a low current LDO reference output that can be used as a

**POWER MANAGEMENT**
**Applications Information (Cont.)**

bias supply for power amplifiers. This output provides a regulated 2.85V with output current capability up to 10mA. The 2.85V output is guaranteed for input supply voltages in excess of 2.95V. When input voltages below 2.95V are used,  $V_{REF}$  is equal to  $V_{IN} - V_{REF\_DO}$ . This reference supply is controlled by the same enable pin as the switching regulator.

**Protection Features**

The SC251 provides the following protection features:

- Thermal shutdown
- Current limit
- Under voltage lockout

**Thermal Shutdown**

The device has a thermal shutdown feature to protect the device if the junction temperature exceeds 160°C. In thermal shutdown the on-chip power devices are disabled, effectively tri-stating the LX output. Switching will resume when the temperature drops by 15°C.

**Short Circuit Protection**

The PMOS and NMOS power devices of the buck switcher stage are protected by current limit functions. In the event of a short to ground on the output, the LX pin will switch with minimum duty cycle. The duty cycle is short enough to allow the inductor to discharge during each cycle, thereby preventing the inductor current from “staircasing”.

The pass-through PMOS is protected by a current limit function. When the part is enabled in pass-through, the output capacitor charges up with a large surge current. In order to support this surge current and to protect against short circuits, an internal timer is used. A short circuit condition must exist for more than 128 clock cycles before the pass-through device is disabled. After an additional 2048 clock cycles, the pass-through device will turn back on. This cycle will continue until the short circuit is removed. This method allows the part to manage thermal dissipation and recover when the fault condition is removed.

**Under Voltage Lockout**

The part will turn itself off if the input supply voltage falls below 2.4V typical. The device is allowed to turn on again when the input supply voltage increases above the lockout voltage. Hysteresis is included to prevent chattering.

**Inductor Selection**

The SC251 is designed for use with a 4.7μH inductor. The magnitude of the inductor current ripple is dependent on the inductor value and can be determined by the following equation:

$$\Delta I_L = \frac{V_{OUT} \left( 1 - \frac{V_{OUT}}{V_{IN}} \right)}{L \times f_{OSC}}$$

The inductor should have a low DC Resistance (DCR) to minimize the conduction losses and maximize efficiency. As a minimum requirement, the DC current rating of the inductor should be equal to the maximum load current plus half of the inductor current ripple as shown by the following equation:

$$I_{LPK} = I_{OUT(MAX)} + \frac{\Delta I_L}{2}$$

Final inductor selection will depend on various design considerations such as efficiency, EMI, size and cost. Table 1 lists the manufacturers of practical inductor options.

**C<sub>IN</sub> Selection**

The source input current to a buck converter is non-continuous. To prevent large input voltage ripple a low ESR ceramic capacitor is required. A minimum value of 10μF should be used for sufficient input voltage filtering and a 22μF should be used for improved input voltage filtering.

**C<sub>OUT</sub> Selection**

The internal compensation is designed to work with a certain output filter corner frequency defined by the equation:

$$f_c = \frac{1}{2\pi\sqrt{L \times C_{OUT}}}$$

This single pole filter is designed to operate with an output capacitor value of 4.7μF.

Output voltage ripple is a combination of the voltage ripple from the inductor current charging and discharging the output capacitor and the voltage created from the inductor current ripple through the output capacitor ESR. Selecting an output capacitor with a low ESR reduces the

**POWER MANAGEMENT**

**Applications Information (Cont.)**

output voltage ripple component that is dependent upon this ESR, as can be seen in the following equation:

$$\Delta V_{OUT(ESR)} = \Delta I_{L(ripple)} \times ESR_{(COUT)}$$

Capacitors with X7R or X5R ceramic dielectric should be used for their low ESR and superior temperature and voltage characteristics. Y5V capacitors should not be used as their temperature coefficients make them impractical for this application. The following tables lists the manufacturers of recommended capacitor and inductor options.

**Table 1: Recommended Inductors**

Manufacturer/Part #	Value $\mu H$	DCR $\Omega$	Saturation Current A	Tolerance $\pm\%$	Dimensions (LxWxH) mm
BI Technologies HM66304R7	4.7	0.072	1.32	20	4.7 × 4.7 × 3.0
Coilcraft D01608C-472ML	4.7	0.09	1.5	20	6.6 × 4.5 × 3.0
TDK VLCF4018T-4R7N1R0-2	4.7	0.101	1.07	30	4.3 × 4.0 × 1.8

**Table 2: Recommended Capacitors**

Manufacturer/Part #	Value $\mu F$	Rated Voltage VDC	Temperature Characteristic	Case Size
Murata GRM219R 61A475KE34B	4.7	6.3	X5R	0603
TDK C1608JF0J475Z	4.7	6.3	X5R	0603
Murata GRM219R 60J106K E19B	10	6.3	X5R	0603
TDK C2012JB0J106K	10	6.3	X5R	0805

**POWER MANAGEMENT**

**Applications Information (Cont.)**

**PCB Layout Considerations**

Poor layout can degrade the performance of the DC-DC converter and can be a contributory factor in EMI problems, ground bounce and resistive voltage losses. Poor regulation and instability can result.

A few simple design rules can be implemented to ensure good layout:

1. Place the inductor and filter capacitors as close to the device as possible and use short wide traces between the power components.

2. Route the output voltage feedback and  $V_{DAC}$  path away from the inductor and LX node to minimize noise and magnetic interference.
3. Maximize ground metal on component side to improve the return connection and thermal dissipation. Separation between the LX node and GND should be maintained to avoid coupling of switching noise to the ground plane.
4. To further reduce noise interference on sensitive circuit nodes, use a ground plane with several vias connecting to the component side ground.

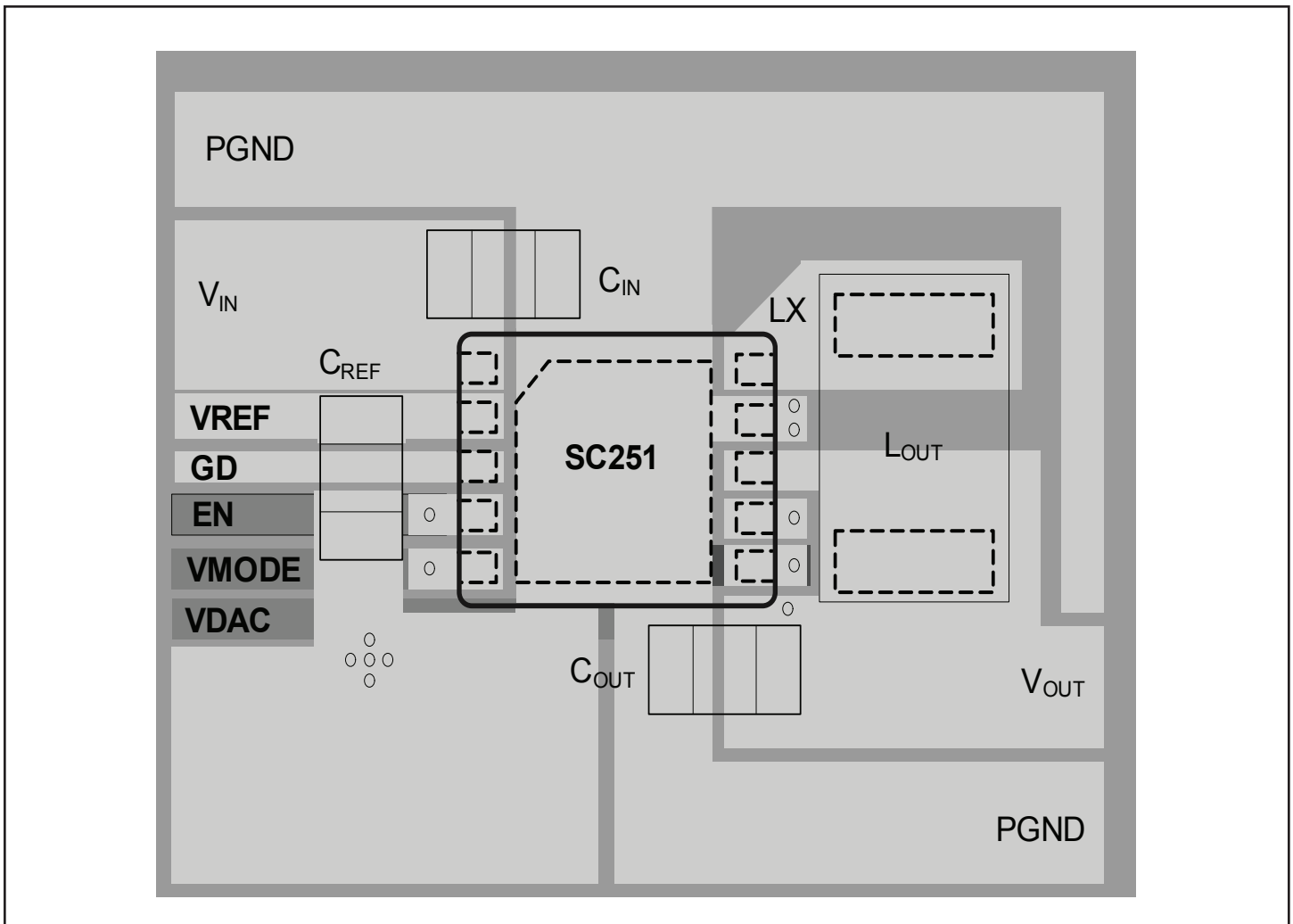

POWER MANAGEMENT

Typical Characteristics

Efficiency vs. Load

$V_{OUT} = 1.8V$

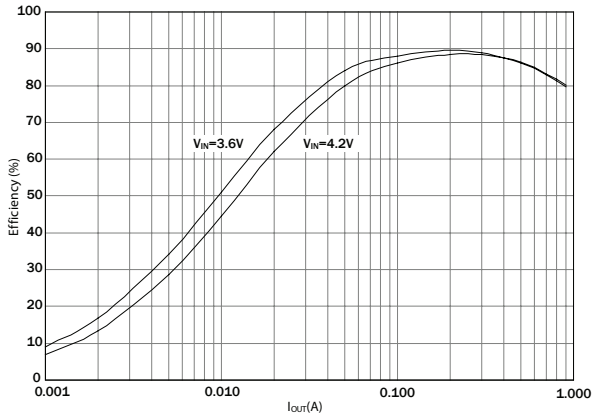

Efficiency vs. Load

$V_{OUT} = 1.2V$

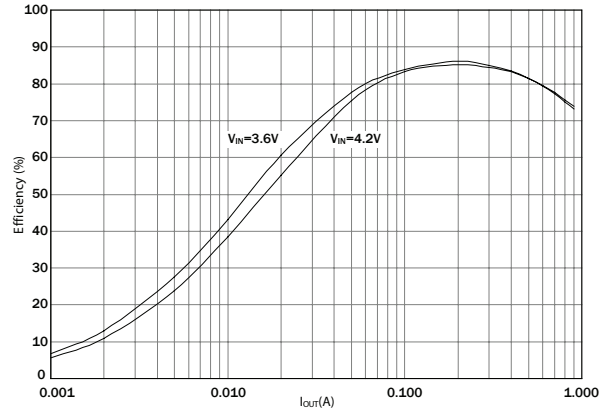

Efficiency vs. Load

$V_{OUT} = 1.5V$

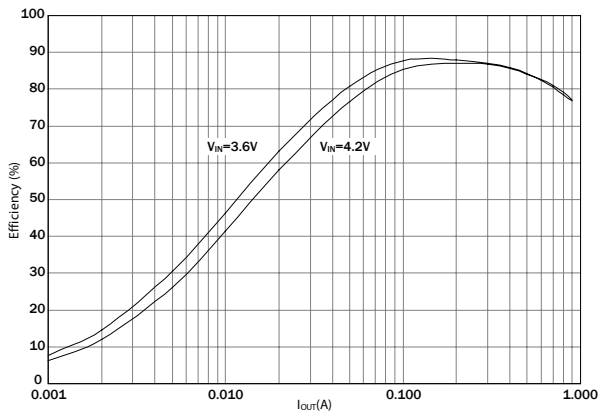

Efficiency vs. Load

$V_{OUT} = 2.5V$

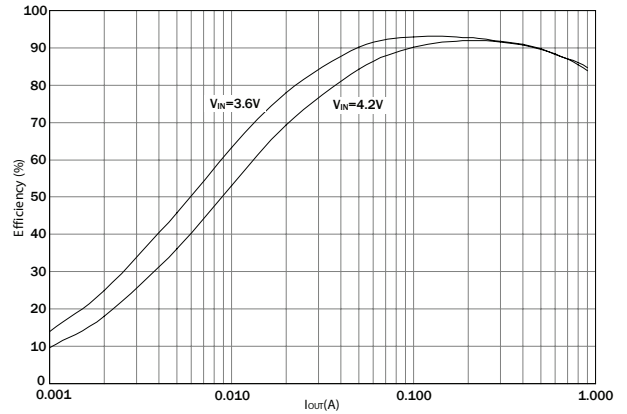

Efficiency vs. Load

$V_{OUT} = 3.4V$  (Pass-Through)

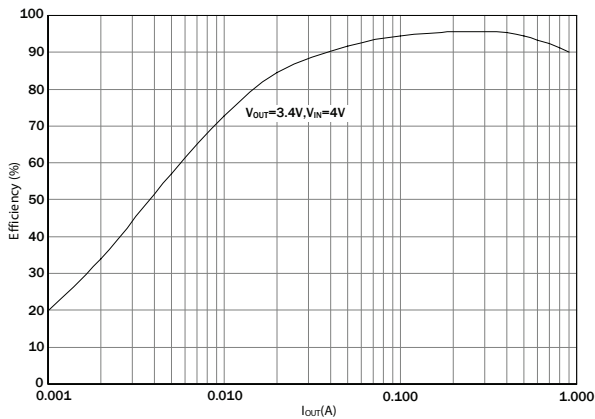

Efficiency vs.  $V_{IN}$

$V_{OUT} = 1.8V$

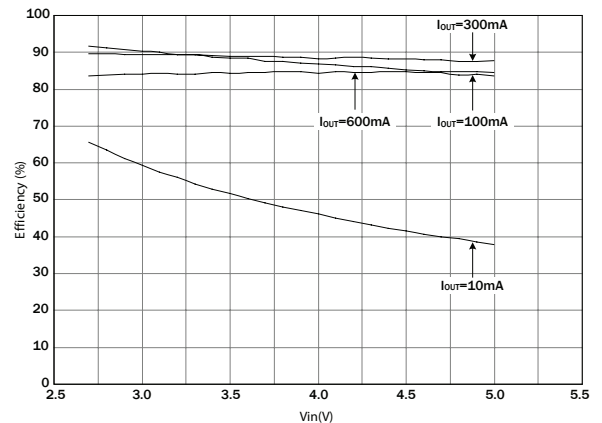

POWER MANAGEMENT

Typical Characteristics (Cont.)

Efficiency vs.  $V_{OUT}$

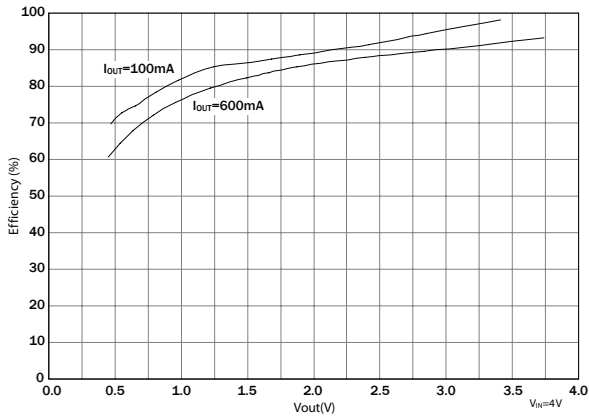

$V_{OUT}$  vs.  $V_{DAC}$

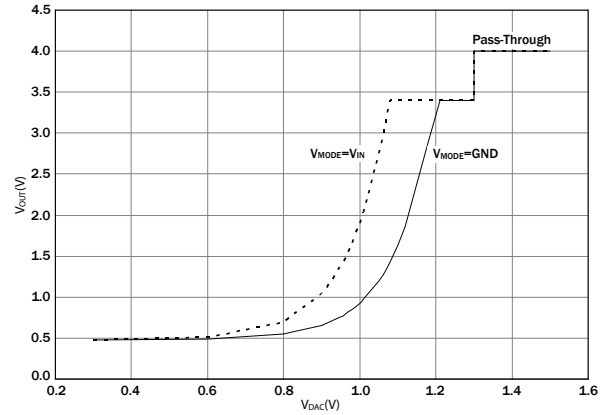

$V_{OUT}$  vs.  $I_{OUT}$

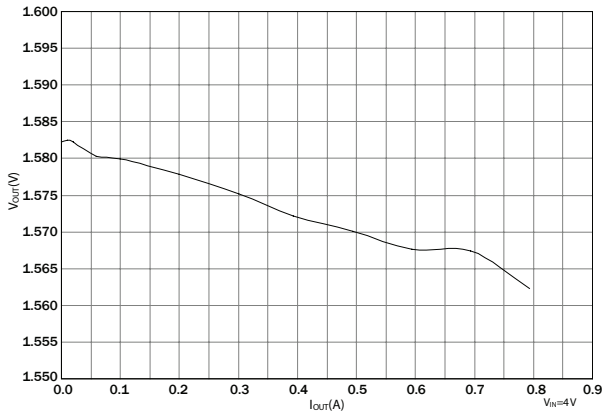

$V_{REF}$  vs.  $V_{IN}$

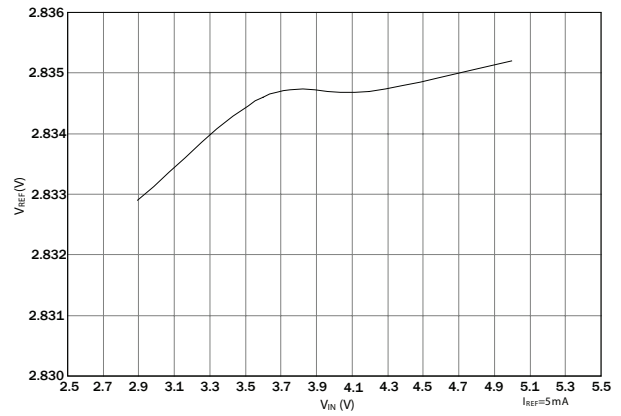

Oscillator Frequency vs.  $V_{IN}$

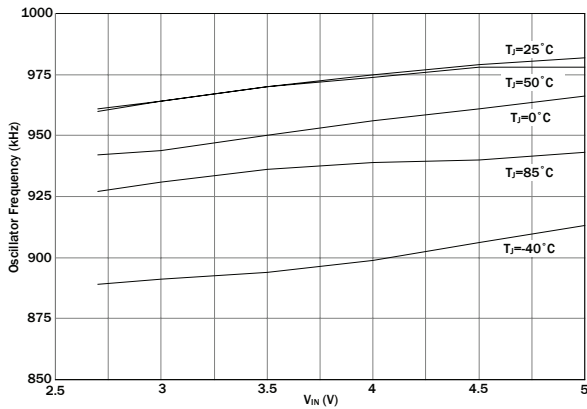

$V_{REF}$  vs.  $I_{REF}$

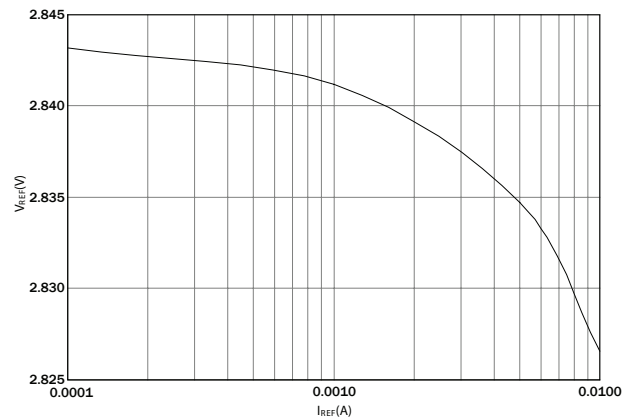

POWER MANAGEMENT

Typical Characteristics (Cont.)

Oscillator Frequency vs. Temperature

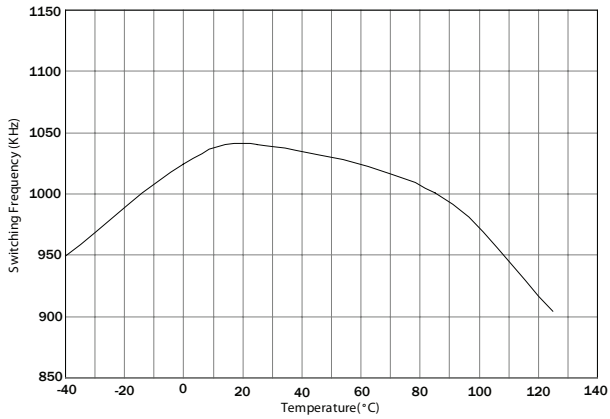

$R_{DS(ON)}$  vs.  $V_{IN}$

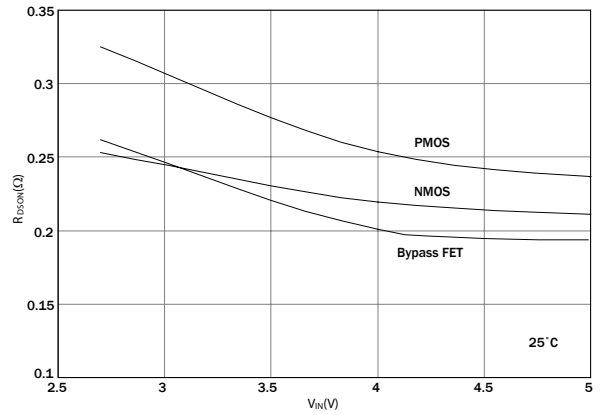

$R_{DS(ON)}$  vs. Temperature

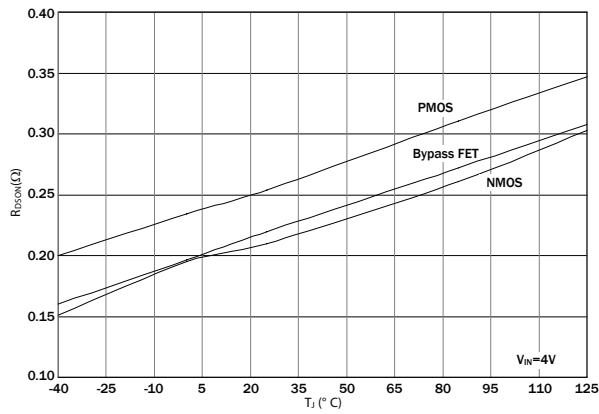

PMOS FET Leakage vs. Temperature

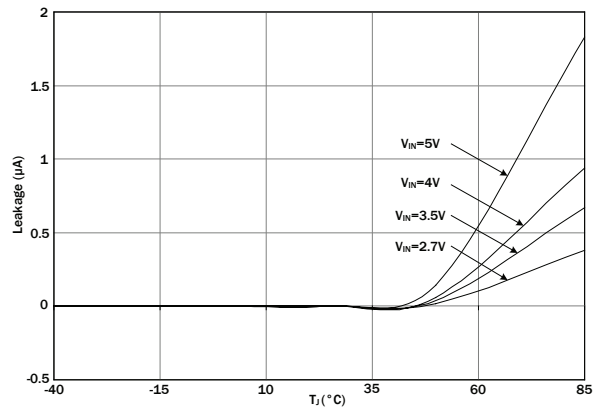

PASS FET Leakage vs. Input Voltage

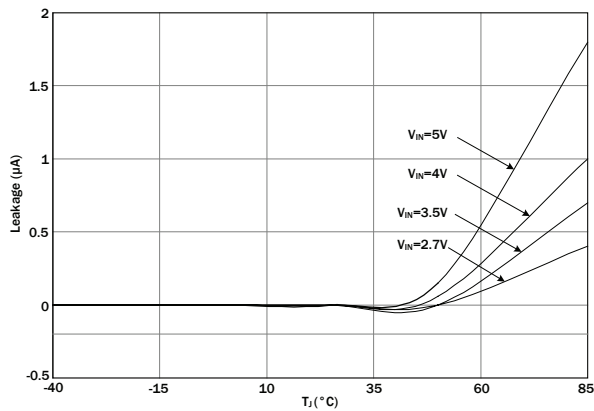

Dynamic Supply Current vs.  $V_{IN}$

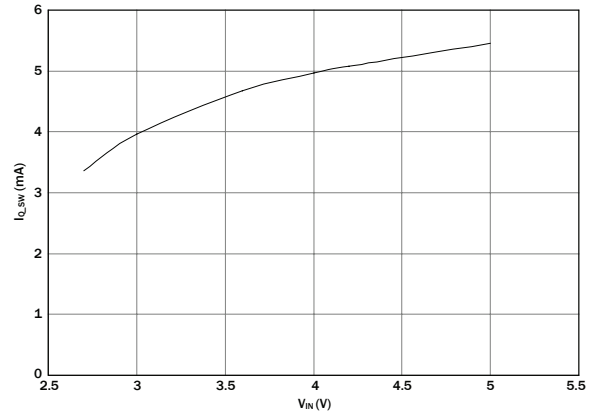

POWER MANAGEMENT

Typical Characteristics (Cont.)

Enable Startup

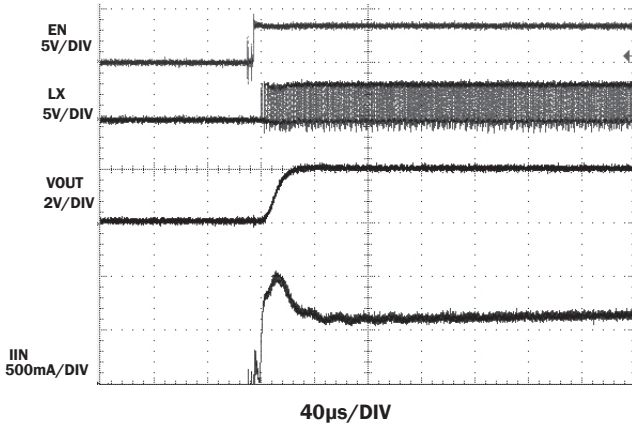

Load Step Response

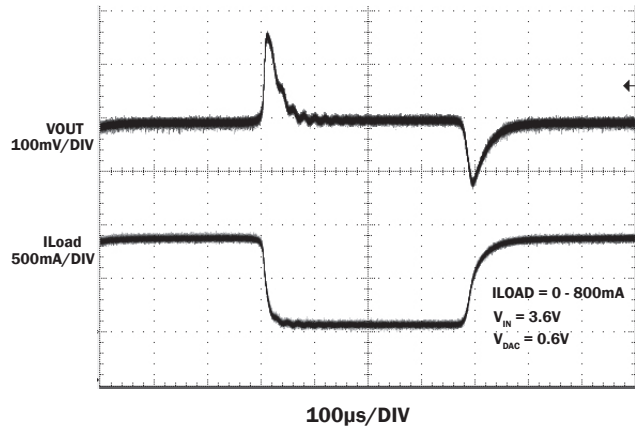

V<sub>DAC</sub> Step Response (Passthrough)

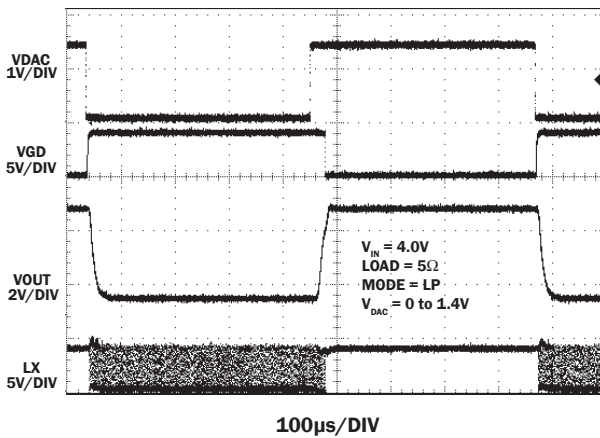

V<sub>DAC</sub> Step Response (100% duty)

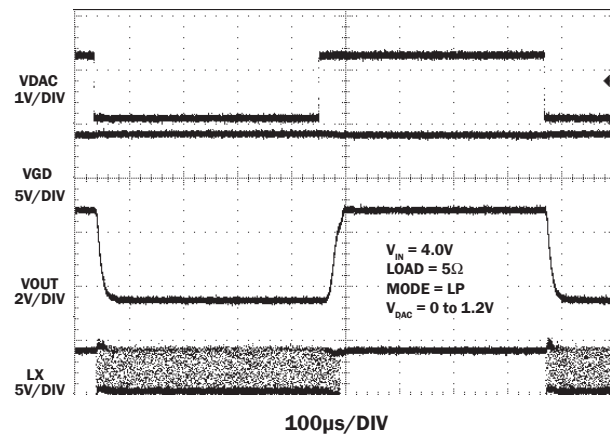

V<sub>DAC</sub> Step Response

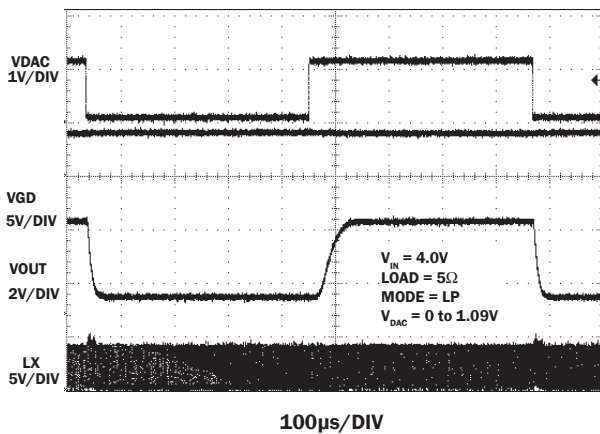

V<sub>MODE</sub> Step Response

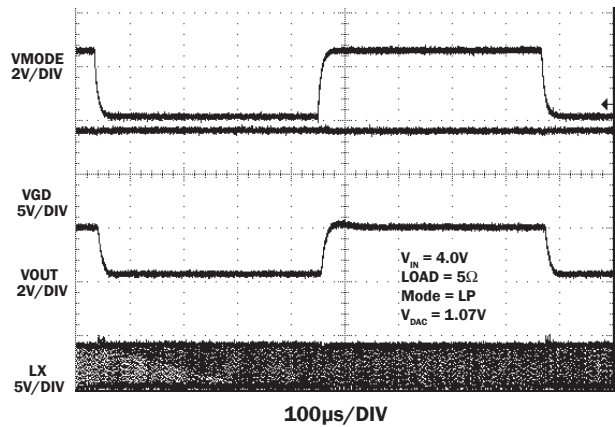



POWER MANAGEMENT

Typical Characteristics (Cont.)

Passthrough Current Limit Operation

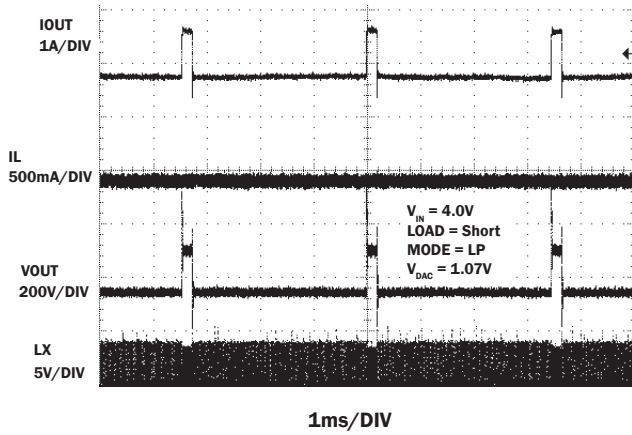

Enable Step Response

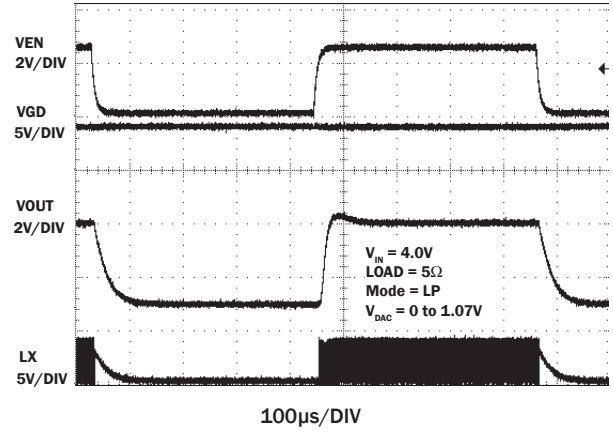

Output Ripple Waveform

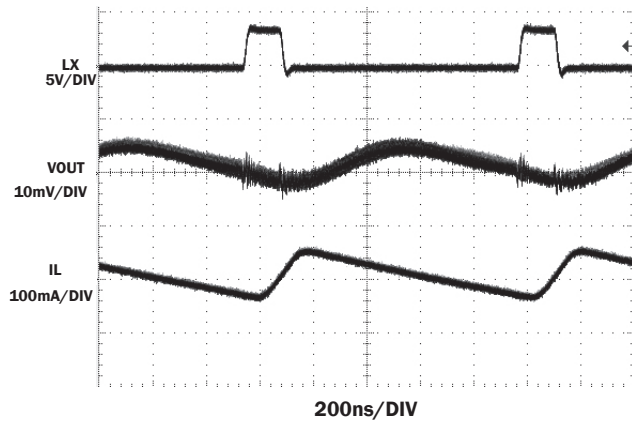

POWER MANAGEMENT

Outline Drawing - MLP-10 3x3

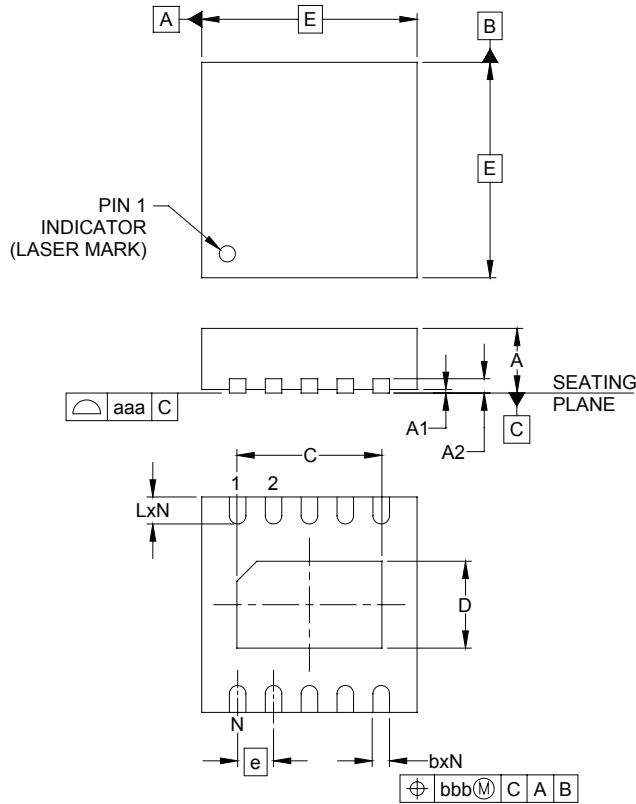

DIM	INCHES			MILLIMETERS		
	MIN	NOM	MAX	MIN	NOM	MAX
A	.031	-	.039	0.80	-	1.00
A1	.000	-	.002	0.00	-	0.05
A2	-	(.008)	-	-	(0.20)	-
b	.007	.009	.011	0.18	0.23	0.30
C	.074	.079	.083	1.87	2.02	2.12
D	.042	.048	.052	1.06	1.21	1.31
E	.114	.118	.122	2.90	3.00	3.10
e	.020 BSC			0.50 BSC		
L	.012	.016	.020	0.30	0.40	0.50
N	10			10		
aaa	.003			0.08		
bbb	.004			0.10		

- NOTES:
1. CONTROLLING DIMENSIONS ARE IN MILLIMETERS (ANGLES IN DEGREES).
  2. COPLANARITY APPLIES TO THE EXPOSED PAD AS WELL AS TERMINALS.

**POWER MANAGEMENT**

**Land Pattern - MLP-10 3x3**

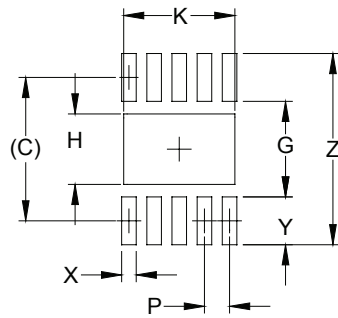

DIMENSIONS		
DIM	INCHES	MILLIMETERS
C	(.112)	(2.85)
G	.075	1.90
H	.055	1.40
K	.087	2.20
P	.020	0.50
X	.012	0.30
Y	.037	0.95
Z	.150	3.80

NOTES:

1. THIS LAND PATTERN IS FOR REFERENCE PURPOSES ONLY. CONSULT YOUR MANUFACTURING GROUP TO ENSURE YOUR COMPANY'S MANUFACTURING GUIDELINES ARE MET.

**Contact Information**

Semtech Corporation  
 Power Management Products Division  
 200 Flynn Road, Camarillo, CA 93012  
 Phone: (805) 498-2111 Fax: (805) 498-3804

[www.semtech.com](http://www.semtech.com)