

OUTLINE

The R1210Nxx1x Series are CMOS-based PWM step-up DC/DC Converter, with high accuracy, low supply current.

Each of the R1210Nxx1x Series consists of an oscillator, a PWM circuit, a reference voltage unit, an error amplifier, phase compensation circuit, resistors for voltage detection, a chip enable circuit. Further, includes a controller against drastic load transient, a control transistor with low ON-Resistance, 'Lx switch', and a protection circuit for Lx switch and an output voltage detector. R1210Nxx1A Series contain further a circuit for changeover oscillator frequency each. A low ripple, high efficiency step-up DC/DC converter can be composed of this IC with only three external components, or an inductor, a diode and a capacitor.

The R1210N Series can detect drastic change of output voltage with a circuit controller. The load transient response is improved compared with current model, furthermore the R1210Nxx1A Series have another function, that is, when the load current is small, oscillator frequency is decreased by a circuit for switching oscillator frequency from Typ. 100kHz to 35kHz, therefore, supply current is reduced.

The built-in chip enable circuit can make the standby mode with ultra low quiescent current.

Since the package for these ICs is small SOT-23-5, high density mounting of the ICs on board is possible.

FEATURES

- External Components Only an inductor, a diode, and a capacitor
- Standby Current Max. 0.5 μ A
- Low Temperature-Drift Coefficient of Output Voltage Typ. \pm 100ppm/ $^{\circ}$ C
- Output Voltage Stepwise Setting with a step of 0.1V in the range of 2.2V to 6.0V (xx1C/D), 2.2V to 3.5V (xx1A)
- Two choices of Basic Oscillator Frequency 100kHz (xx1A/C), 180kHz (xx1D)
- Output Voltage Accuracy..... \pm 2.5%
- Small Package SOT-23-5 (Mini-mold)
- High Efficiency Typ. 88% (V_{IN} =Set Output Voltage \times 0.6 [V], I_{OUT} =10mA)
- Low Ripple, Low Noise
- Built-in a driver transistor with low on-resistance
- Start-up Voltage..... Max. 0.9V
- Basic Frequency change-over circuit (only for xx1A type) from Typ. 100kHz to 35kHz

APPLICATIONS

- Power source for battery-powered equipment.
- Power source for portable communication appliances, cameras, VCRs
- Power source for appliances of which require higher voltage than battery voltage.

BLOCK DIAGRAMS

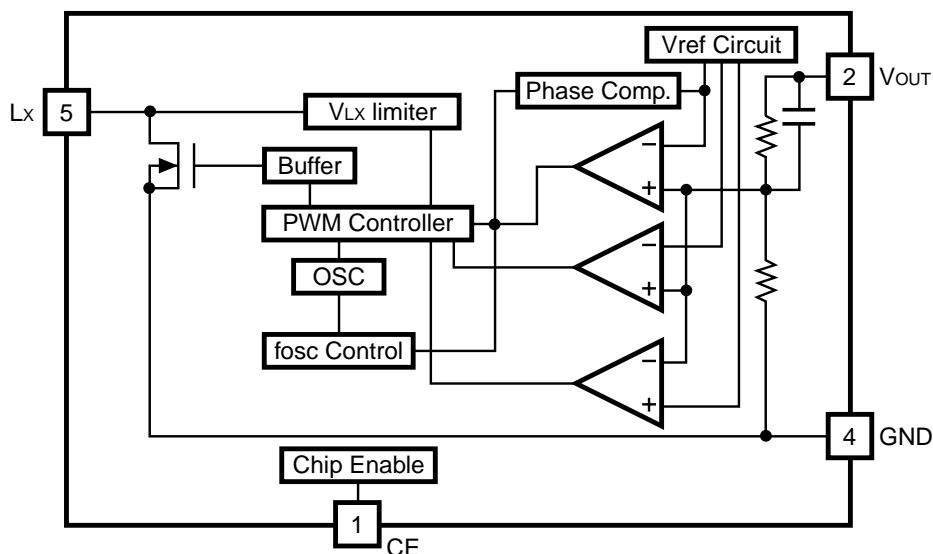

SELECTION GUIDE

In the R1210N Series, the output voltage, the oscillator frequency, the optional function, and the taping type for the ICs can be selected at the user's request.

The selection can be made by designating the part number as shown below ;

R1210N $\overset{\uparrow}{a}$ $\overset{\uparrow}{b}$ $\overset{\uparrow}{c}$ $\overset{\uparrow}{d}$ $\overset{\uparrow}{e}$ xx1x-xx-F ←Part Number

Code	Contents
a	Designation of Package Type: N: SOT-23-5
b	Setting Output Voltage (V_{out}) : Stepwise setting with a step of 0.1V in the range of 2.2V to 6.0V (for xx1C/D version) or 2.2V to 3.5V (for xx1A version) is possible.
c	Designation of Oscillator Frequency A : 100kHz with a Frequency Change-over circuit C : 100kHz without a Frequency Change-over circuit D : 180kHz without a Frequency Change-over circuit
d	Designation of Taping Type: Ex. TR (Refer to Taping Specifications; TR type is the standard direction.)
e	Designation of composition of pin plating: -F: Lead free plating

PIN CONFIGURATIONS

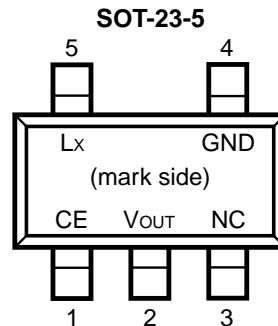

PIN DESCRIPTIONS

Pin No	Symbol	Pin Description
1	CE	Chip Enable Pin
2	V _{OUT}	Pin for Monitoring Output Voltage
3	NC	No Connection
4	GND	Ground Pin
5	Lx	Switching Pin (Nch Open Drain)

ABSOLUTE MAXIMUM RATINGS

Symbol	Item	Rating	Unit
V _{OUT}	V _{OUT} Pin Output Voltage	-0.3 to 9.0	V
V _{LX}	Lx Pin Output Voltage	-0.3 to 9.0	V
V _{CE}	CE Pin Input Voltage	-0.3 to 9.0	V
I _{LX}	Lx Pin Output Current	400	mA
P _D	Power Dissipation	420	mW
T _{opt}	Operating Temperature Range	-40 to +85	°C
T _{stg}	Storage Temperature Range	-55 to +125	°C

*1) For Power Dissipation, please refer to PACKAGE INFORMATION to be described.

ELECTRICAL CHARACTERISTICS

• R1210Nxx1x

T_{opt}=25°C

Symbol	Item	Conditions	Min.	Typ.	Max.	Unit
V _{OUT}	Output Voltage	V _{IN} =V _{SET} ×0.6, I _{OUT} =1mA	×0.975		×1.025	V
V _{IN}	Maximum Input Voltage				8	V
$\frac{\Delta V_{OUT}}{\Delta T_{opt}}$	Step-up Output Voltage Temperature Coefficient	-40°C ≤ T _{opt} ≤ 85°C		±100		ppm/°C
V _{start}	Start-up Voltage	V _{IN} =0V→2V, V _{OUT} :1.8kΩ pull-down			0.9	V
$\frac{\Delta V_{start}}{\Delta T_{opt}}$	Start-up Voltage Temperature Coefficient	-40°C ≤ T _{opt} ≤ 85°C		-3.2		mV/°C
V _{hold}	Hold-on Voltage	V _{IN} =2.0V→0V, I _{OUT} =1mA	0.7			V (xx1A/C)
			0.9			V (xx1D)
I _{DD1}	Supply Current 1	2.2V ≤ V _{SET} ≤ 2.5V V _{OUT} = V _{SET} ×0.96		30	55	μA (xx1A/C)
				50	80	μA (xx1D)
		2.6V ≤ V _{SET} ≤ 3.0V V _{OUT} = V _{SET} ×0.96		35	60	μA (xx1A/C)
				60	90	μA (xx1D)
		3.1V ≤ V _{SET} ≤ 3.5V V _{OUT} = V _{SET} ×0.96		40	70	μA (xx1A/C)
				70	100	μA (xx1D)
		3.6V ≤ V _{SET} ≤ 4.0V V _{OUT} = V _{SET} ×0.96		45	80	μA (xx1C)
				80	110	μA (xx1D)
		4.1V ≤ V _{SET} ≤ 4.5V V _{OUT} = V _{SET} ×0.96		50	90	μA (xx1C)
				90	120	μA (xx1D)
		4.6V ≤ V _{SET} ≤ 5.0V V _{OUT} = V _{SET} ×0.96		70	100	μA (xx1C)
				100	130	μA (xx1D)
		5.1V ≤ V _{SET} ≤ 5.5V V _{OUT} = V _{SET} ×0.96		80	110	μA (xx1C)
				110	150	μA (xx1D)
		5.6V ≤ V _{SET} ≤ 6.0V V _{OUT} = V _{SET} ×0.96		90	120	μA (xx1C)
				120	170	μA (xx1D)

Symbol	Item	Conditions	Min.	Typ.	Max.	Unit
I _{DD2}	Supply Current 2	V _{OUT} =V _{CE} =V _{SET} +0.5V		10	17	μA (xx1A/C)
				15	24	μA (xx1D)
I _{standby}	Standby Current	V _{OUT} =6.5V, V _{CE} =0V			0.5	μA
I _{LXleak}	L _X Leakage Current	V _{OUT} =V _{LX} =8V			0.5	μA
f _{osc}	Maximum Oscillator Frequency	V _{OUT} =V _{CE} =V _{SET} ×0.96	80	100	120	kHz (xx1A/C)
			144	180	216	kHz (xx1D)
Δ f _{osc} / Δ T _{opt}	Oscillator Frequency Temperature Coefficient	-40°C ≤ T _{opt} ≤ 85°C		0.5		KHz/°C (xx1A/C)
				0.6		KHz/°C (xx1D)
Maxdty	Oscillator Maximum Duty Cycle	V _{OUT} =V _{CE} =V _{SET} ×0.96, (V _{LX} "L" Side)	70	85	97	%
V _{LXlim}	V _{LX} Limit Voltage	V _{OUT} =V _{CE} =V _{SET} ×0.96, (V _{LX} "L" Side)	0.4	0.6	0.8	V
V _{CEH}	CE "H" Input Voltage	V _{OUT} =V _{SET} ×0.96	0.9			V
V _{CEL}	CE "L" Input Voltage	V _{OUT} =V _{SET} ×0.96			0.3	V
I _{CEH}	CE "H" Input Current	V _{OUT} =V _{CE} =6.5V	-0.1	0	0.1	μA
I _{CEL}	CE "L" Input Current	V _{IN} =6.5V, V _{CE} =0V	-0.1	0	0.1	μA
I _{LX}	L _X Switching Current	2.2V ≤ V _{SET} ≤ 2.4V V _{LX} =0.4V	70			mA
		2.5V ≤ V _{SET} ≤ 2.9V V _{LX} =0.4V	85			mA
		3.0V ≤ V _{SET} ≤ 3.4V V _{LX} =0.4V	100			mA
		3.5V ≤ V _{SET} ≤ 3.9V V _{LX} =0.4V	120			mA
		4.0V ≤ V _{SET} ≤ 4.4V V _{LX} =0.4V	140			mA
		4.5V ≤ V _{SET} ≤ 4.9V V _{LX} =0.4V	150			mA
		5.0V ≤ V _{SET} ≤ 5.4V V _{LX} =0.4V	170			mA
		5.5V ≤ V _{SET} ≤ 6.0V V _{LX} =0.4V	190			mA
f _{osc2}	Change-over frequency	V _{IN} =V _{SET} ×0.6, I _{OUT} =0.5mA (only for xx1A)	10	35	70	kHz

*Note: V_{SET} means setting Output Voltage.

TEST CIRCUITS

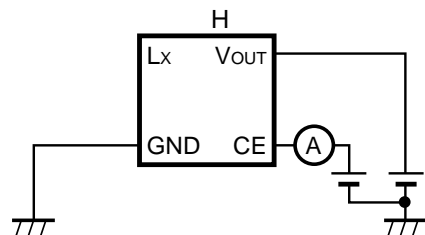
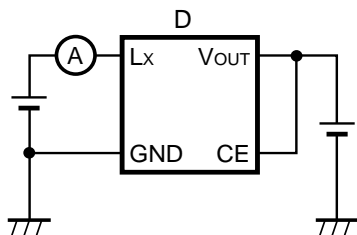
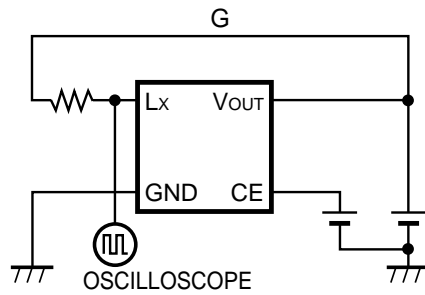
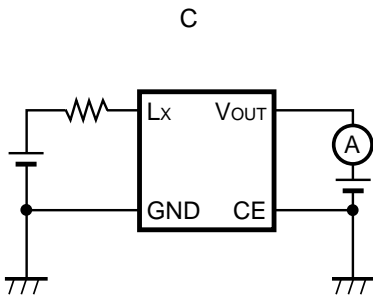
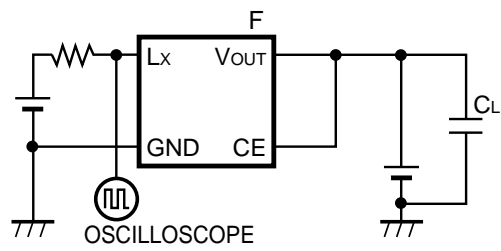
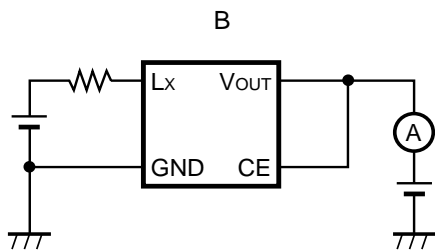
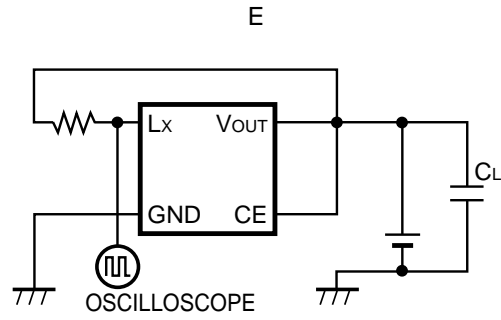
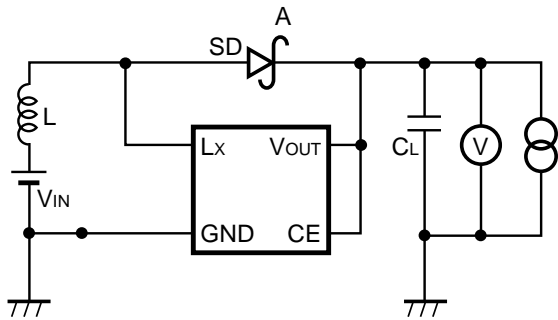

L: 100 μ H CD54 (Sumida Electric Co, LTD)
 SD: MA721 (Matsushita Electronics Corporation, Schottky Type)
 CL: 22 μ F \times 2 (Tantalum Type)

TYPICAL CHARACTERISTICS

1) Output Voltage vs. Output Current

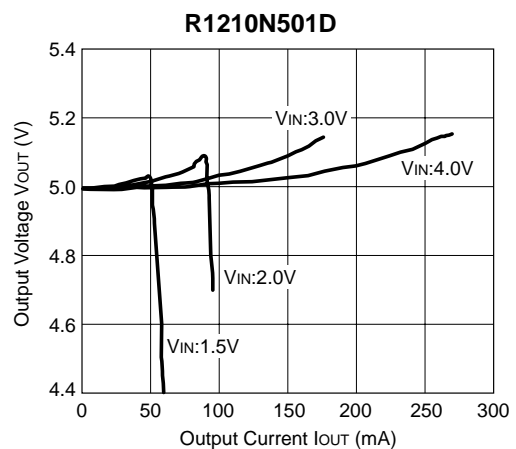
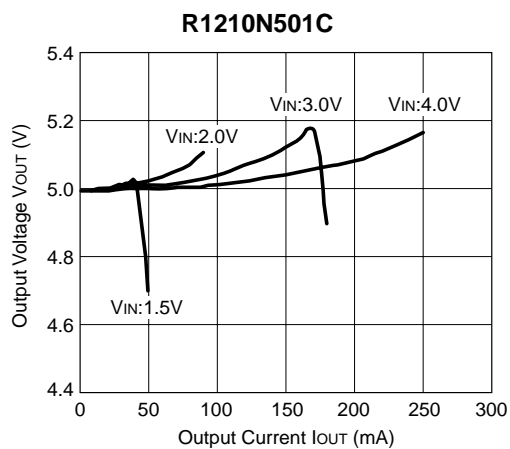
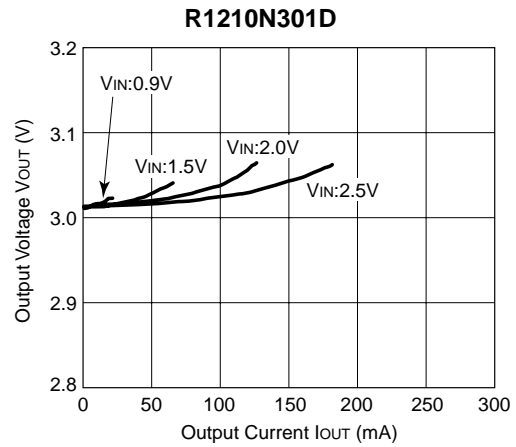
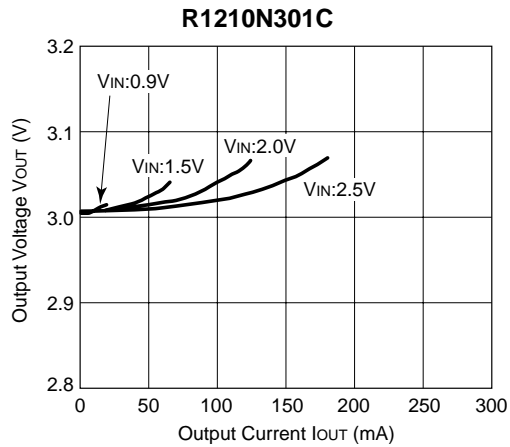

2) Efficiency vs. Output Current

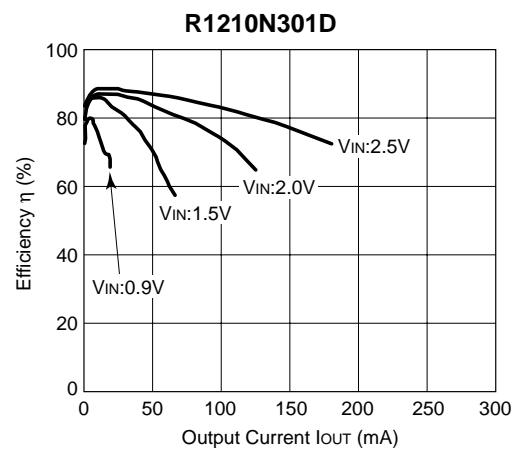
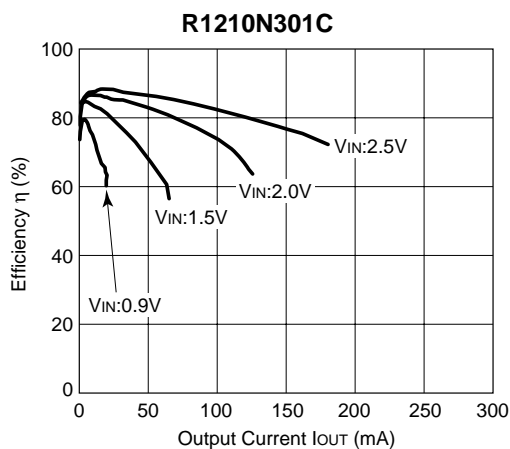

R1210Nxx1x

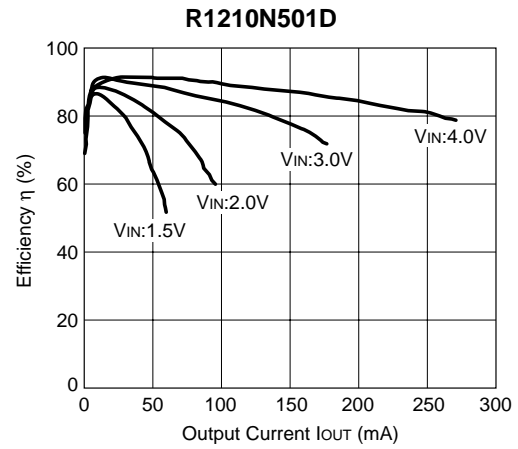
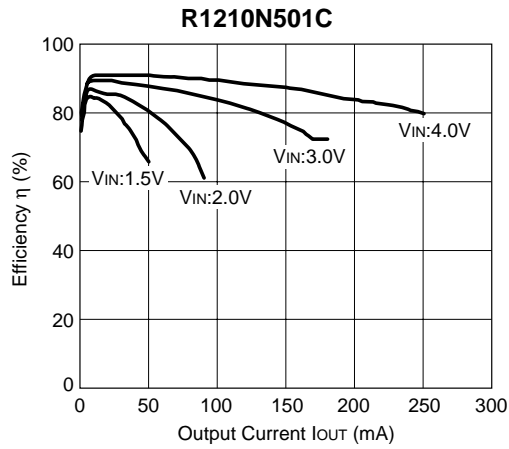

3) R1210Nxx1A/C Efficiency

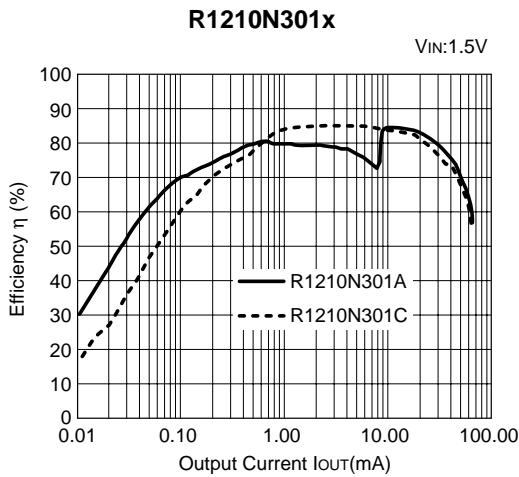

4) Ripple Voltage vs. Output Current

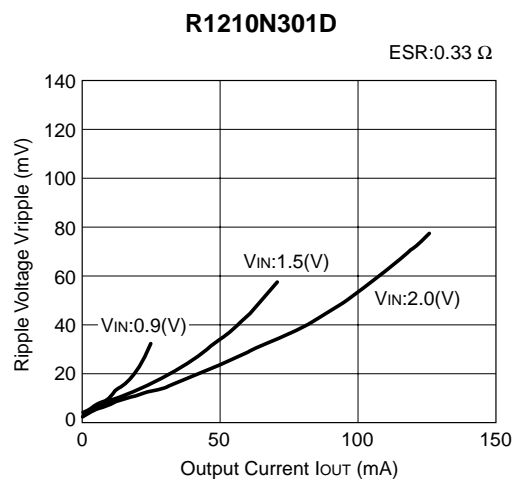
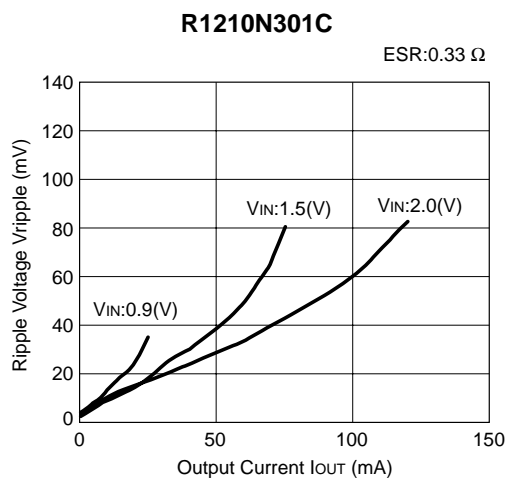

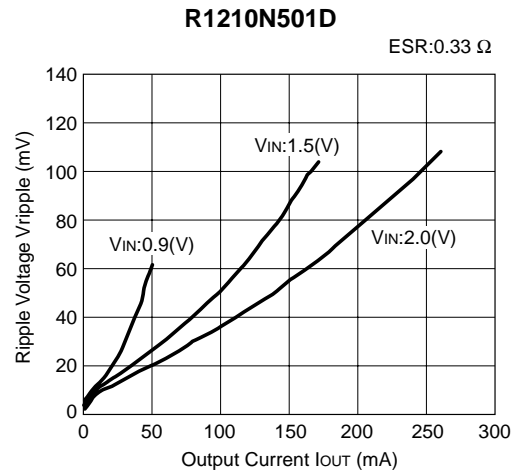
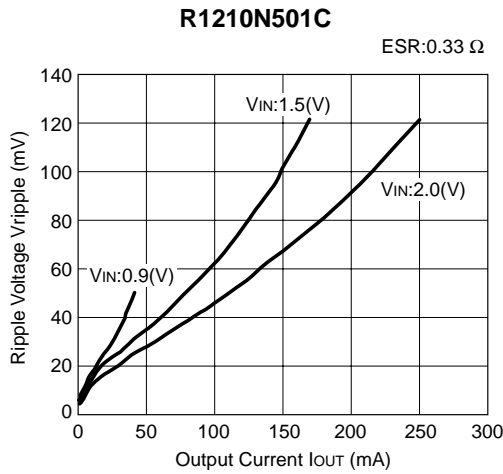

5) Start-up Voltage/Hold-on Voltage vs. Output Current (Topt=25°C)

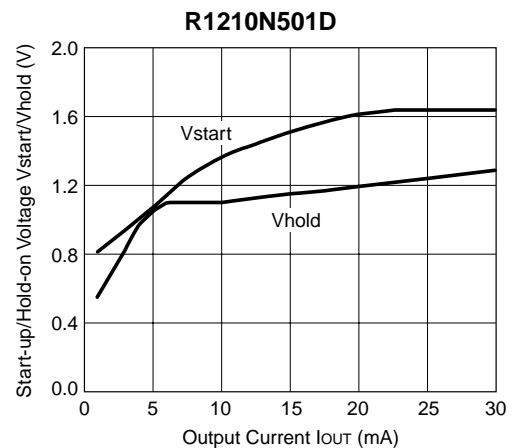
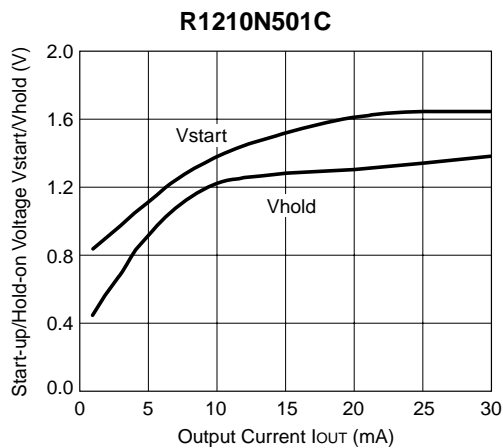
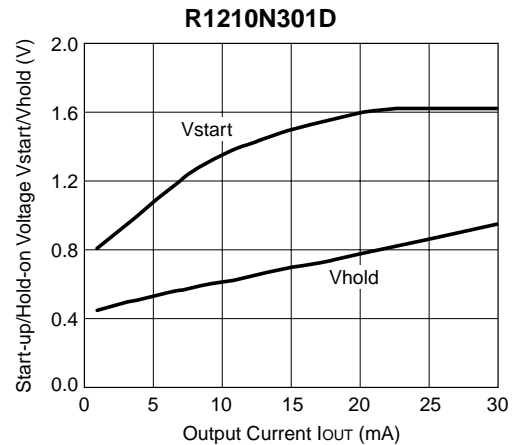
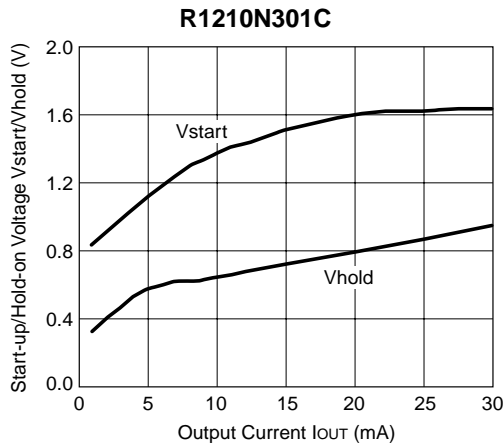

6) Output Voltage vs. Temperature

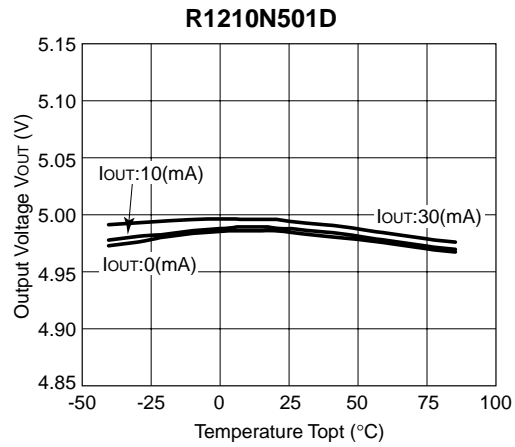
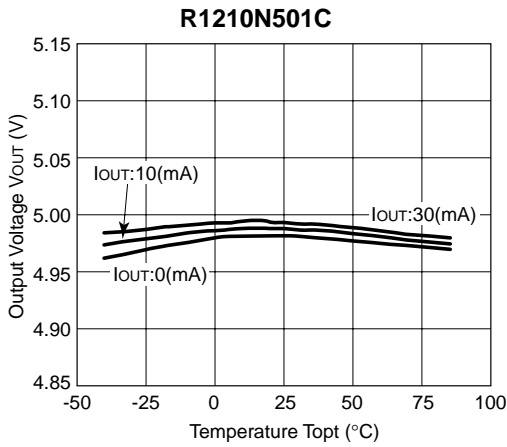
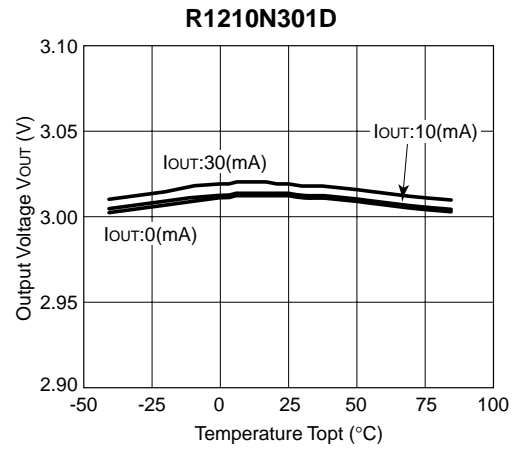
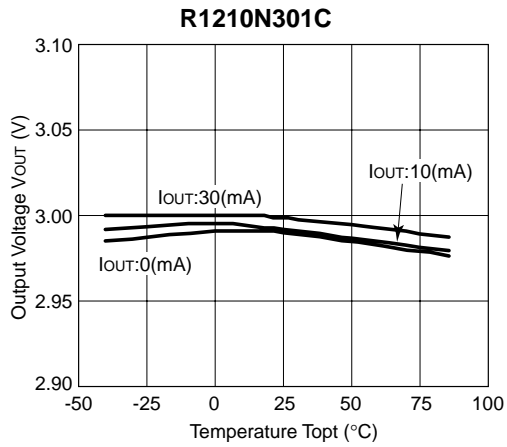

7) Supply Current 1 vs. Temperature

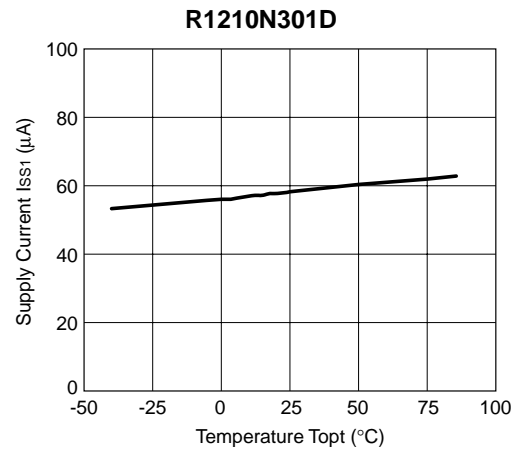
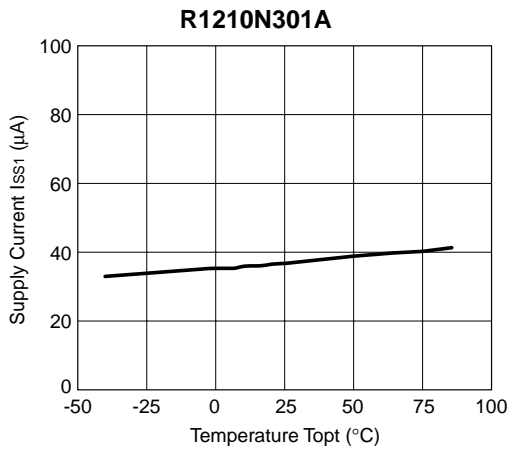

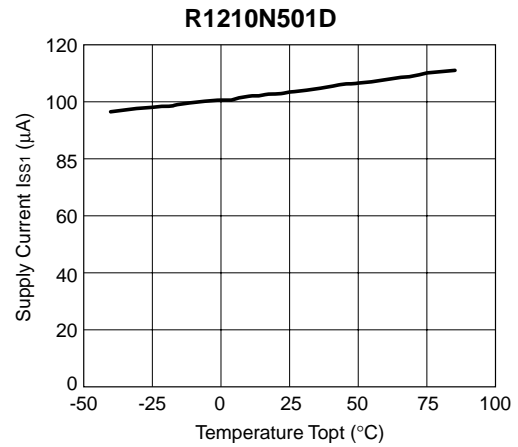
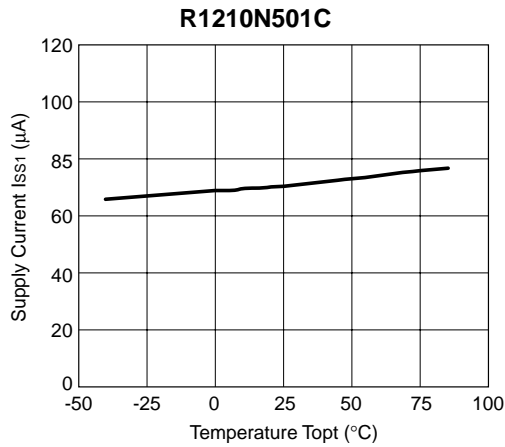

8) Supply Current2 vs. Temperature

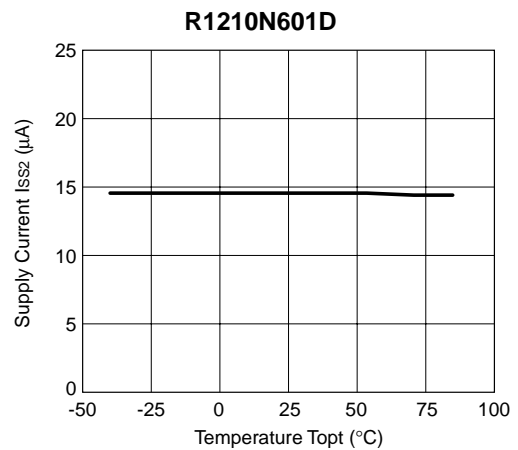
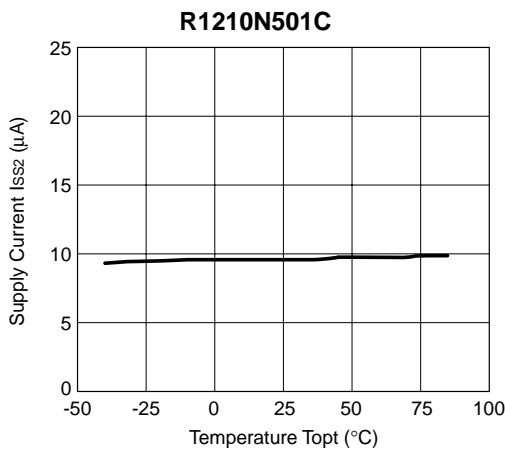
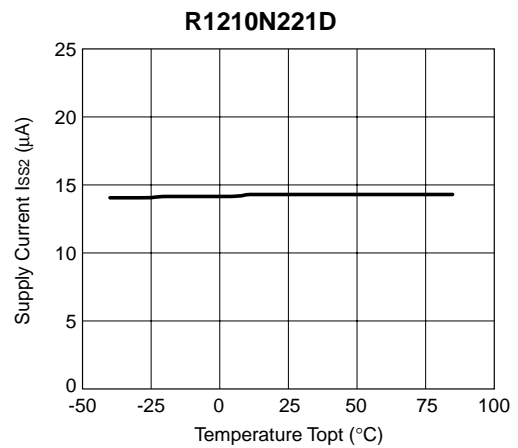
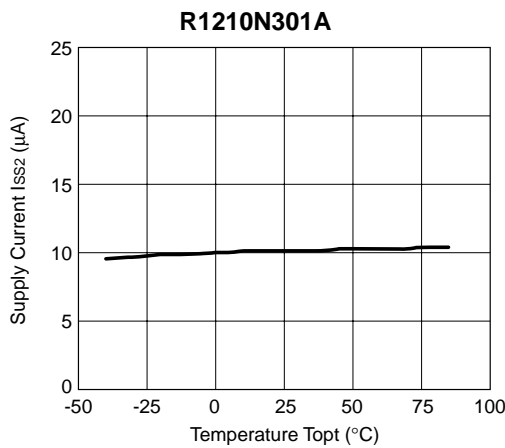

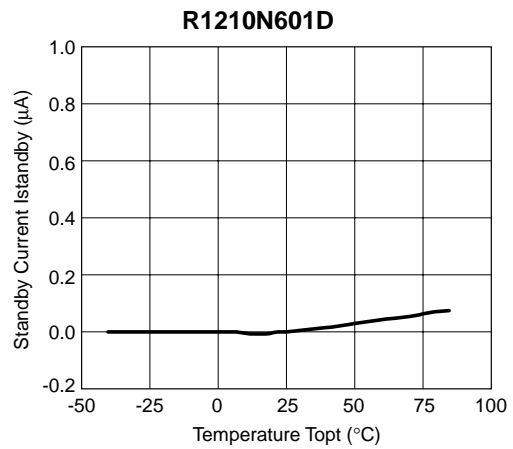
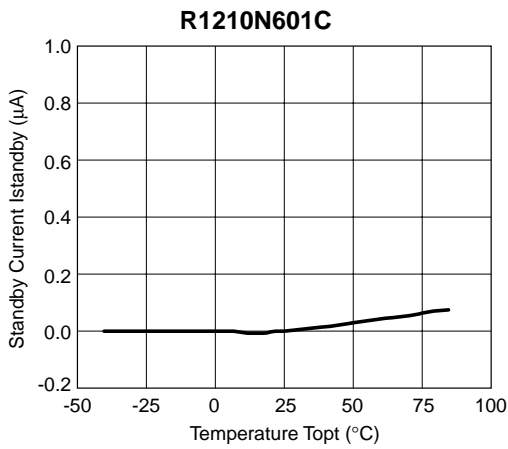
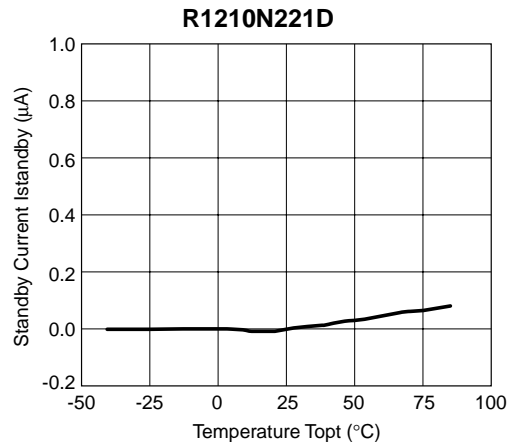
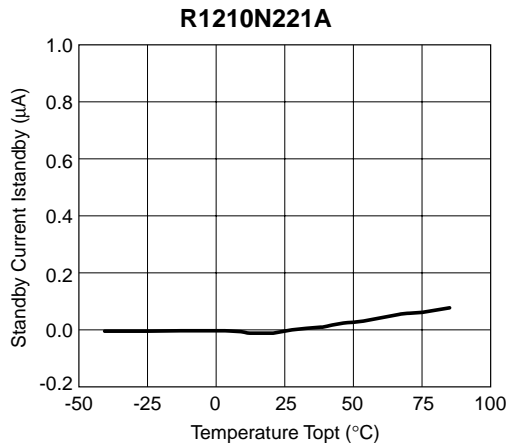
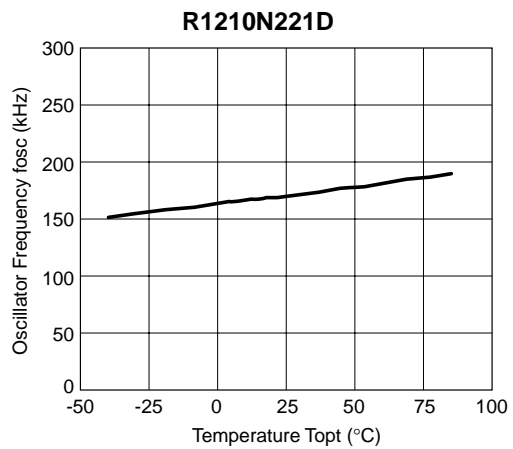
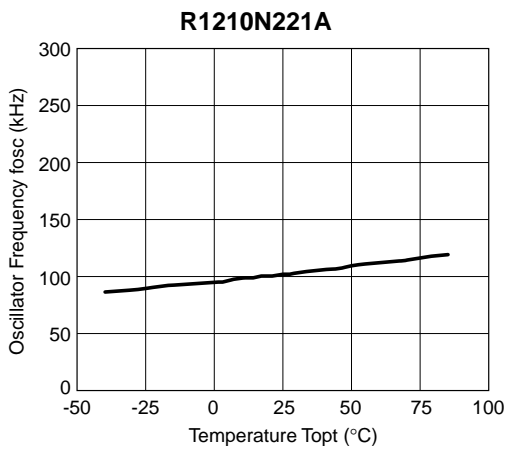
9) Standby Current vs. Temperature**10) Oscillator Frequency vs. Temperature**

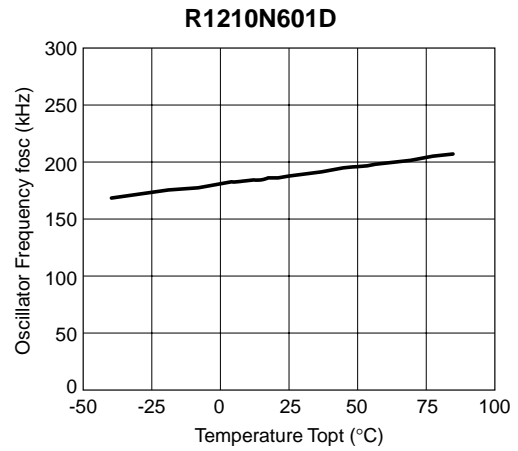
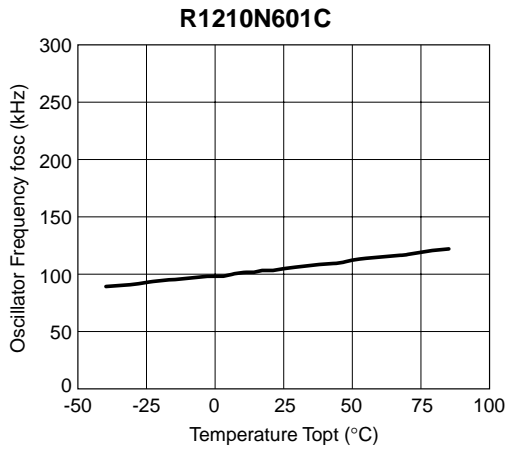

11) Maximum Duty Cycle vs. Temperature

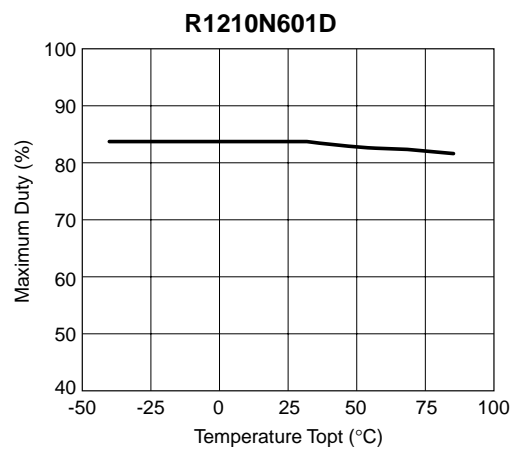
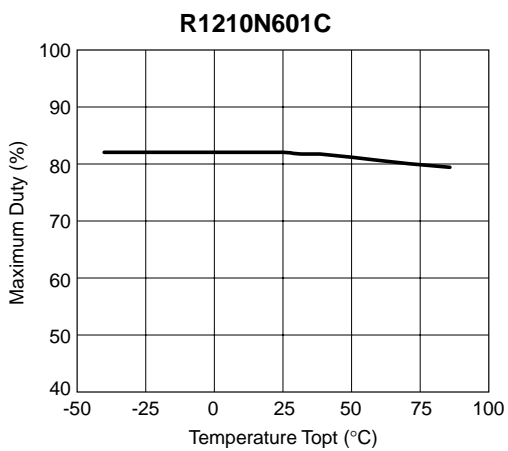
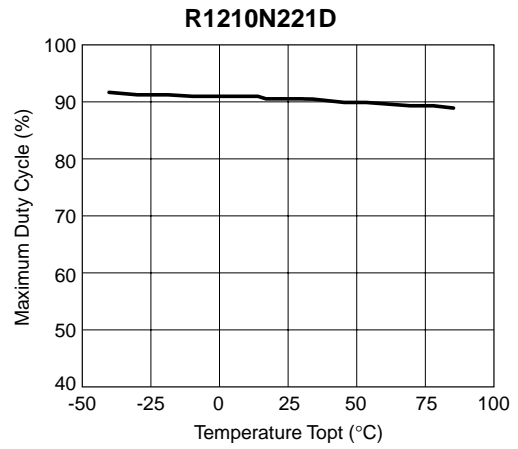
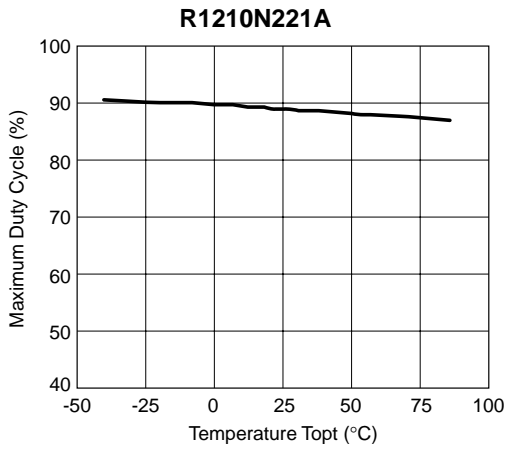

12) L_x Switching Current vs. Temperature

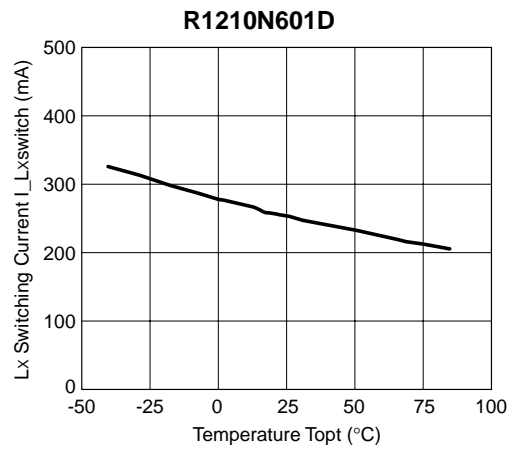
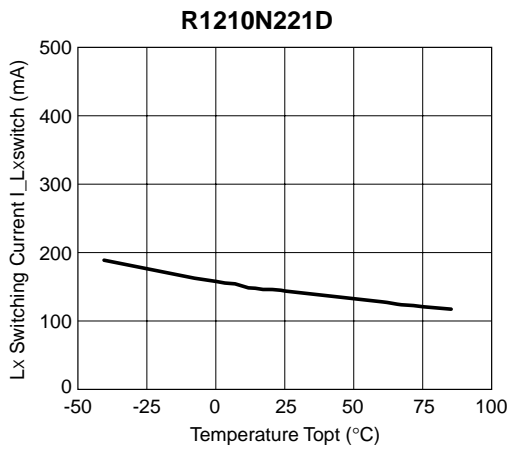
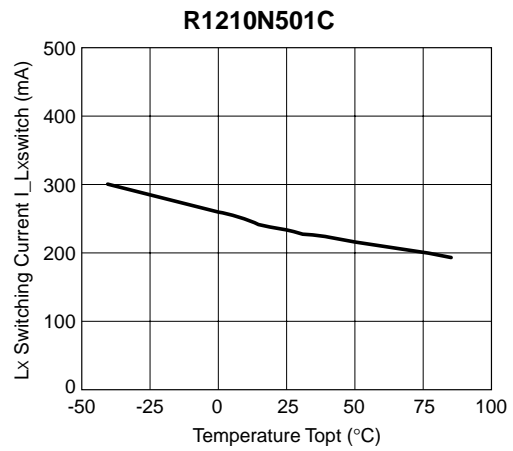
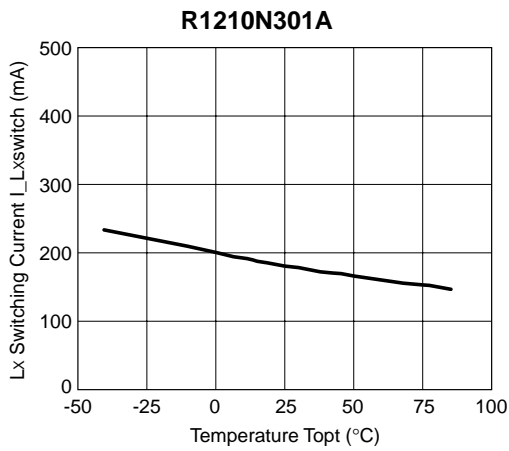

13) L_x leakage Current vs. Temperature

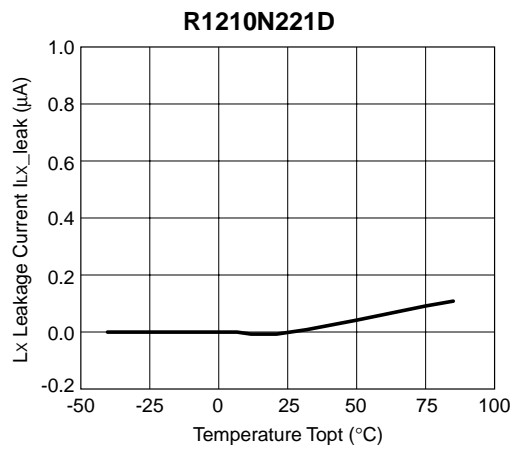
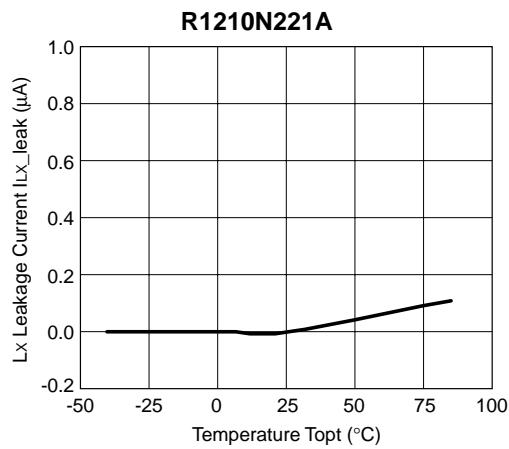

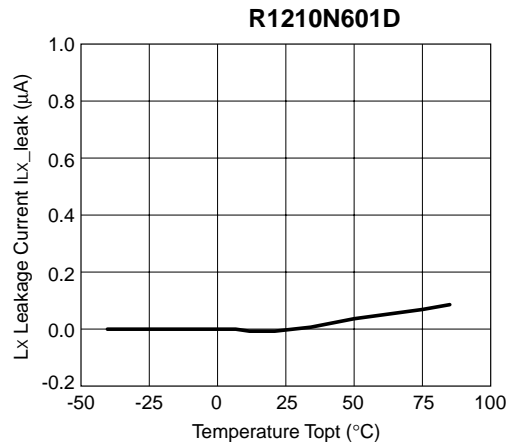
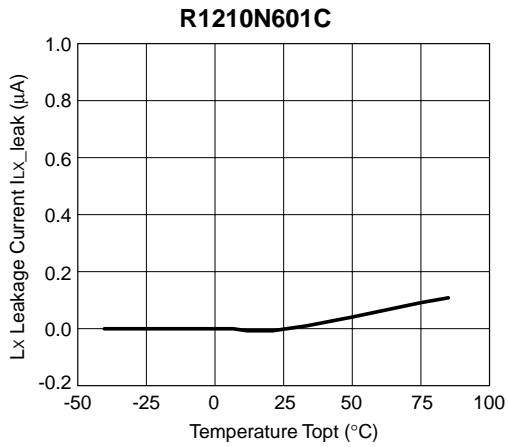

14) VL_x Voltage Limit vs. Temperature

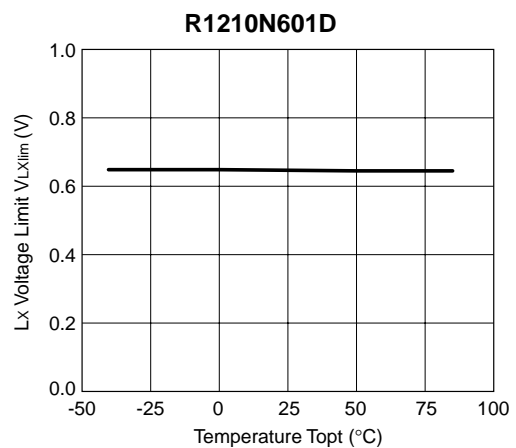
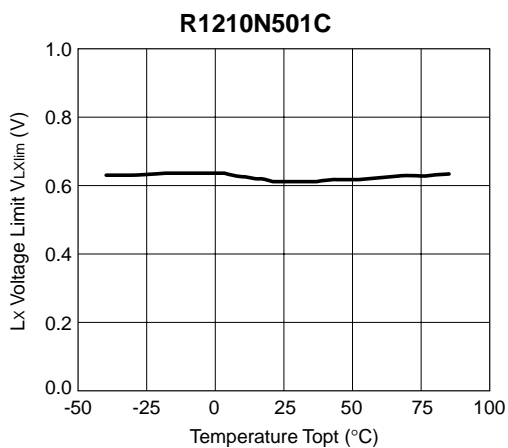
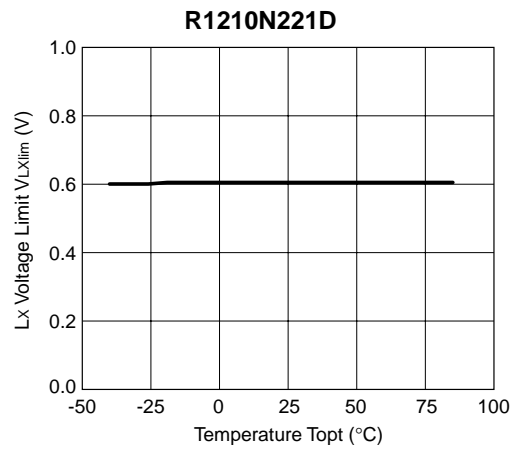
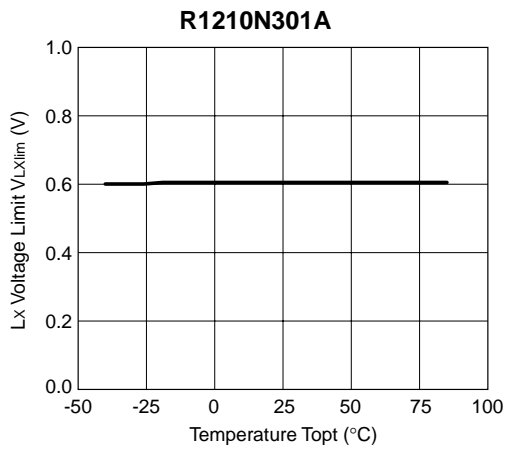

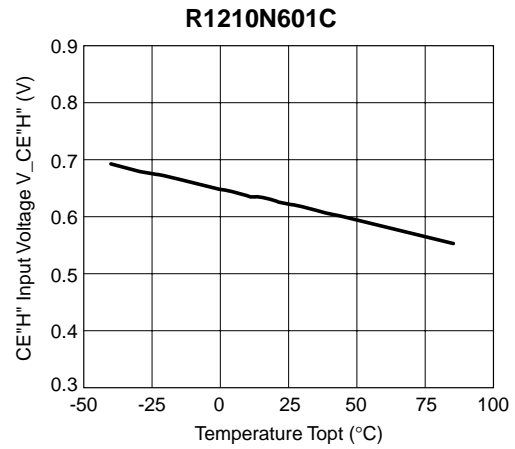
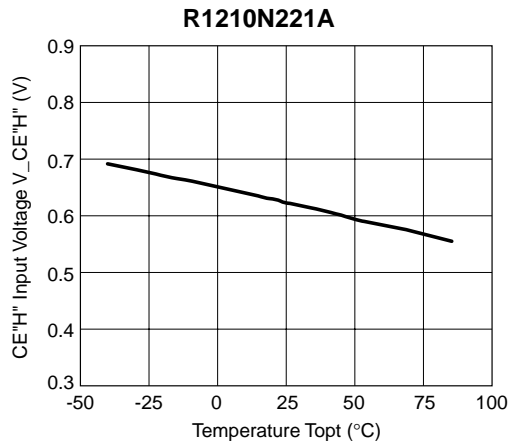
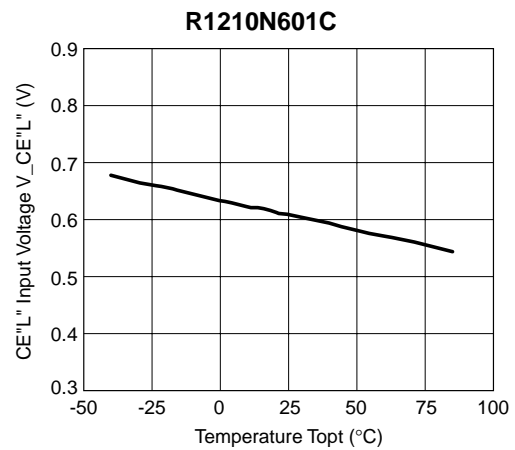
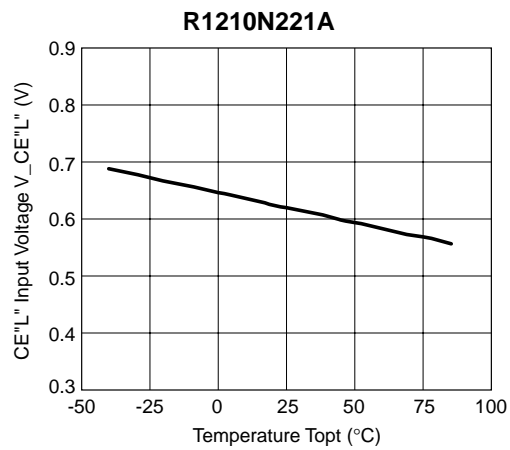
15) CE "H" Input Voltage vs. Temperature**16) CE "L" Input Voltage vs. Temperature**

- SOT-23-5 (SC-74A)

Unit: mm

PACKAGE DIMENSIONS

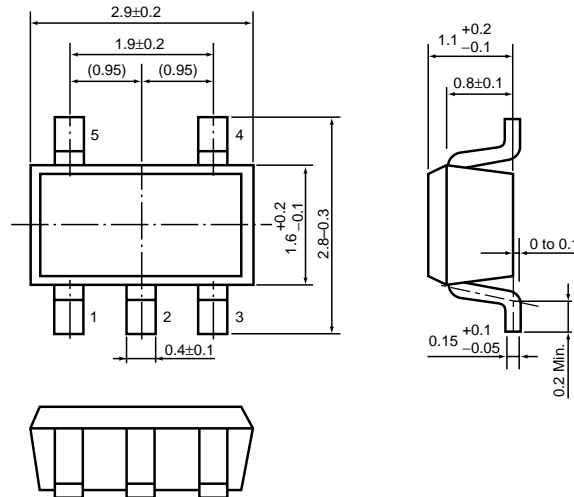

TAPING SPECIFICATION

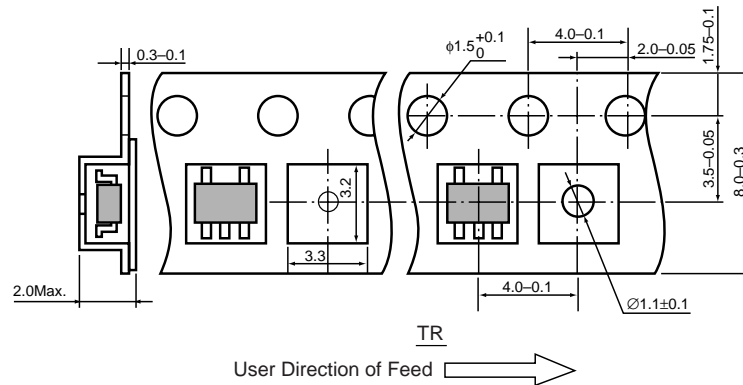

TAPING REEL DIMENSIONS REUSE REEL (EIAJ-RRM-08Bc)

(1reel=3000pcs)

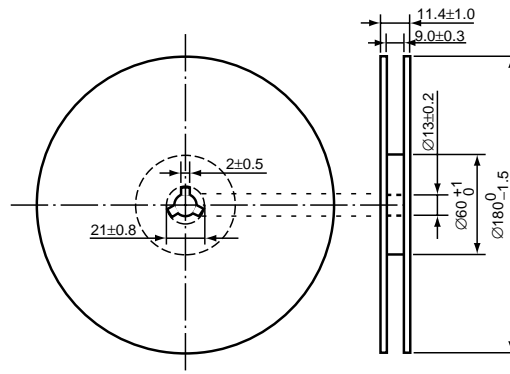

POWER DISSIPATION (SOT-23-5)

This specification is at mounted on board. Power Dissipation (P_D) depends on conditions of mounting on board. This specification is based on the measurement at the condition below: (Power Dissipation (SOT-23-5) is substitution of SOT-23-6.)

Measurement Conditions

	Standard Land Pattern
Environment	Mounting on Board (Wind velocity=0m/s)
Board Material	Glass cloth epoxy plastic (Double sided)
Board Dimensions	40mm × 40mm × 1.6mm
Copper Ratio	Top side : Approx. 50% , Back side : Approx. 50%
Through-hole	φ0.5mm × 44pcs

Measurement Result

($T_{opt}=25^{\circ}C$, $T_{jmax}=125^{\circ}C$)

	Standard Land Pattern	Free Air
Power Dissipation	420mW	250mW
Thermal Resistance	$\theta_{ja}=(125-25^{\circ}C)/0.42W=238^{\circ}C/W$	400 $^{\circ}C/W$

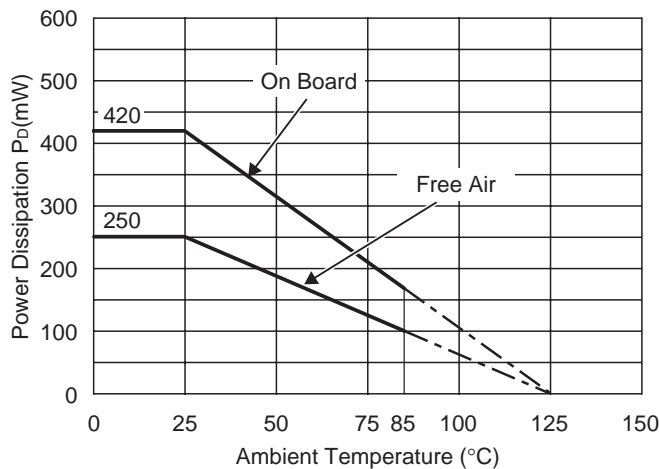

Power Dissipation

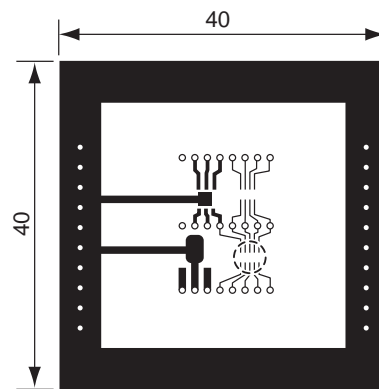

Measurement Board Pattern

○ IC Mount Area Unit : mm

RECOMMENDED LAND PATTERN

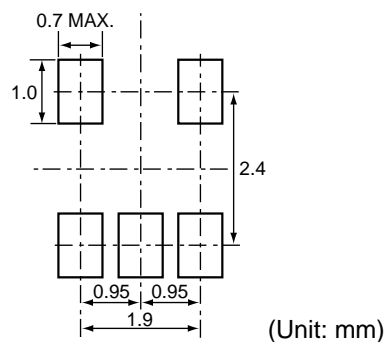

R1210N SERIES MARK SPECIFICATION

● SOT-23-5 (SC-74A)

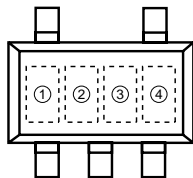

①, ② : Product Code (refer to Part Number vs. Product Code)

③, ④ : Lot Number

● Part Number vs. Product Code

Part Number	Product Code	
	①	②
R1210N221A	2	Q
R1210N231A	3	Q
R1210N241A	4	Q
R1210N251A	5	Q
R1210N261A	6	Q
R1210N271A	7	Q
R1210N281A	8	Q
R1210N291A	9	Q
R1210N301A	0	R
R1210N311A	1	R
R1210N321A	2	R
R1210N331A	3	R
R1210N341A	4	R
R1210N351A	5	R
R1210N221C	2	U
R1210N231C	3	U
R1210N241C	4	U
R1210N251C	5	U
R1210N261C	6	U
R1210N271C	7	U
R1210N281C	8	U
R1210N291C	9	U
R1210N301C	0	W
R1210N311C	1	W
R1210N321C	2	W
R1210N331C	3	W
R1210N341C	4	W
R1210N351C	5	W
R1210N361C	6	W
R1210N371C	7	W
R1210N381C	8	W
R1210N391C	9	W
R1210N401C	0	X
R1210N411C	1	X
R1210N421C	2	X
R1210N431C	3	X
R1210N441C	4	X
R1210N451C	5	X
R1210N461C	6	X
R1210N471C	7	X
R1210N481C	8	X
R1210N491C	9	X
R1210N501C	0	Y

Part Number	Product Code	
	①	②
R1210N511C	1	Y
R1210N521C	2	Y
R1210N531C	3	Y
R1210N541C	4	Y
R1210N551C	5	Y
R1210N561C	6	Y
R1210N571C	7	Y
R1210N581C	8	Y
R1210N591C	9	Y
R1210N601C	X	W
R1210N221D	2	Z
R1210N231D	3	Z
R1210N241D	4	Z
R1210N251D	5	Z
R1210N261D	6	Z
R1210N271D	7	Z
R1210N281D	8	Z
R1210N291D	9	Z
R1210N301D	W	0
R1210N311D	W	1
R1210N321D	W	2
R1210N331D	W	3
R1210N341D	W	4
R1210N351D	W	5
R1210N361D	W	6
R1210N371D	W	7
R1210N381D	W	8
R1210N391D	W	9
R1210N401D	W	A
R1210N411D	W	B
R1210N421D	W	C
R1210N431D	W	D
R1210N441D	W	E
R1210N451D	W	F
R1210N461D	W	G
R1210N471D	W	H
R1210N481D	W	J
R1210N491D	W	K
R1210N501D	4	V
R1210N511D	W	M
R1210N521D	W	N
R1210N531D	W	P
R1210N541D	W	Q

Part Number	Product Code	
	①	②
R1210N551D	W	R
R1210N561D	W	S
R1210N571D	W	T
R1210N581D	W	U
R1210N591D	W	V
R1210N601D	Y	W
R1210N222C	X	2
R1210N232C	X	3
R1210N242C	X	4
R1210N252C	X	5
R1210N262C	X	6
R1210N272C	X	7
R1210N282C	X	8
R1210N292C	X	9
R1210N302C	X	A
R1210N312C	X	B
R1210N322C	X	C
R1210N332C	X	D
R1210N342C	X	E
R1210N352C	X	F
R1210N362C	X	G
R1210N372C	X	H
R1210N382C	X	J
R1210N392C	X	K
R1210N402C	X	L
R1210N412C	X	M
R1210N422C	X	N
R1210N432C	X	P
R1210N442C	X	Q
R1210N452C	X	R
R1210N462C	X	S
R1210N472C	X	T
R1210N482C	X	U
R1210N492C	X	V
R1210N502C	Y	0
R1210N512C	Y	1
R1210N522C	Y	2
R1210N532C	Y	3
R1210N542C	Y	4
R1210N552C	Y	5
R1210N562C	Y	6
R1210N572C	Y	7
R1210N582C	Y	8

Part Number	Product Code	
	①	②
R1210N592C	Y	9
R1210N602C	Z	W
R1210N222D	Y	C
R1210N232D	Y	D
R1210N242D	Y	E
R1210N252D	Y	F
R1210N262D	Y	G
R1210N272D	Y	H
R1210N282D	Y	J
R1210N292D	Y	K
R1210N302D	Y	L
R1210N312D	Y	M
R1210N322D	Y	N
R1210N332D	Y	P
R1210N342D	Y	Q
R1210N352D	Y	R
R1210N362D	Y	S
R1210N372D	Y	T
R1210N382D	Y	U
R1210N392D	Y	V
R1210N402D	Z	0
R1210N412D	Z	1
R1210N422D	Z	2
R1210N432D	Z	3
R1210N442D	Z	4
R1210N452D	Z	5
R1210N462D	Z	6
R1210N472D	Z	7
R1210N482D	Z	8
R1210N492D	Z	9
R1210N502D	Z	A
R1210N512D	Z	B
R1210N522D	Z	C
R1210N532D	Z	D
R1210N542D	Z	E
R1210N552D	Z	F
R1210N562D	Z	G
R1210N572D	Z	H
R1210N582D	Z	J
R1210N592D	Z	K
R1210N602D	Z	L