

IRF7507PbF

HEXFET® Power MOSFET

- Generation V Technology
- Ultra Low On-Resistance
- Dual N and P Channel MOSFET
- Very Small SOIC Package
- Low Profile (<1.1mm)
- Available in Tape & Reel
- Fast Switching
- Lead-Free

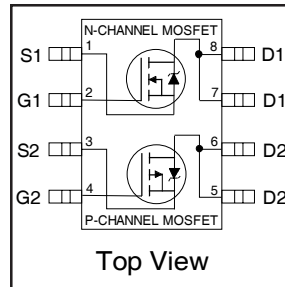

	N-Ch	P-Ch
V_{DS}	20V	-20V
$R_{DS(on)}$	0.135 Ω	0.27 Ω

Description

Fifth Generation HEXFETs from International Rectifier utilize advanced processing techniques to achieve extremely low on-resistance per silicon area. This benefit, combined with the fast switching speed and ruggedized device design that HEXFET Power MOSFETs are well known for, provides the designer with an extremely efficient and reliable device for use in a wide variety of applications.

The new Micro8 package, with half the footprint area of the standard SO-8, provides the smallest footprint available in an SOIC outline. This makes the Micro8 an ideal device for applications where printed circuit board space is at a premium. The low profile (<1.1mm) of the Micro8 will allow it to fit easily into extremely thin application environments such as portable electronics and PCMCIA cards.

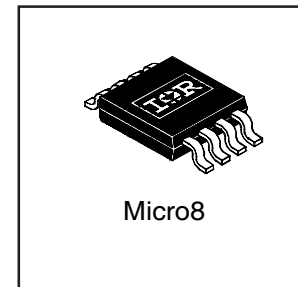

Absolute Maximum Ratings

	Parameter	Max.		Units
		N-Channel	P-Channel	
V_{DS}	Drain-Source Voltage	20	-20	V
$I_D @ T_A = 25^\circ\text{C}$	Continuous Drain Current, V_{GS}	2.4	-1.7	A
$I_D @ T_A = 70^\circ\text{C}$	Continuous Drain Current, V_{GS}	1.9	-1.4	
I_{DM}	Pulsed Drain Current ^①	19	-14	
$P_D @ T_A = 25^\circ\text{C}$	Maximum Power Dissipation ^④	1.25		W
$P_D @ T_A = 70^\circ\text{C}$	Maximum Power Dissipation ^④	0.8		W
	Linear Derating Factor	10		mW/ $^\circ\text{C}$
V_{GS}	Gate-to-Source Voltage	± 12		V
V_{GSM}	Gate-to-Source Voltage Single Pulse $t_p < 10\mu\text{s}$	16		V
dv/dt	Peak Diode Recovery dv/dt ^②	5.0	-5.0	V/ns
T_J, T_{STG}	Junction and Storage Temperature Range	-55 to + 150		$^\circ\text{C}$
	Soldering Temperature, for 10 seconds	240 (1.6mm from case)		

Thermal Resistance

	Parameter	Max.	Units
$R_{\theta JA}$	Maximum Junction-to-Ambient ^④	100	$^\circ\text{C}/\text{W}$

Electrical Characteristics @ T_J = 25°C (unless otherwise specified)

Parameter	Parameter		Min.	Typ.	Max.	Units	Conditions
V _{(BR)DSS}	Drain-to-Source Breakdown Voltage	N-Ch	20	—	—	V	V _{GS} = 0V, I _D = 250μA
		P-Ch	-20	—	—		V _{GS} = 0V, I _D = -250μA
ΔV _{(BR)DSS} /ΔT _J	Breakdown Voltage Temp. Coefficient	N-Ch	—	0.041	—	V/°C	Reference to 25°C, I _D = 1mA
		P-Ch	—	-0.012	—		Reference to 25°C, I _D = -1mA
R _{DS(ON)}	Static Drain-to-Source On-Resistance	N-Ch	—	0.085	0.14	Ω	V _{GS} = 4.5V, I _D = 1.7A ③
			—	0.120	0.20		V _{GS} = 2.7V, I _D = 0.85A ③
		P-Ch	—	0.17	0.27		V _{GS} = -4.5V, I _D = -1.2A ③
			—	0.28	0.40		V _{GS} = -2.7V, I _D = -0.6A ③
V _{GS(th)}	Gate Threshold Voltage	N-Ch	0.7	—	—	V	V _{DS} = V _{GS} , I _D = 250μA
		P-Ch	-0.7	—	—		V _{DS} = V _{GS} , I _D = -250μA
g _{fs}	Forward Transconductance	N-Ch	2.6	—	—	S	V _{DS} = 10V, I _D = 0.85A ③
		P-Ch	1.3	—	—		V _{DS} = -10V, I _D = -0.6A ③
I _{DSS}	Drain-to-Source Leakage Current	N-Ch	—	—	1.0	μA	V _{DS} = 16V, V _{GS} = 0V
		P-Ch	—	—	-1.0		V _{DS} = -16V, V _{GS} = 0V
		N-Ch	—	—	25		V _{DS} = 16V, V _{GS} = 0V, T _J = 125°C
		P-Ch	—	—	-25		V _{DS} = -16V, V _{GS} = 0V, T _J = 125°C
I _{GSS}	Gate-to-Source Forward Leakage	N-P	—	—	±100	V _{GS} = ± 12V	
Q _g	Total Gate Charge	N-Ch	—	5.3	8.0	nC	N-Channel I _D = 1.7A, V _{DS} = 16V, V _{GS} = 4.5V ④
		P-Ch	—	5.4	8.2		
Q _{gs}	Gate-to-Source Charge	N-Ch	—	0.84	1.3	nC	P-Channel I _D = -1.2A, V _{DS} = -16V, V _{GS} = -4.5V
		P-Ch	—	0.96	1.4		
Q _{gd}	Gate-to-Drain ("Miller") Charge	N-Ch	—	2.2	3.3	nC	P-Channel I _D = -1.2A, V _{DS} = -16V, V _{GS} = -4.5V
		P-Ch	—	2.4	3.6		
t _{d(on)}	Turn-On Delay Time	N-Ch	—	5.7	—	ns	N-Channel V _{DD} = 10V, I _D = 1.7A, R _G = 6.0Ω, R _D = 5.7Ω ④
P-Ch	—	9.1	—				
t _r	Rise Time	N-Ch	—	24	—	ns	P-Channel V _{DD} = -10V, I _D = -1.2A, R _G = 6.0Ω, R _D = 8.3Ω ④
		P-Ch	—	35	—		
t _{d(off)}	Turn-Off Delay Time	N-Ch	—	15	—	ns	P-Channel V _{DD} = -10V, I _D = -1.2A, R _G = 6.0Ω, R _D = 8.3Ω ④
		P-Ch	—	38	—		
t _f	Fall Time	N-Ch	—	16	—	ns	P-Channel V _{DD} = -10V, I _D = -1.2A, R _G = 6.0Ω, R _D = 8.3Ω ④
		P-Ch	—	43	—		
C _{iss}	Input Capacitance	N-Ch	—	260	—	pF	N-Channel V _{GS} = 0V, V _{DS} = 15V, f = 1.0MHz ③
		P-Ch	—	240	—		
C _{oss}	Output Capacitance	N-Ch	—	130	—	pF	P-Channel V _{GS} = 0V, V _{DS} = -15V, f = 1.0MHz ③
		P-Ch	—	130	—		
C _{rss}	Reverse Transfer Capacitance	N-Ch	—	61	—	pF	P-Channel V _{GS} = 0V, V _{DS} = -15V, f = 1.0MHz ③
		P-Ch	—	64	—		

Source-Drain Ratings and Characteristics

Parameter	Parameter		Min.	Typ.	Max.	Units	Conditions
I _S	Continuous Source Current (Body Diode)	N-Ch	—	—	1.25	A	
		P-Ch	—	—	-1.25		
I _{SM}	Pulsed Source Current (Body Diode) ①	N-Ch	—	—	19	A	
		P-Ch	—	—	-14		
V _{SD}	Diode Forward Voltage	N-Ch	—	—	1.2	V	T _J = 25°C, I _S = 1.7A, V _{GS} = 0V ③
		P-Ch	—	—	-1.2		T _J = 25°C, I _S = -1.2A, V _{GS} = 0V ③
t _{rr}	Reverse Recovery Time	N-Ch	—	39	59	ns	N-Channel T _J = 25°C, I _F = 1.7A, di/dt = 100A/μs
		P-Ch	—	52	78		
Q _{rr}	Reverse Recovery Charge	N-Ch	—	37	56	nC	P-Channel T _J = 25°C, I _F = -1.2A, di/dt = -100A/μs ③
		P-Ch	—	63	95		

Notes:

- ① Repetitive rating; pulse width limited by max. junction temperature. (See fig. 21)
- ② N-Channel I_{SD} ≤ 1.7A, di/dt ≤ 66A/μs, V_{DD} ≤ V_{(BR)DSS}, T_J ≤ 150°C
P-Channel I_{SD} ≤ -1.2A, di/dt ≤ 100A/μs, V_{DD} ≤ V_{(BR)DSS}, T_J ≤ 150°C
- ③ Pulse width ≤ 300μs; duty cycle ≤ 2%.
- ④ Surface mounted on FR-4 board, t ≤ 10sec.

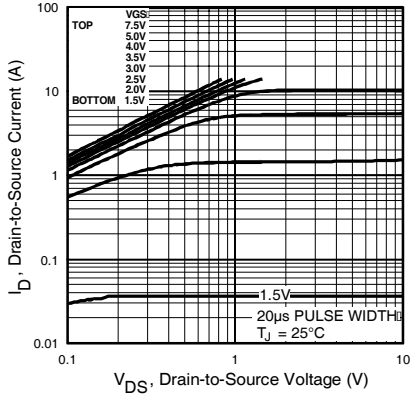

Fig 1. Typical Output Characteristics

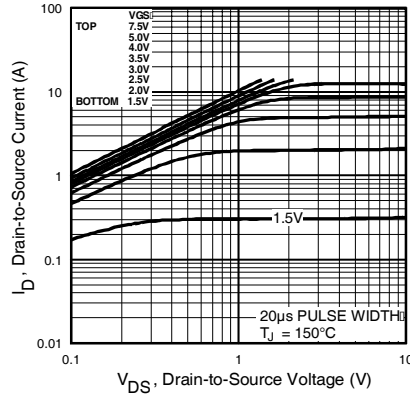

Fig 2. Typical Output Characteristics

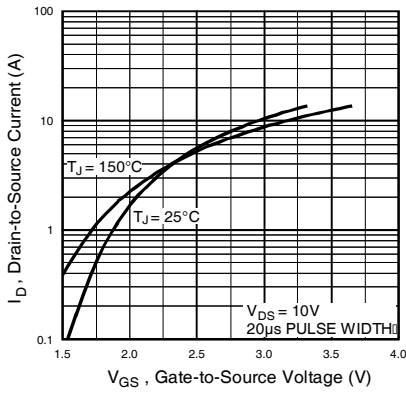

Fig 3. Typical Transfer Characteristics

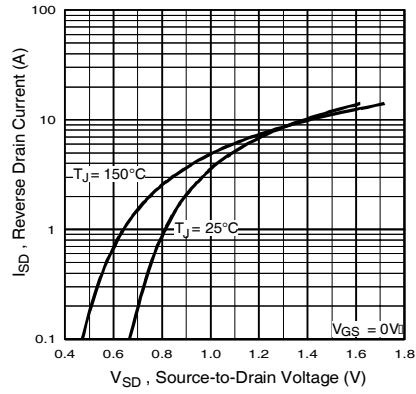

Fig 4. Typical Source-Drain Diode Forward Voltage

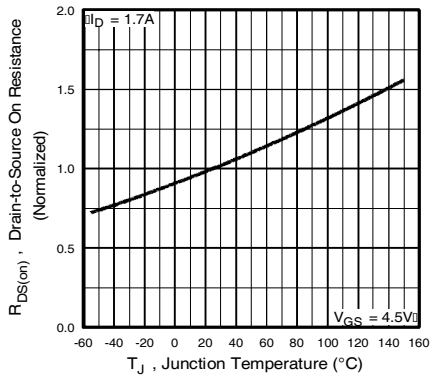

Fig 5. Normalized On-Resistance Vs. Temperature

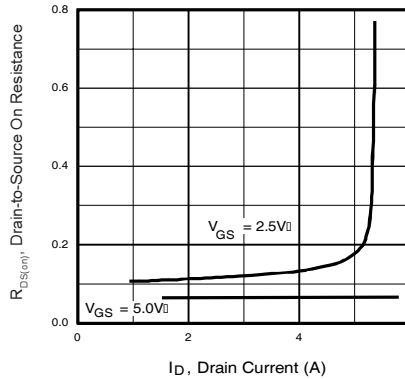

Fig 6. Typical On-Resistance Vs. Drain Current

IRF7507PbF

N - Channel

International
IR Rectifier

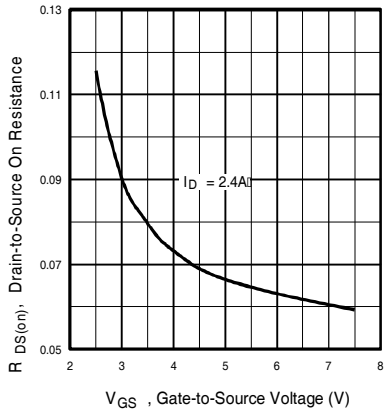

Fig 7. Typical On-Resistance Vs. Gate Voltage

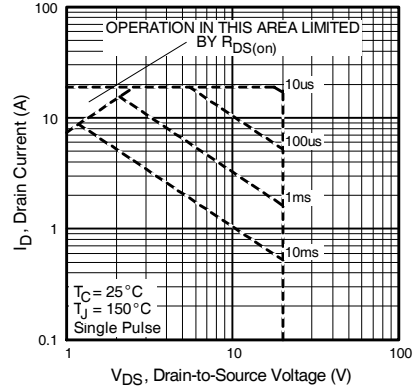

Fig 8. Maximum Safe Operating Area

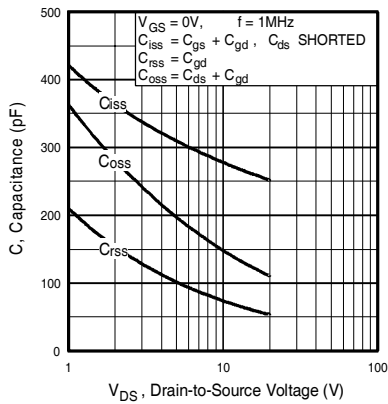

Fig 9. Typical Capacitance Vs. Drain-to-Source Voltage

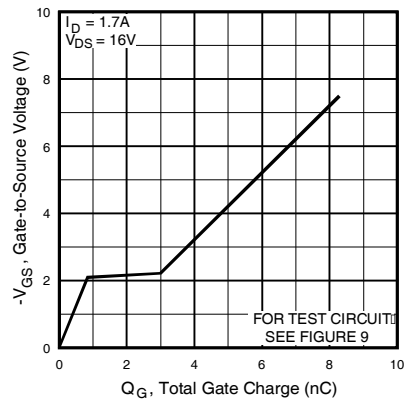

Fig 10. Typical Gate Charge Vs. Gate-to-Source Voltage

P - Channel

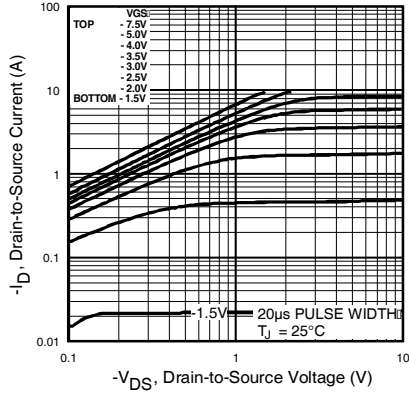

Fig 11. Typical Output Characteristics

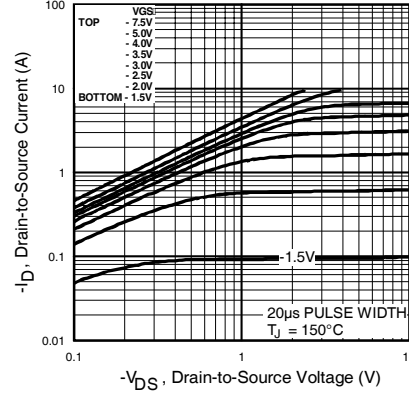

Fig 12. Typical Output Characteristics

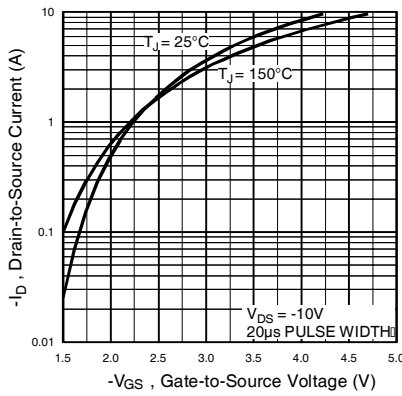

Fig 13. Typical Transfer Characteristics

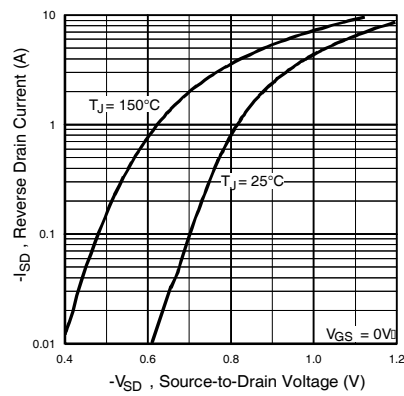

Fig 14. Typical Source-Drain Diode Forward Voltage

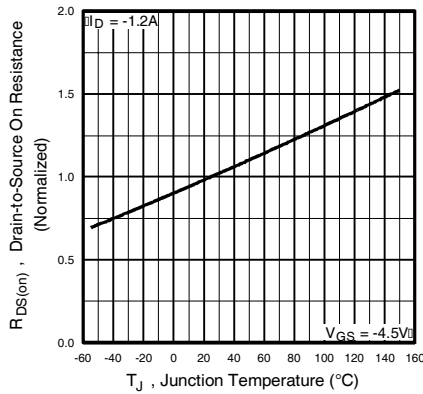

Fig 15. Normalized On-Resistance Vs. Temperature

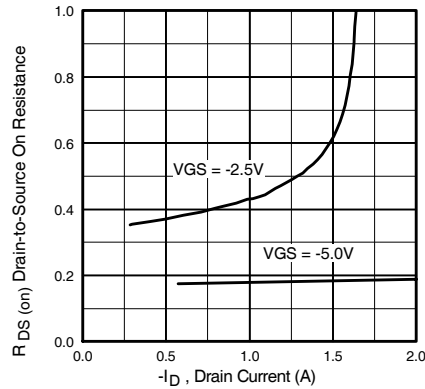

Fig 16. Typical On-Resistance Vs. Drain Current

IRF7507PbF

International
IR Rectifier

P - Channel

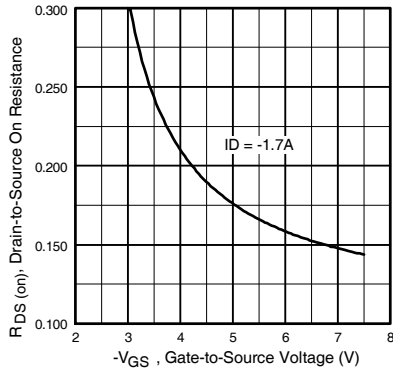

Fig 17. Typical On-Resistance Vs. Gate Voltage

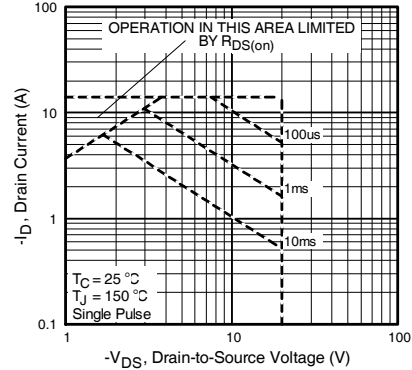

Fig 18. Maximum Safe Operating Area

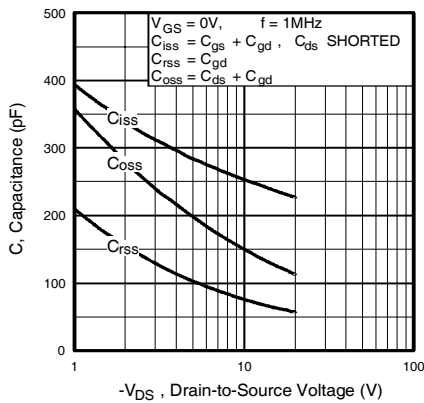

Fig 19. Typical Capacitance Vs. Drain-to-Source Voltage

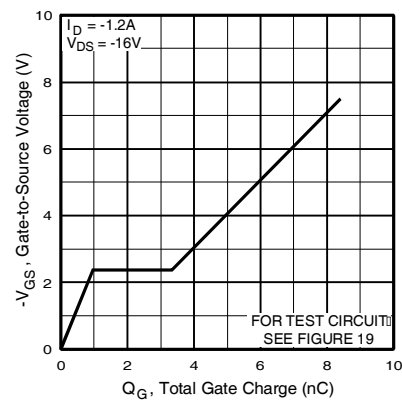

Fig 20. Typical Gate Charge Vs. Gate-to-Source Voltage

N-P - Channel

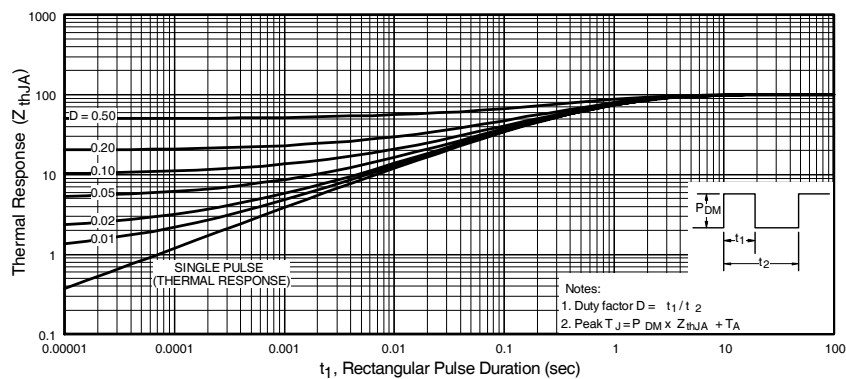
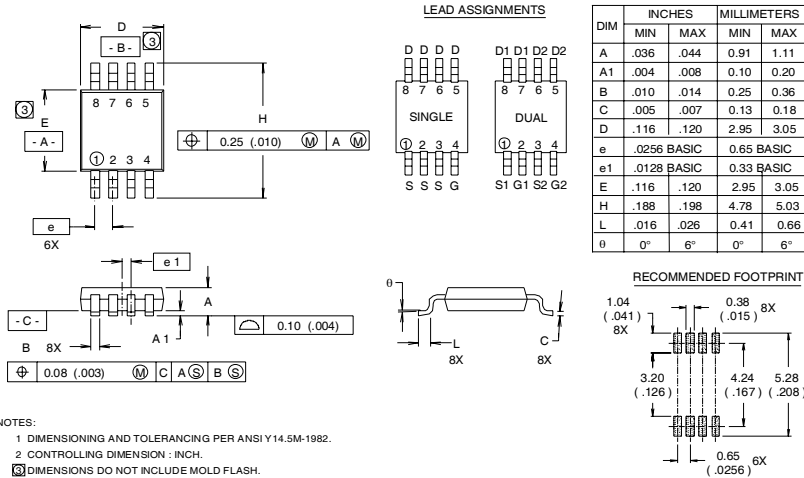

Fig 21. Maximum Effective Transient Thermal Impedance, Junction-to-Ambient

Micro8 Package Outline

Dimensions are shown in millimeters (inches)



Micro8 Part Marking Information

EXAMPLE: THIS IS AN IRF7501

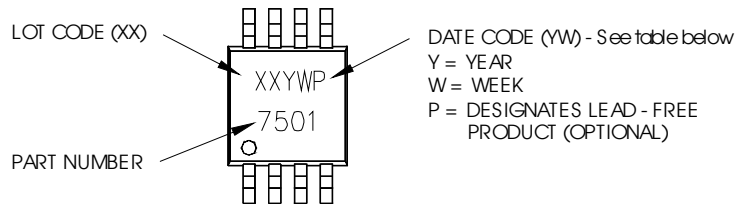

WW = (1-26) IF PRECEDED BY LAST DIGIT OF CALENDAR YEAR

YEAR	Y	WORK WEEK	W
2001	1	01	A
2002	2	02	B
2003	3	03	C
2004	4	04	D
2005	5		
2006	6		
2007	7		
2008	8		
2009	9		
2010	0	24	X
		25	Y
		26	Z

WW = (27-52) IF PRECEDED BY A LETTER

YEAR	Y	WORK WEEK	W
2001	A	27	A
2002	B	28	B
2003	C	29	C
2004	D	30	D
2005	E		
2006	F		
2007	G		
2008	H		
2009	J		
2010	K	50	X
		51	Y
		52	Z

IRF7507PbF

Micro8 Tape & Reel Information

Dimensions are shown in millimeters (inches)

International
IR Rectifier

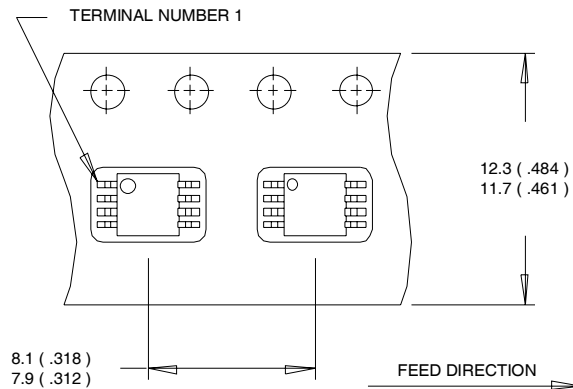

NOTES:

1. OUTLINE CONFORMS TO EIA-481 & EIA-541.
2. CONTROLLING DIMENSION : MILLIMETER.

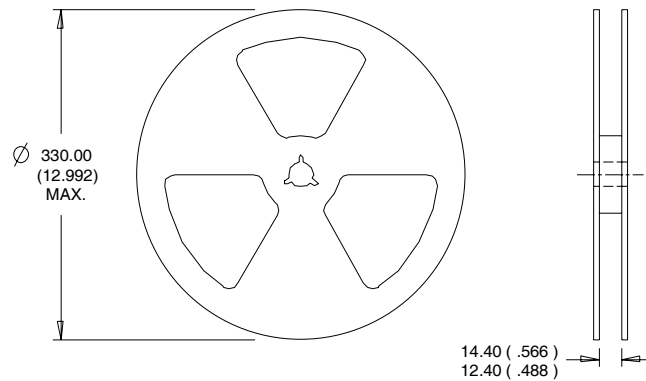

NOTES:

1. CONTROLLING DIMENSION : MILLIMETER.
2. OUTLINE CONFORMS TO EIA-481 & EIA-541.

Data and specifications subject to change without notice.
This product has been designed and qualified for the Consumer market.
Qualification Standards can be found on IR's Web site.

International
IR Rectifier

IR WORLD HEADQUARTERS: 233 Kansas St., El Segundo, California 90245, USA Tel: (310) 252-7105
TAC Fax: (310) 252-7903

Visit us at www.irf.com for sales contact information.05/04