



## Dual N-Channel 30-V (D-S) MOSFET with Schottky Diode

PRODUCT SUMMARY		
$V_{DS}$ (V)	$r_{DS(on)}$ ( $\Omega$ )	$I_D$ (A)
30	0.022 @ $V_{GS} = 10$ V	7.5
	0.030 @ $V_{GS} = 4.5$ V	6.5

SCHOTTKY PRODUCT SUMMARY		
$V_{DS}$ (V)	$V_{SD}$ (V) Diode Forward Voltage	$I_F$ (A)
30	0.50 V @ 1.0 A	2.0

LITTLE FOOT PLUS™

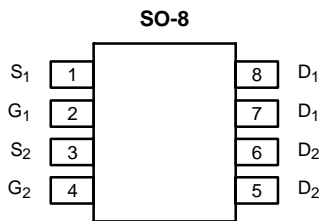

Top View

Ordering Information: Si4808DY  
Si4808DY-T1 (with Tape and Reel)

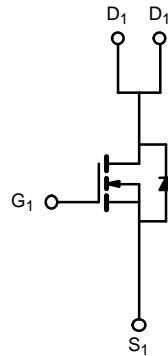

N-Channel MOSFET

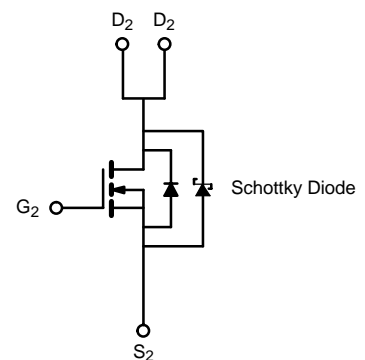

N-Channel MOSFET

ABSOLUTE MAXIMUM RATINGS ( $T_A = 25^\circ\text{C}$ UNLESS OTHERWISE NOTED)					
Parameter	Symbol	10 secs	Steady State	Unit	
Drain-Source Voltage	$V_{DS}$	30		V	
Gate-Source Voltage	$V_{GS}$	$\pm 20$			
Continuous Drain Current ( $T_J = 150^\circ\text{C}$ ) <sup>a</sup>	$I_D$	$T_A = 25^\circ\text{C}$	7.5	5.7	A
		$T_A = 70^\circ\text{C}$	6.0	4.6	
Pulsed Drain Current	$I_{DM}$	30		A	
Continuous Source Current (Diode Conduction) <sup>a</sup>	$I_S$	1.7	0.9		
Maximum Power Dissipation <sup>a</sup>	$P_D$	$T_A = 25^\circ\text{C}$	2.0	1.1	W
		$T_A = 70^\circ\text{C}$	1.3	0.7	
Operating Junction and Storage Temperature Range	$T_J, T_{stg}$	-55 to 150		$^\circ\text{C}$	

THERMAL RESISTANCE RATINGS							
Parameter	Symbol	MOSFET		Schottky		Unit	
		Typ	Max	Typ	Max		
Maximum Junction-to-Ambient <sup>a</sup>	$R_{thJA}$	$t \leq 10$ sec	52	62.5	53	62.5	$^\circ\text{C/W}$
		Steady-State	93	110	93	110	
Maximum Junction-to-Foot (Drain)	$R_{thJC}$	35	40	35	40		

Notes

a. Surface Mounted on 1" x 1" FR4 Board.

<b>MOSFET SPECIFICATIONS (T<sub>J</sub> = 25 °C UNLESS OTHERWISE NOTED).</b>						
Parameter	Symbol	Test Condition	Min	Typ <sup>a</sup>	Max	Unit
<b>Static</b>						
Gate Threshold Voltage	V <sub>GS(th)</sub>	V <sub>DS</sub> = V <sub>GS</sub> , I <sub>D</sub> = 250 μA	0.8			V
Gate-Body Leakage	I <sub>GSS</sub>	V <sub>DS</sub> = 0 V, V <sub>GS</sub> = ±20 V			±100	nA
Zero Gate Voltage Drain Current	I <sub>DSS</sub>	V <sub>DS</sub> = 24 V, V <sub>GS</sub> = 0 V	Ch-1		1	μA
			Ch-2		100	
		V <sub>DS</sub> = 24 V, V <sub>GS</sub> = 0 V, T <sub>J</sub> = 85 °C	Ch-1		15	
			Ch-2		2000	
On-State Drain Current <sup>b</sup>	I <sub>D(on)</sub>	V <sub>DS</sub> = 5 V, V <sub>GS</sub> = 10 V	20			A
Drain-Source On-State Resistance <sup>b</sup>	r <sub>DS(on)</sub>	V <sub>GS</sub> = 10 V, I <sub>D</sub> = 7.5 A		0.018	0.022	Ω
		V <sub>GS</sub> = 4.5 V, I <sub>D</sub> = 6.5 A		0.024	0.030	
Forward Transconductance <sup>b</sup>	g <sub>fs</sub>	V <sub>DS</sub> = 15 V, I <sub>D</sub> = 7.5 A		22		S
Diode Forward Voltage <sup>b</sup>	V <sub>SD</sub>	I <sub>S</sub> = 1 A, V <sub>GS</sub> = 0 V	Ch-1	0.8	1.2	V
			Ch-2	0.47	0.5	
<b>Dynamic<sup>a</sup></b>						
Total Gate Charge	Q <sub>g</sub>	V <sub>DS</sub> = 15 V, V <sub>GS</sub> = 10 V, I <sub>D</sub> = 7.5 A		13	20	nC
Gate-Source Charge	Q <sub>gs</sub>			2		
Gate-Drain Charge	Q <sub>gd</sub>			2.7		
Gate Resistance	R <sub>g</sub>		0.5		3.2	Ω
Turn-On Delay Time	t <sub>d(on)</sub>	V <sub>DD</sub> = 15 V, R <sub>L</sub> = 15 Ω I <sub>D</sub> ≅ 1 A, V <sub>GEN</sub> = 10 V, R <sub>G</sub> = 6 Ω		8	16	ns
Rise Time	t <sub>r</sub>			10	20	
Turn-Off Delay Time	t <sub>d(off)</sub>			21	40	
Fall Time	t <sub>f</sub>			10	20	
Source-Drain Reverse Recovery Time	t <sub>rr</sub>	I <sub>F</sub> = 1.7 A, di/dt = 100 A/μs	Ch-1	40	80	
			Ch-2	32	70	

## Notes

- a. Guaranteed by design, not subject to production testing.  
b. Pulse test; pulse width ≤ 300 μs, duty cycle ≤ 2%.

<b>SCHOTTKY SPECIFICATIONS (T<sub>J</sub> = 25 °C UNLESS OTHERWISE NOTED)</b>						
Parameter	Symbol	Test Condition	Min	Typ	Max	Unit
Forward Voltage Drop	V <sub>F</sub>	I <sub>F</sub> = 1.0 A		0.47	0.50	V
		I <sub>F</sub> = 1.0 A, T <sub>J</sub> = 125 °C		0.36	0.42	
Maximum Reverse Leakage Current	I <sub>rm</sub>	V <sub>r</sub> = 30 V		0.004	0.100	mA
		V <sub>r</sub> = 30 V, T <sub>J</sub> = 100 °C		0.7	10	
		V <sub>r</sub> = -30 V, T <sub>J</sub> = 125 °C		3.0	20	
Junction Capacitance	C <sub>T</sub>	V <sub>r</sub> = 10 V		50		pF



**TYPICAL CHARACTERISTICS (25°C UNLESS NOTED) MOSFET**

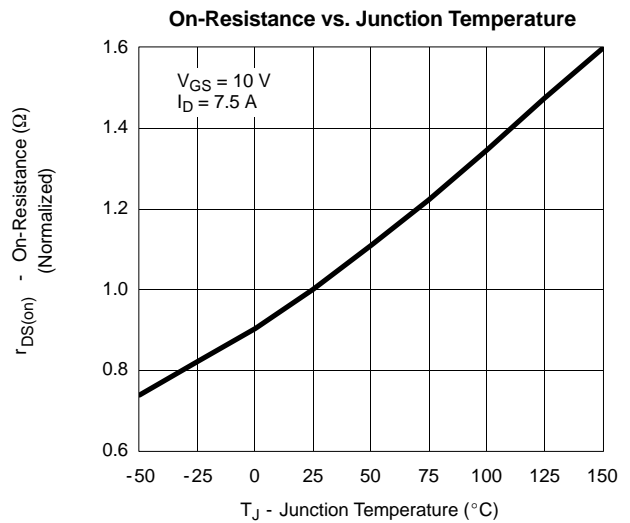
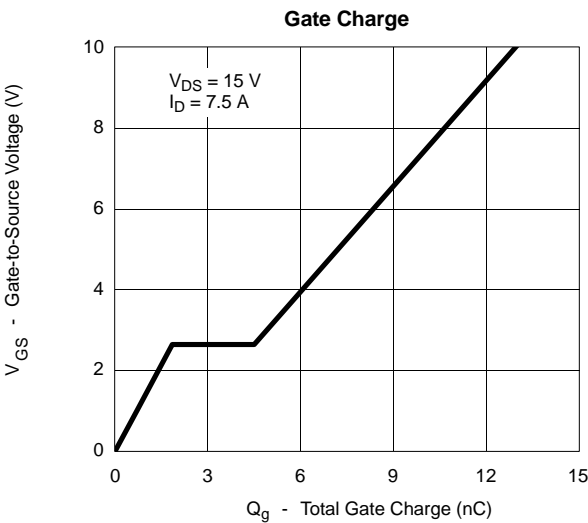
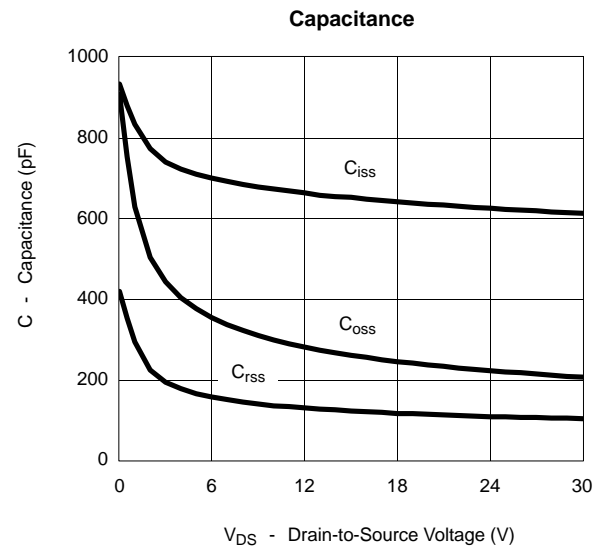
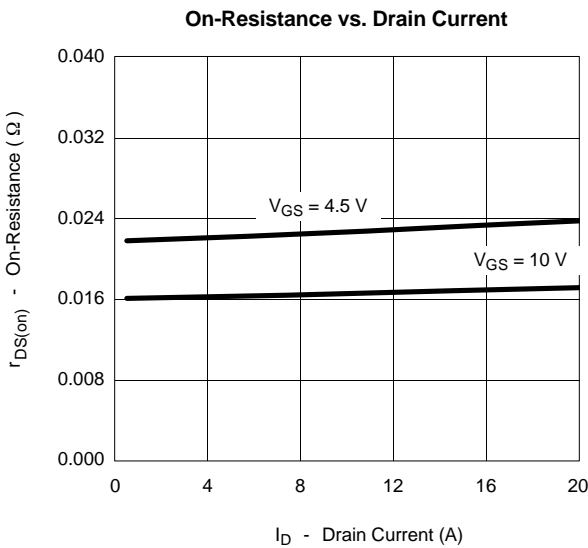
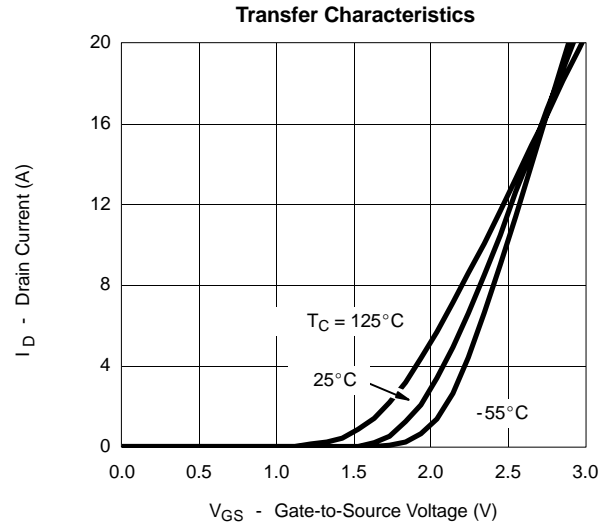
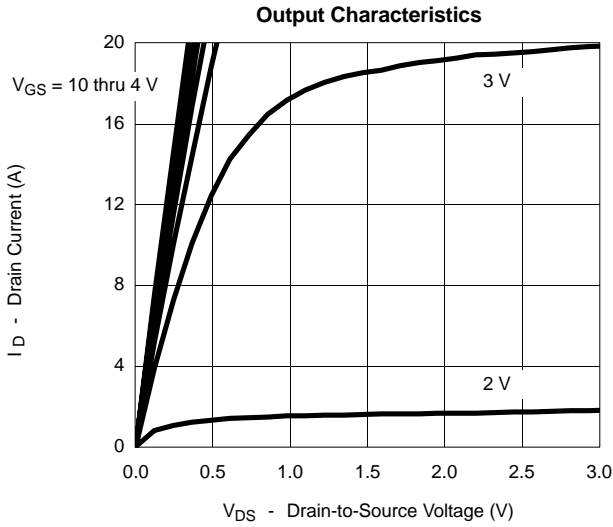

**TYPICAL CHARACTERISTICS (25 °C UNLESS NOTED)**

**MOSFET**

**Source-Drain Diode Forward Voltage**

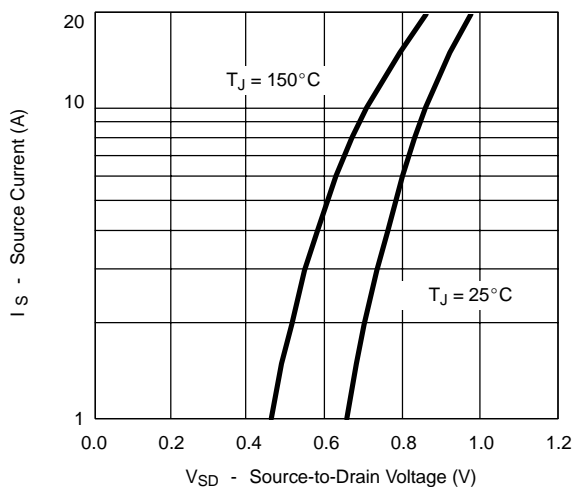

**On-Resistance vs. Gate-to-Source Voltage**

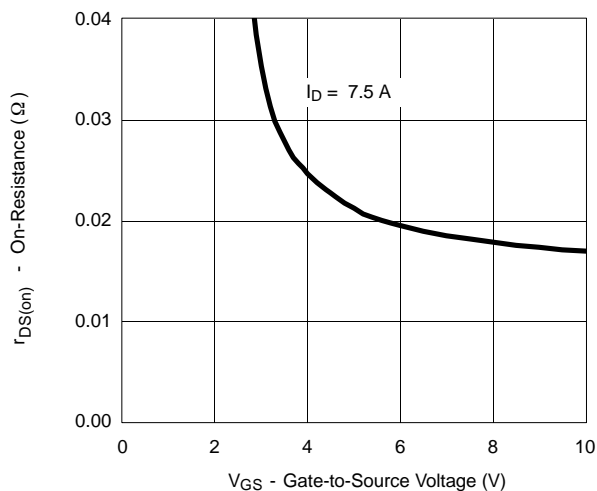

**Threshold Voltage**

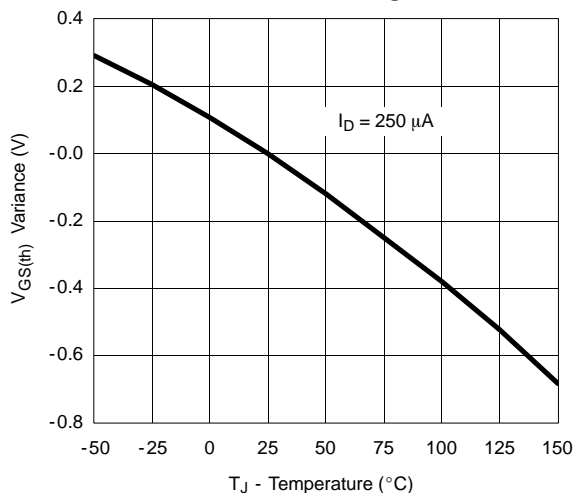

**Single Pulse Power**

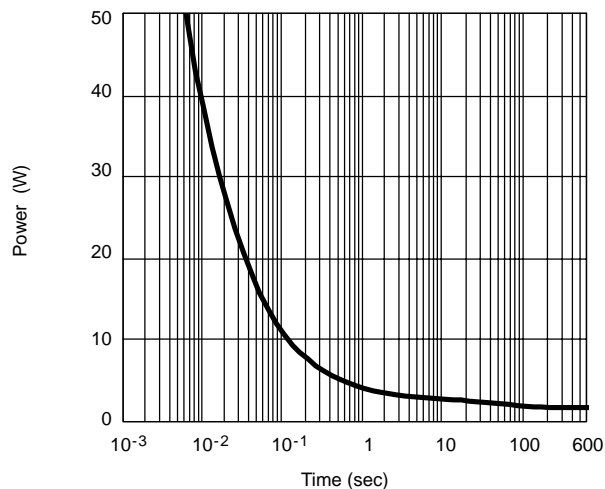

**Normalized Thermal Transient Impedance, Junction-to-Ambient**

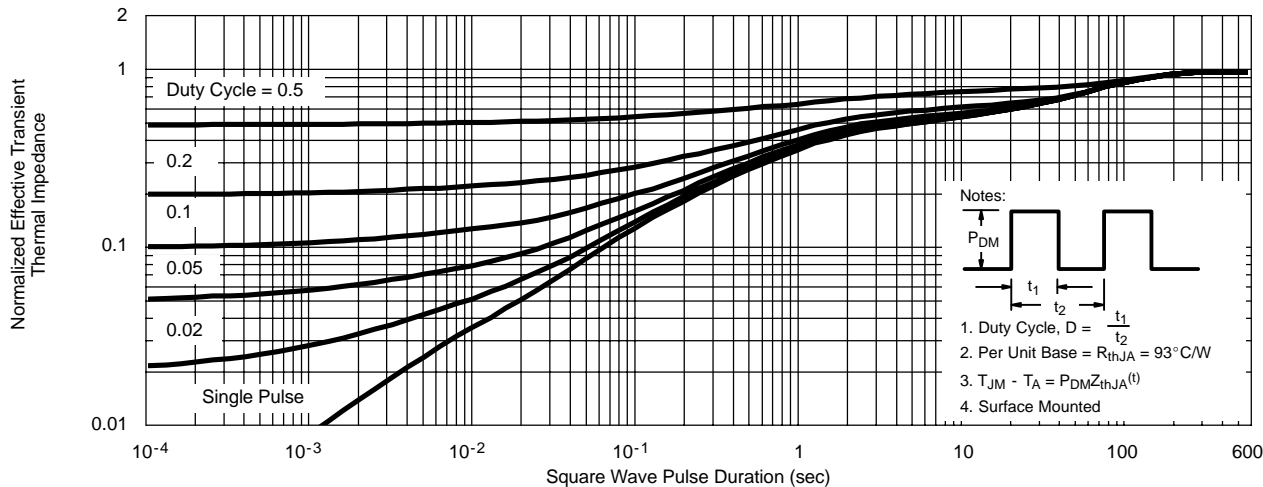



**TYPICAL CHARACTERISTICS (25 °C UNLESS NOTED)**

**MOSFET**

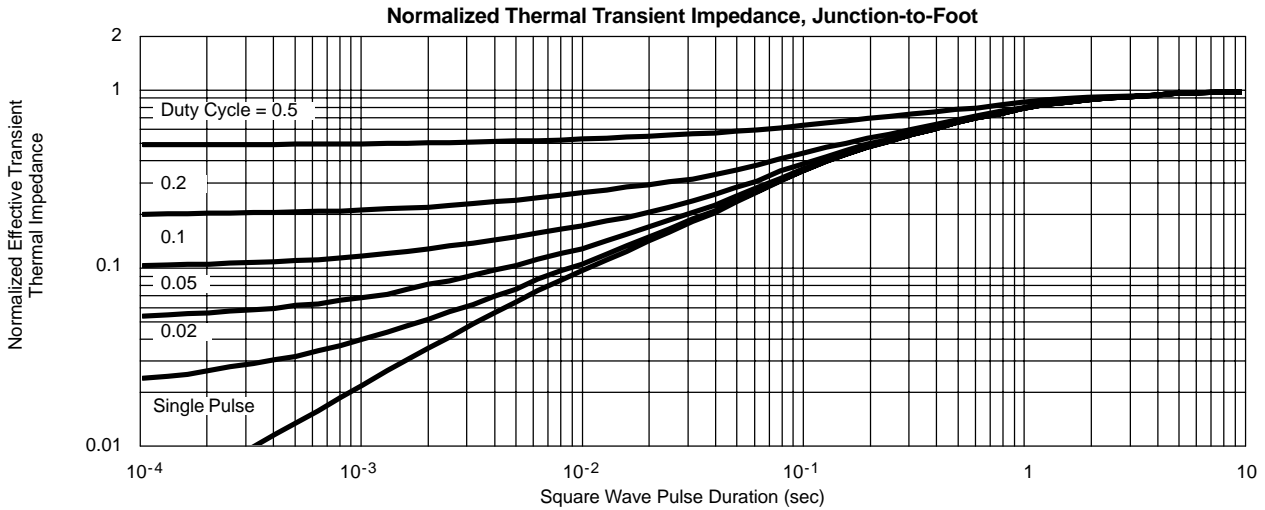

**TYPICAL CHARACTERISTICS (25 °C UNLESS NOTED)**

**SCHOTTKY**

