



## Dual N-Channel 30-V (D-S) MOSFET with Schottky Diode

PRODUCT SUMMARY			
	V <sub>DS</sub> (V)	r <sub>DS(on)</sub> (Ω)	I <sub>D</sub> (A)
Channel-1	30	0.022 @ V <sub>GS</sub> = 10 V	6.3
		0.030 @ V <sub>GS</sub> = 4.5 V	5.4
Channel-2		0.0155 @ V <sub>GS</sub> = 10 V	9.5
		0.0205 @ V <sub>GS</sub> = 4.5 V	8.2

**LITTLE FOOT PLUS™**

SCHOTTKY PRODUCT SUMMARY		
V <sub>DS</sub> (V)	V <sub>SD</sub> (V) Diode Forward Voltage	I <sub>F</sub> (A)
30	0.50 V @ 1.0 A	2.0

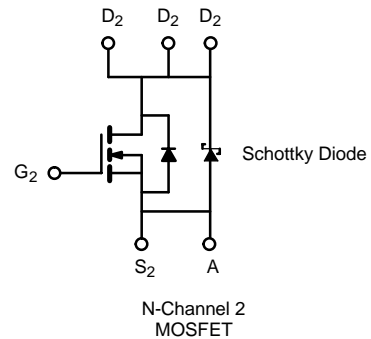
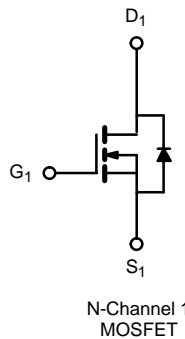
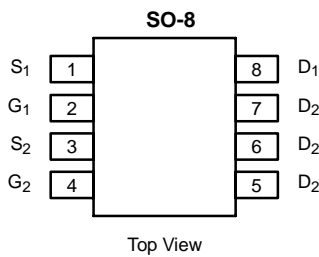

Ordering Information: Si4818DY  
Si4818DY-T1 (with Tape and Reel)

ABSOLUTE MAXIMUM RATINGS (T <sub>A</sub> = 25°C UNLESS OTHERWISE NOTED)							
Parameter	Symbol	Channel-1		Channel-2		Unit	
		10 secs	Steady State	10 secs	Steady State		
Drain-Source Voltage	V <sub>DS</sub>	30				V	
Gate-Source Voltage	V <sub>GS</sub>	20					
Continuous Drain Current (T <sub>J</sub> = 150°C) <sup>a</sup>	I <sub>D</sub>	T <sub>A</sub> = 25°C	6.3	5.3	9.5	7.0	A
		T <sub>A</sub> = 70°C	5.4	4.2	7.6	5.6	
Pulsed Drain Current	I <sub>DM</sub>	30		40		W	
Continuous Source Current (Diode Conduction) <sup>a</sup>	I <sub>S</sub>	1.3	0.9	2.2	1.15		
Maximum Power Dissipation <sup>a</sup>	P <sub>D</sub>	T <sub>A</sub> = 25°C	1.4	1.0	2.4	1.25	W
		T <sub>A</sub> = 70°C	0.9	0.64	1.5	0.80	
Operating Junction and Storage Temperature Range	T <sub>J</sub> , T <sub>stg</sub>	-55 to 150				°C	

THERMAL RESISTANCE RATINGS									
Parameter	Symbol	Channel-1		Channel-2		Schottky		Unit	
		Typ	Max	Typ	Max	Typ	Max		
Maximum Junction-to-Ambient <sup>a</sup>	R <sub>thJA</sub>	t ≤ 10 sec	72	90	43	53	48	60	°C/W
		Steady-State	100	125	82	100	80	100	
Maximum Junction-to-Foot (Drain)	R <sub>thJC</sub>	51	63	25	30	28	35		

Notes  
a. Surface Mounted on 1" x 1" FR4 Board.

<b>MOSFET SPECIFICATIONS (T<sub>J</sub> = 25°C UNLESS OTHERWISE NOTED).</b>							
Parameter	Symbol	Test Condition	Min	Typ <sup>a</sup>	Max	Unit	
<b>Static</b>							
Gate Threshold Voltage	V <sub>GS(th)</sub>	V <sub>DS</sub> = V <sub>GS</sub> , I <sub>D</sub> = 250 μA	Ch-1	0.8		V	
			Ch-2	1.0			
Gate-Body Leakage	I <sub>GSS</sub>	V <sub>DS</sub> = 0 V, V <sub>GS</sub> = 20 V	Ch-1		100	nA	
			Ch-2		100		
Zero Gate Voltage Drain Current	I <sub>DSS</sub>	V <sub>DS</sub> = 24 V, V <sub>GS</sub> = 0 V	Ch-1		1	μA	
			Ch-2		100		
		V <sub>DS</sub> = 24 V, V <sub>GS</sub> = 0 V, T <sub>J</sub> = 85°C	Ch-1		15		
			Ch-2		2000		
On-State Drain Current <sup>b</sup>	I <sub>D(on)</sub>	V <sub>DS</sub> = 5 V, V <sub>GS</sub> = 10 V	Ch-1	20		A	
			Ch-2	30			
Drain-Source On-State Resistance <sup>b</sup>	r <sub>DS(on)</sub>	V <sub>GS</sub> = 10 V, I <sub>D</sub> = 6.3 A	Ch-1		0.018	0.022	Ω
		V <sub>GS</sub> = 10 V, I <sub>D</sub> = 9.5 A	Ch-2		0.0125	0.0155	
		V <sub>GS</sub> = 4.5 V, I <sub>D</sub> = 5.4 A	Ch-1		0.024	0.030	
		V <sub>GS</sub> = 4.5 V, I <sub>D</sub> = 8.2 A	Ch-2		0.0165	0.0205	
Forward Transconductance <sup>b</sup>	g <sub>fs</sub>	V <sub>DS</sub> = 15 V, I <sub>D</sub> = 6.3 A	Ch-1		17	S	
		V <sub>DS</sub> = 15 V, I <sub>D</sub> = 9.5 A	Ch-2		28		
Diode Forward Voltage <sup>b</sup>	V <sub>SD</sub>	I <sub>S</sub> = 1.3 A, V <sub>GS</sub> = 0 V	Ch-1		0.7	1.1	V
		I <sub>S</sub> = 1 A, V <sub>GS</sub> = 0 V	Ch-2		0.47	0.5	
<b>Dynamic<sup>a</sup></b>							
Total Gate Charge	Q <sub>g</sub>	Channel-1 V <sub>DS</sub> = 15 V, V <sub>GS</sub> = 5 V, I <sub>D</sub> = 6.3 A	Ch-1		8.0	12	nC
			Ch-2		15	23	
Gate-Source Charge	Q <sub>GS</sub>	Channel-2 V <sub>DS</sub> = 15 V, V <sub>GS</sub> = 5 V, I <sub>D</sub> = -9.5 A	Ch-1		1.75		
			Ch-2		5.3		
Gate-Drain Charge	Q <sub>gd</sub>		Ch-1		3.2		
			Ch-2		4.6		
Gate Resistance	R <sub>g</sub>		Ch-1	1.5		6.1	Ω
			Ch-2	0.5		2.6	
Turn-On Delay Time	t <sub>d(on)</sub>	Channel-1 V <sub>DD</sub> = 15 V, R <sub>L</sub> = 15 Ω I <sub>D</sub> ≅ 1 A, V <sub>GEN</sub> = 10 V, R <sub>G</sub> = 6 Ω	Ch-1		10	20	ns
			Ch-2		15	30	
Rise Time	t <sub>r</sub>	Channel-2 V <sub>DD</sub> = 15 V, R <sub>L</sub> = 15 Ω I <sub>D</sub> ≅ 1 A, V <sub>GEN</sub> = 10 V, R <sub>G</sub> = 6 Ω	Ch-1		5	10	
			Ch-2		5	10	
Turn-Off Delay Time	t <sub>d(off)</sub>		Ch-1		26	50	
			Ch-2		44	80	
Fall Time	t <sub>f</sub>		Ch-1		8	16	
			Ch-2		12	24	
Source-Drain Reverse Recovery Time	t <sub>rr</sub>	I <sub>F</sub> = 1.3 A, di/dt = 100 A/μs	Ch-1		30	60	
		I <sub>F</sub> = 2.2 A, di/dt = 100 A/μs	Ch-2		32	70	

## Notes

- a. Guaranteed by design, not subject to production testing.  
b. Pulse test; pulse width ≤ 300 μs, duty cycle ≤ 2%.

<b>SCHOTTKY SPECIFICATIONS (T<sub>J</sub> = 25°C UNLESS OTHERWISE NOTED)</b>						
Parameter	Symbol	Test Condition	Min	Typ	Max	Unit
Forward Voltage Drop	V <sub>F</sub>	I <sub>F</sub> = 1.0 A		0.47	0.50	V
		I <sub>F</sub> = 1.0 A, T <sub>J</sub> = 125°C		0.36	0.42	
Maximum Reverse Leakage Current	I <sub>rm</sub>	V <sub>r</sub> = 30 V		0.004	0.100	mA
		V <sub>r</sub> = 30 V, T <sub>J</sub> = 100°C		0.7	10	
		V <sub>r</sub> = -30 V, T <sub>J</sub> = 125°C		3.0	20	
Junction Capacitance	C <sub>T</sub>	V <sub>r</sub> = 10 V		50		pF

**TYPICAL CHARACTERISTICS (25°C UNLESS NOTED) CHANNEL-1**

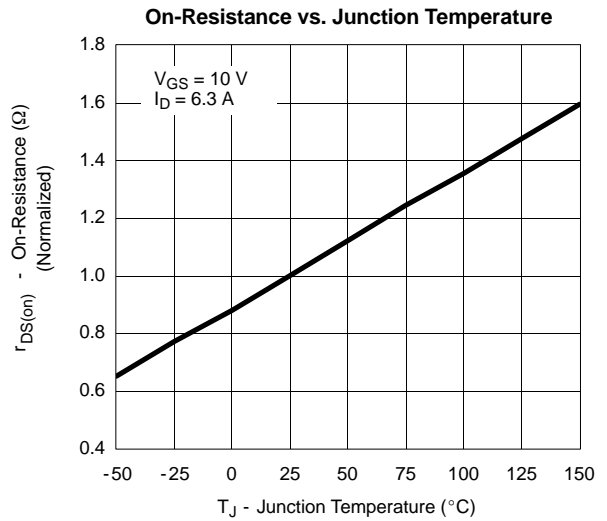
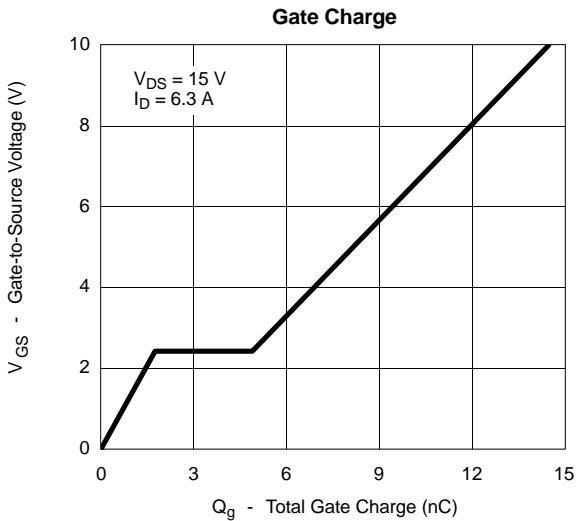
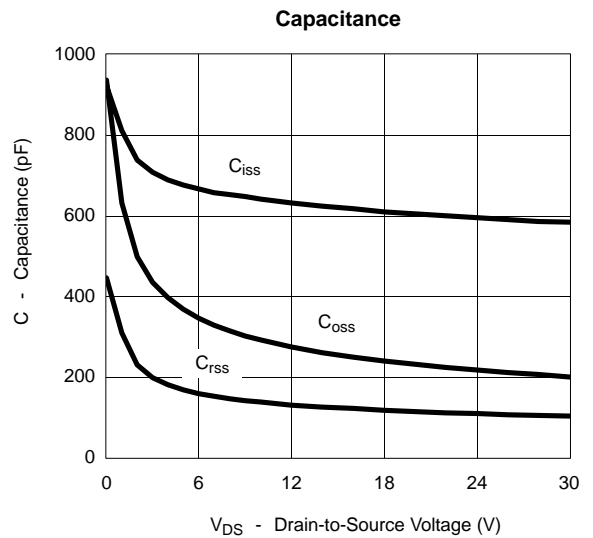
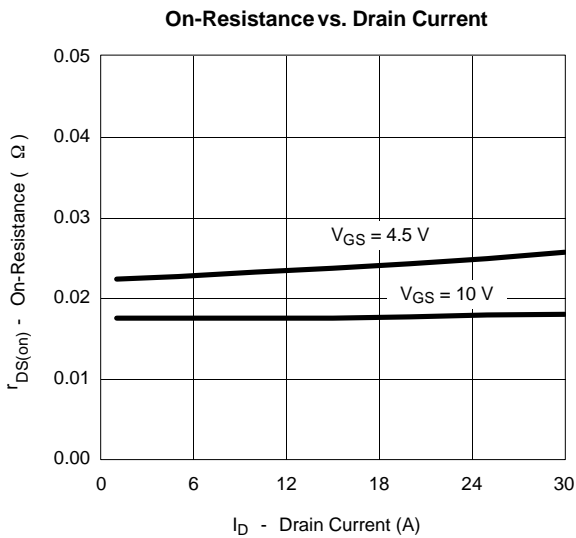
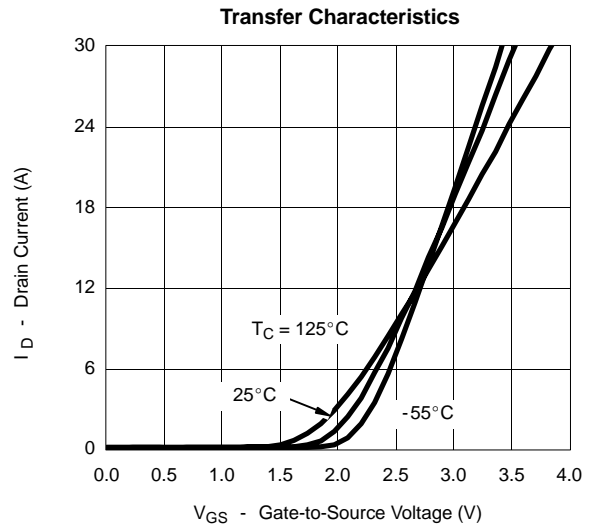
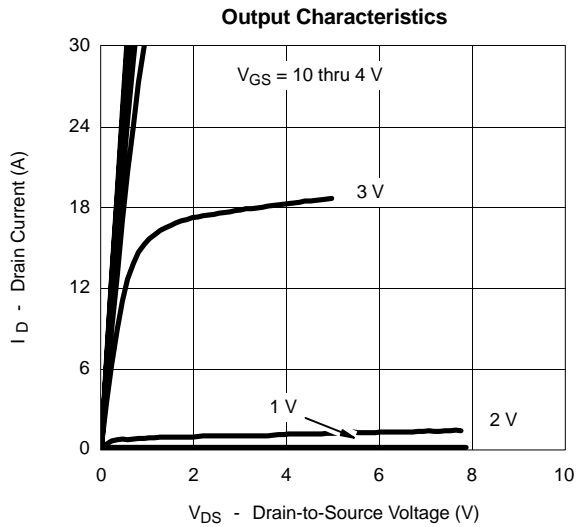

**TYPICAL CHARACTERISTICS (25°C UNLESS NOTED)**

**CHANNEL-1**

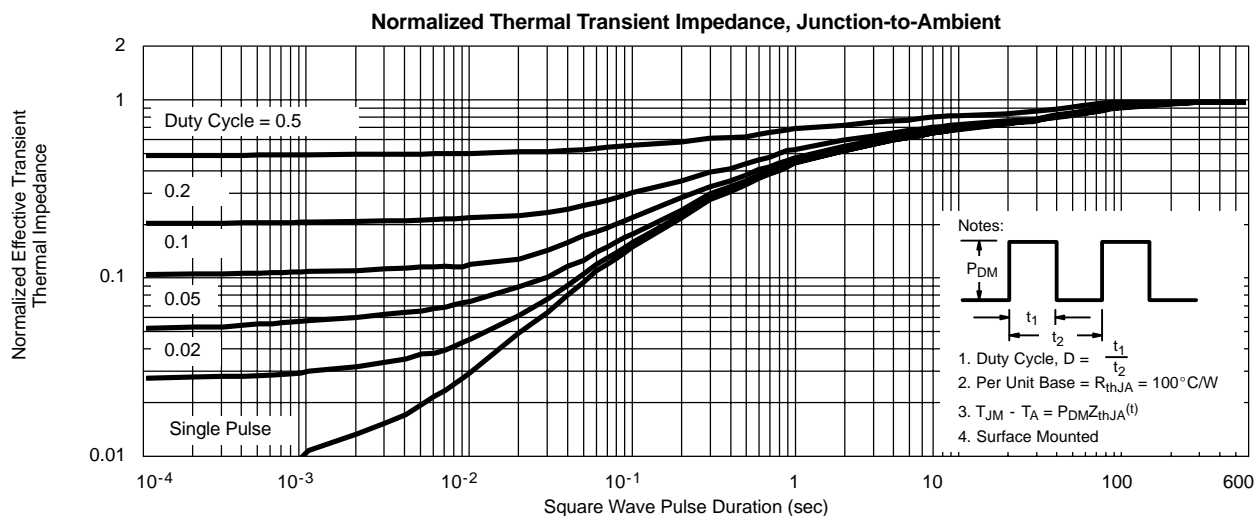
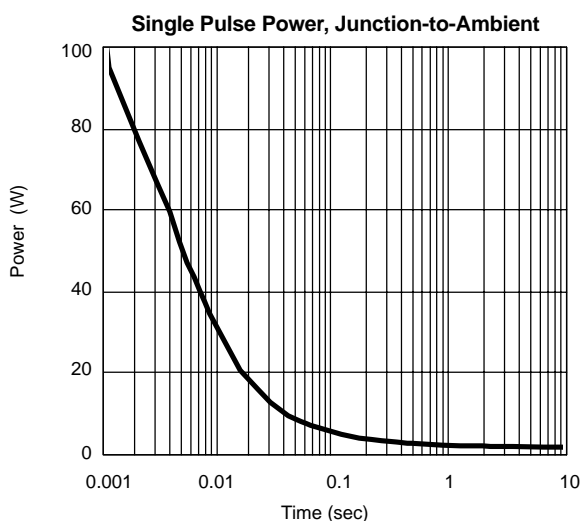
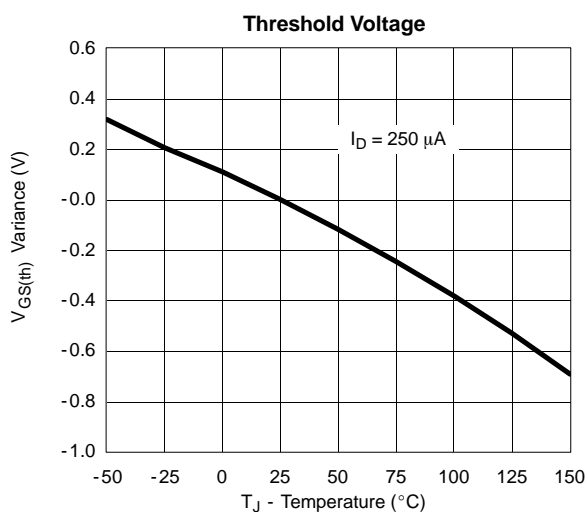
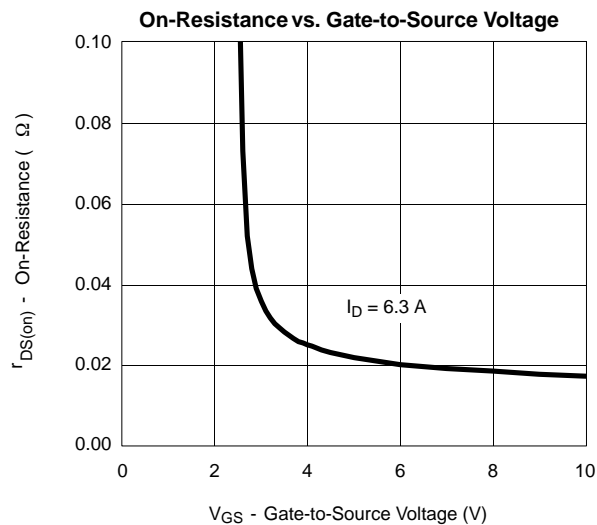
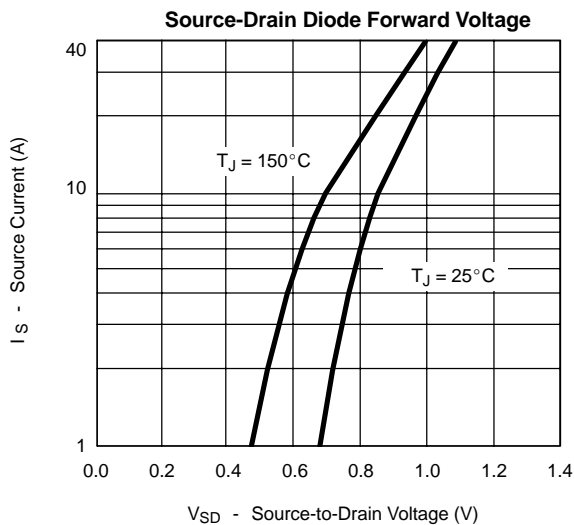



**TYPICAL CHARACTERISTICS (25°C UNLESS NOTED) CHANNEL-1**

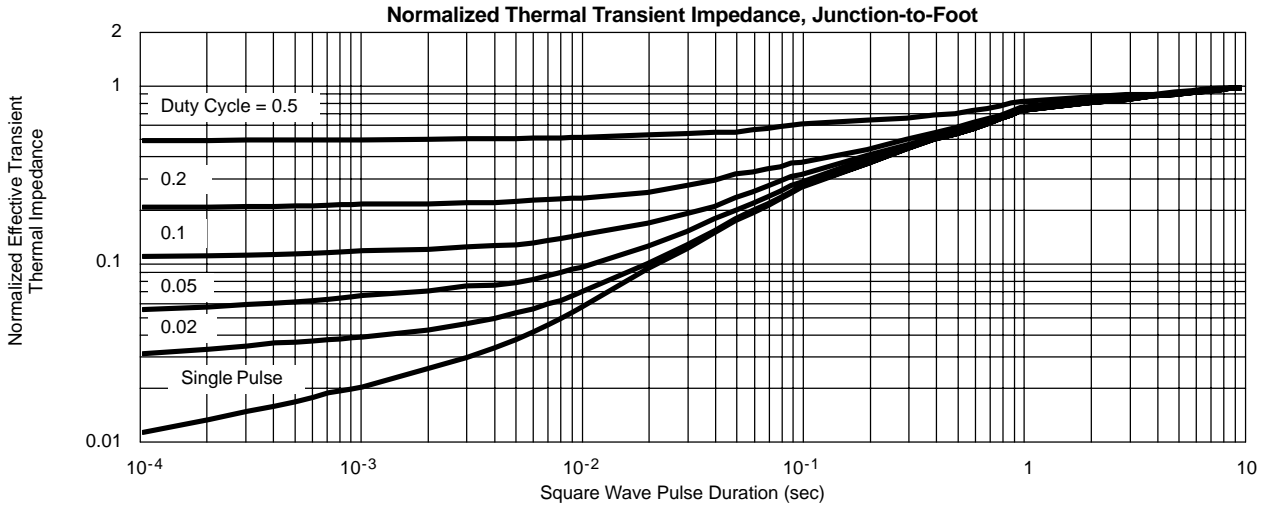

**TYPICAL CHARACTERISTICS (25°C UNLESS NOTED) CHANNEL-2**

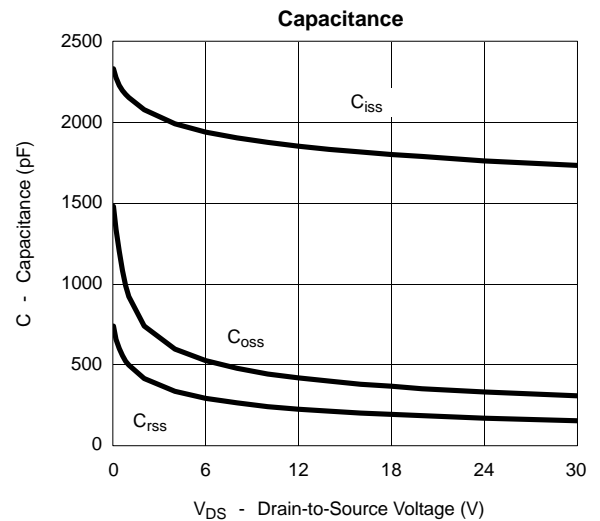
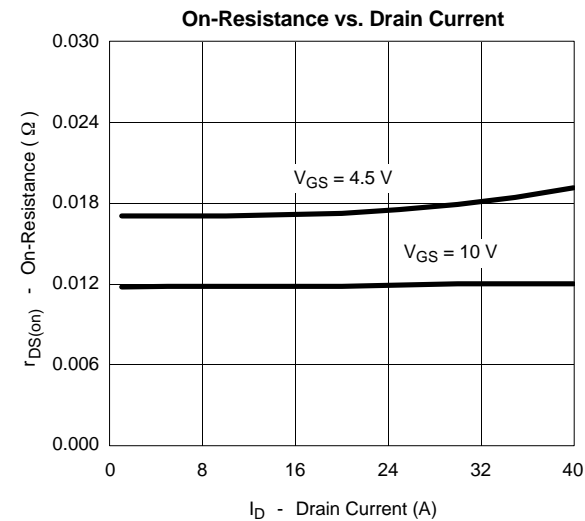
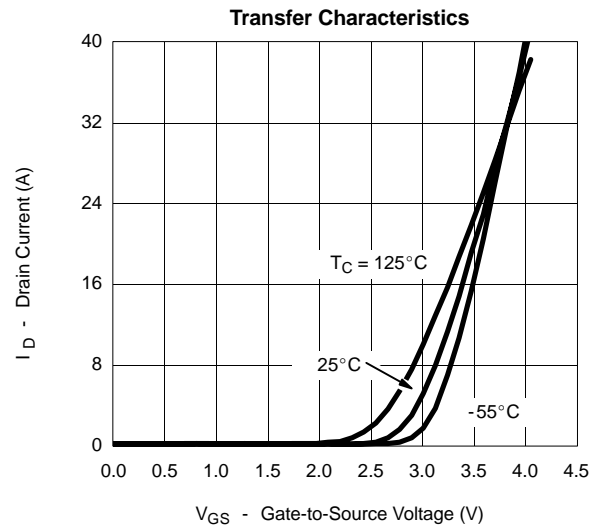
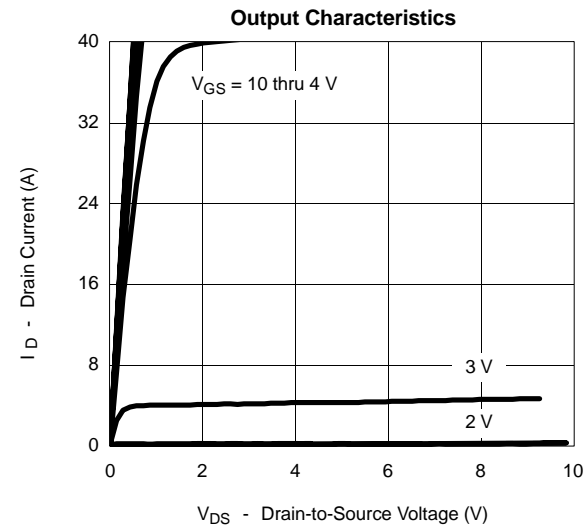

**TYPICAL CHARACTERISTICS (25 °C UNLESS NOTED)**

**CHANNEL-2**

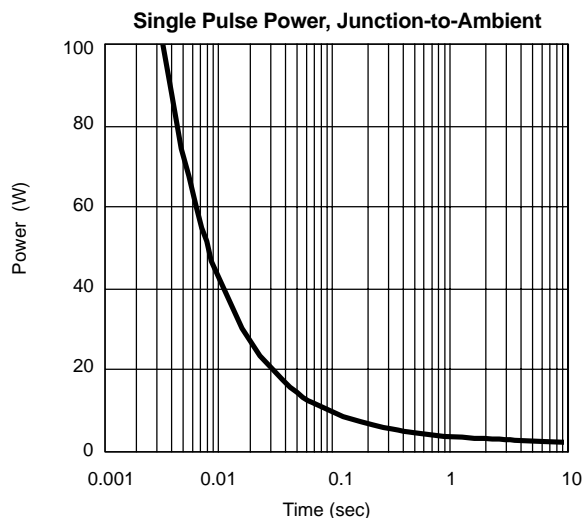
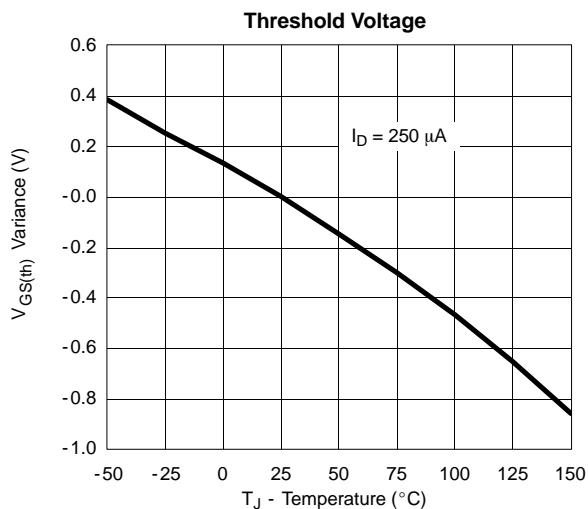
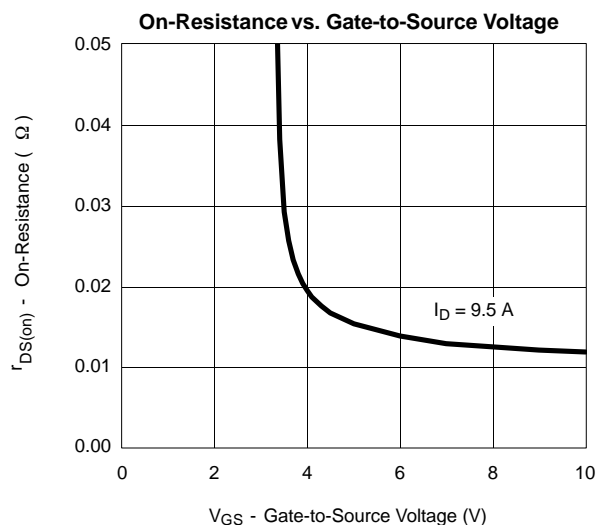
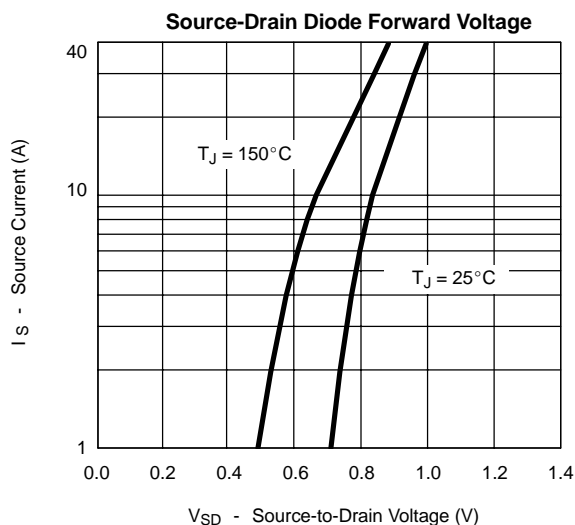
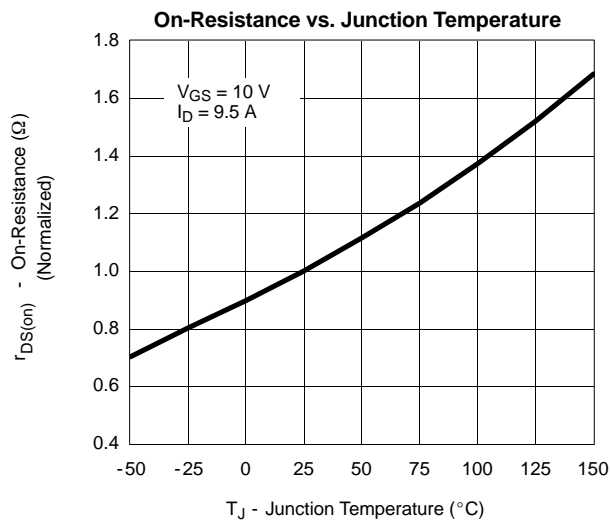
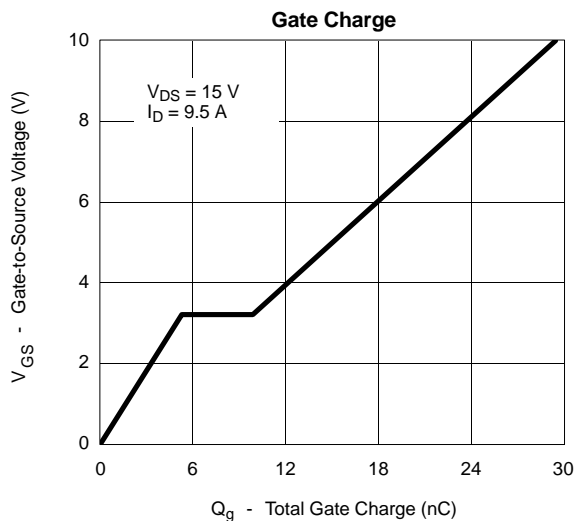

**TYPICAL CHARACTERISTICS (25°C UNLESS NOTED) CHANNEL-2**

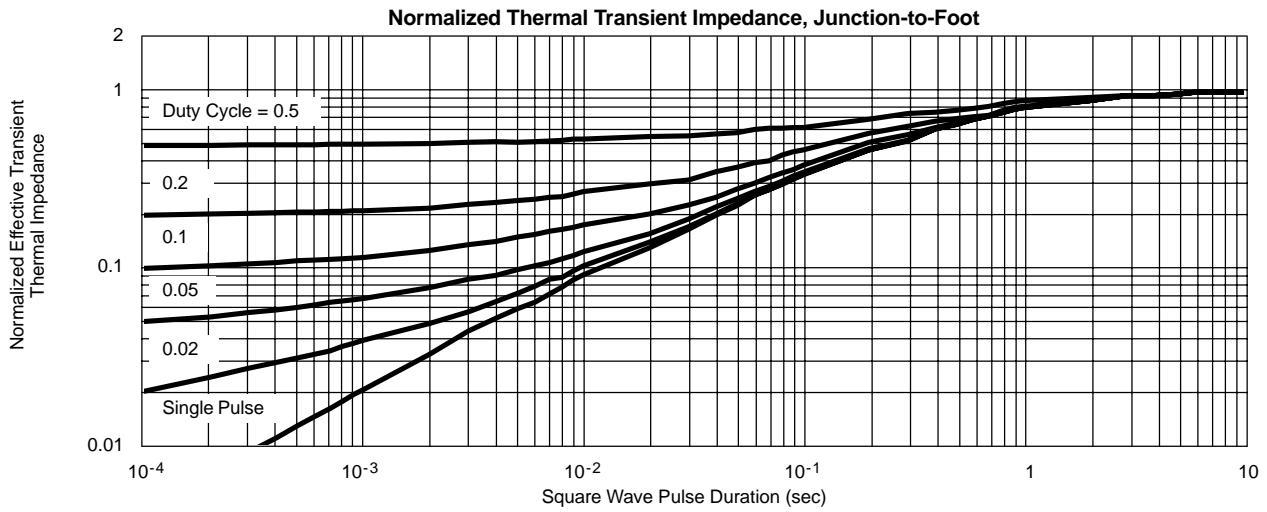
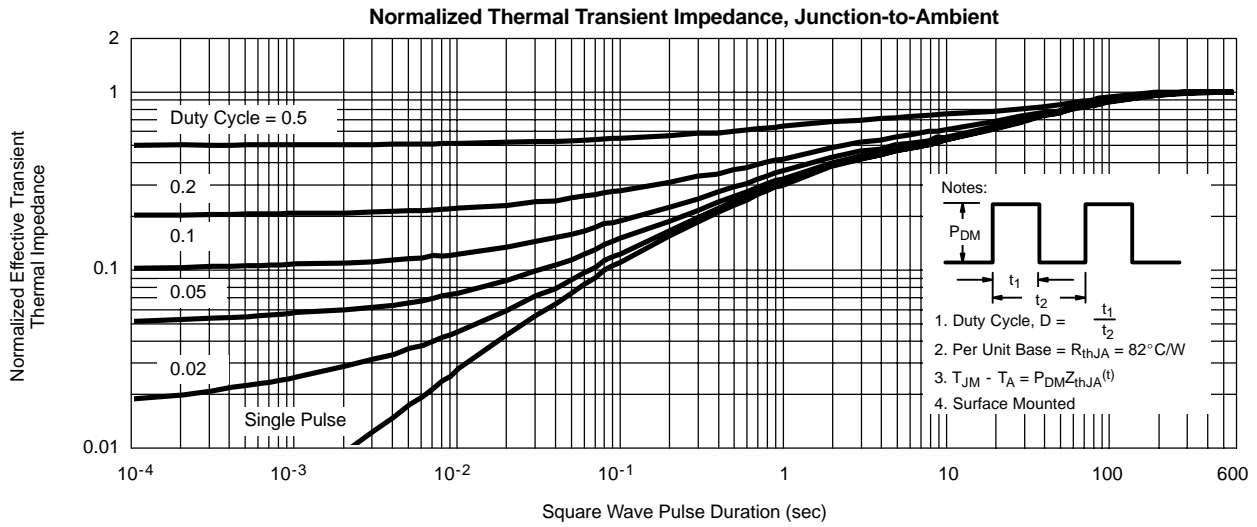

**TYPICAL CHARACTERISTICS (25 °C UNLESS NOTED)**

**SCHOTTKY**

