

Dual N-Channel 40-V (D-S) MOSFET

PRODUCT SUMMARY		
V_{DS} (V)	$r_{DS(on)}$ (Ω)	I_D (A)
40	0.021 @ $V_{GS} = 10$ V	7.4
	0.028 @ $V_{GS} = 4.5$ V	6.4

FEATURES

- TrenchFET® Power MOSFET

APPLICATIONS

- Low Power Synchronous Rectifier
- Automotive 12-V Systems

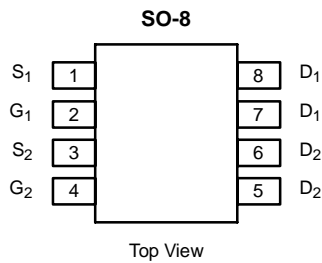

Ordering Information: Si4942DY
Si4942DY-T1 (with Tape and Reel)

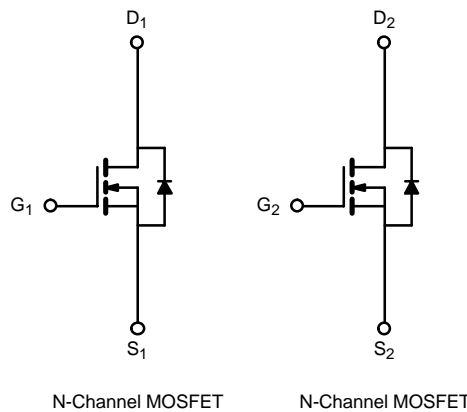

ABSOLUTE MAXIMUM RATINGS ($T_A = 25^\circ\text{C}$ UNLESS OTHERWISE NOTED)					
Parameter	Symbol	10 secs	Steady State	Unit	
Drain-Source Voltage	V_{DS}	40		V	
Gate-Source Voltage	V_{GS}	± 20			
Continuous Drain Current ($T_J = 150^\circ\text{C}$) ^a	I_D	$T_A = 25^\circ\text{C}$	7.4	5.3	A
		$T_A = 70^\circ\text{C}$	5.8	4.3	
Pulsed Drain Current	I_{DM}	30			
Avalanche Current	I_{AS}	25			
Continuous Source Current (Diode Conduction) ^a		I_S	1.8	0.9	
Maximum Power Dissipation ^a	P_D	$T_A = 25^\circ\text{C}$	2.1	1.1	W
		$T_A = 70^\circ\text{C}$	1.3	0.7	
Operating Junction and Storage Temperature Range	T_J, T_{stg}	-55 to 150		$^\circ\text{C}$	

THERMAL RESISTANCE RATINGS					
Parameter	Symbol	Typical	Maximum	Unit	
Maximum Junction-to-Ambient ^a	R_{thJA}	$t \leq 10$ sec	50	60	$^\circ\text{C/W}$
		Steady State	90	110	
Maximum Junction-to-Foot (Drain)	R_{thJF}	28	34		

Notes

a. Surface Mounted on 1" x 1" FR4 Board.

SPECIFICATIONS (T_J = 25 °C UNLESS OTHERWISE NOTED)

Parameter	Symbol	Test Condition	Min	Typ	Max	Unit
Static						
Gate Threshold Voltage	V _{GS(th)}	V _{DS} = V _{GS} , I _D = 250 μA	1.0		3	V
Gate-Body Leakage	I _{GSS}	V _{DS} = 0 V, V _{GS} = ±20 V			±100	nA
Zero Gate Voltage Drain Current	I _{DSS}	V _{DS} = 32 V, V _{GS} = 0 V			1	μA
		V _{DS} = 32 V, V _{GS} = 0 V, T _J = 55 °C			5	
On-State Drain Current ^a	I _{D(on)}	V _{DS} ≥ 5 V, V _{GS} = 10 V	30			A
Drain-Source On-State Resistance ^a	r _{DS(on)}	V _{GS} = 10 V, I _D = 7.4 A		0.017	0.021	Ω
		V _{GS} = 4.5 V, I _D = 6.4 A		0.023	0.028	
Forward Transconductance ^a	g _{fs}	V _{DS} = 15 V, I _D = 7.4 A		25		S
Diode Forward Voltage ^a	V _{SD}	I _S = 1.8 A, V _{GS} = 0 V		0.75	1.1	V
Dynamic^b						
Total Gate Charge	Q _g	V _{DS} = 20 V, V _{GS} = 10 V, I _D = 5.7 A		21	32	nC
Gate-Source Charge	Q _{gs}			3.3		
Gate-Drain Charge	Q _{gd}			5.8		
Gate Resistance	R _G		0.5	1.1	1.6	Ω
Turn-On Delay Time	t _{d(on)}	V _{DD} = 20 V, R _L = 20 Ω I _D ≅ 1 A, V _{GEN} = 10 V, R _G = 6 Ω		13	20	ns
Rise Time	t _r			10	15	
Turn-Off Delay Time	t _{d(off)}			31	50	
Fall Time	t _f			11	20	
Source-Drain Reverse Recovery Time	t _{rr}	I _F = 1.8 A, di/dt = 100 A/μs		30	60	

Notes

- a. Pulse test; pulse width ≤ 300 μs, duty cycle ≤ 2%.
b. Guaranteed by design, not subject to production testing.

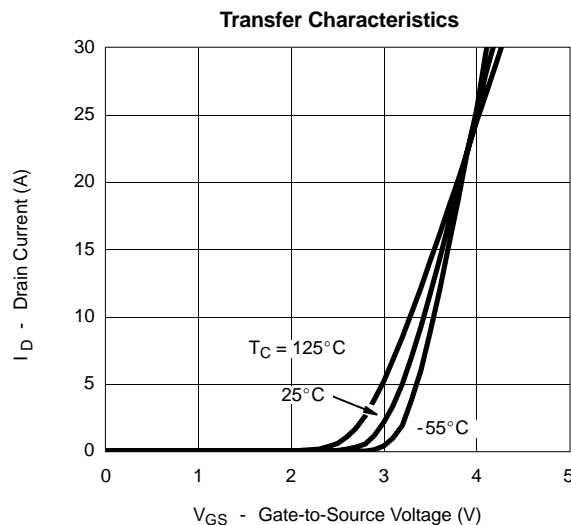
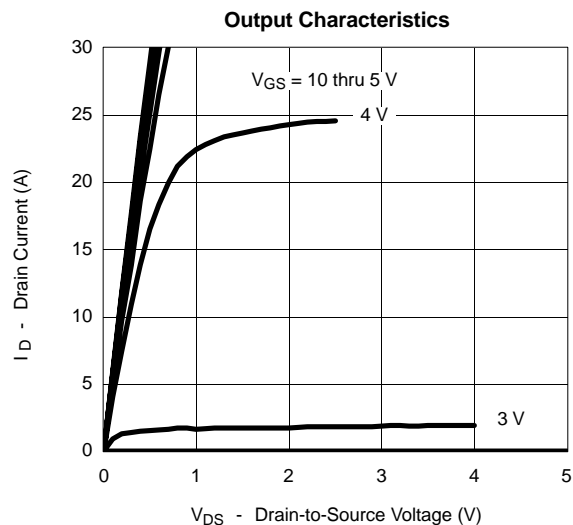
TYPICAL CHARACTERISTICS (25 °C UNLESS NOTED)

TYPICAL CHARACTERISTICS (25 °C UNLESS NOTED)

On-Resistance vs. Drain Current

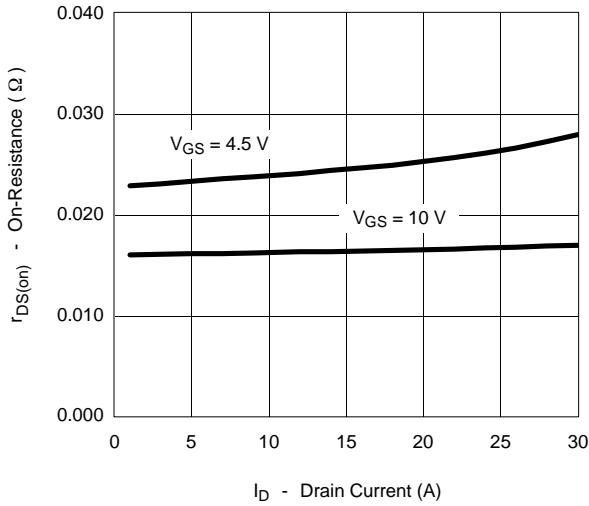

Capacitance

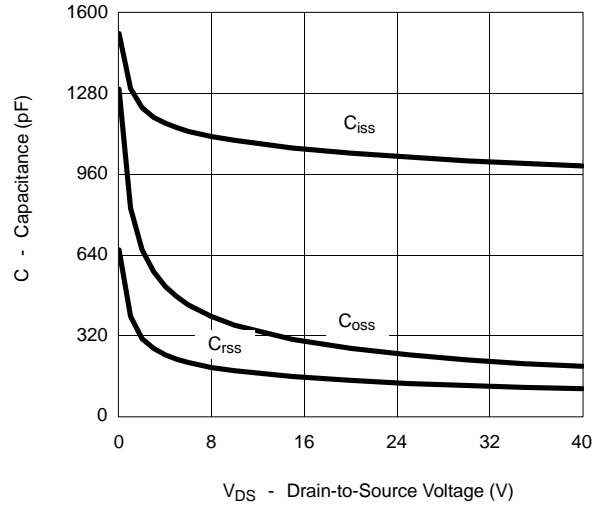

Gate Charge

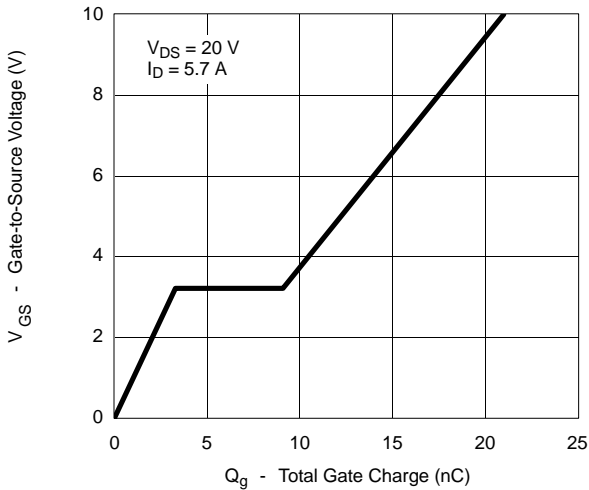

On-Resistance vs. Junction Temperature

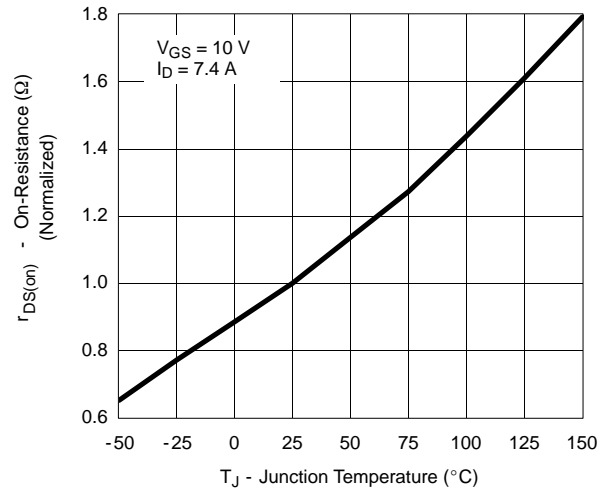

Source-Drain Diode Forward Voltage

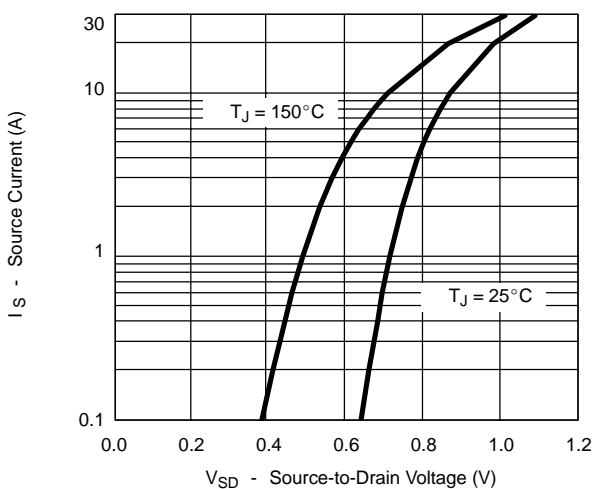

On-Resistance vs. Gate-to-Source Voltage

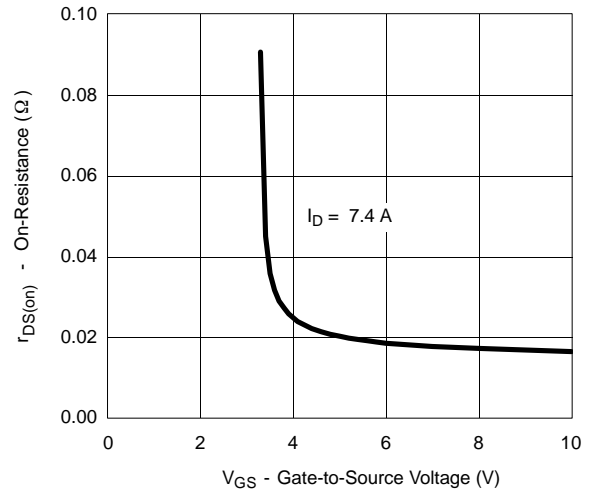

TYPICAL CHARACTERISTICS (25 °C UNLESS NOTED)

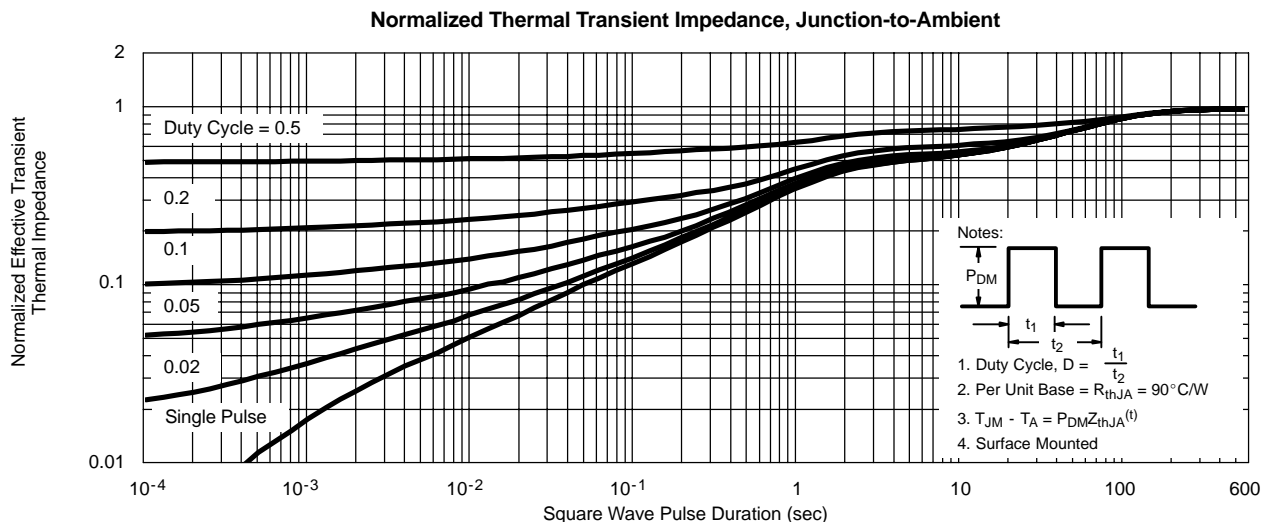
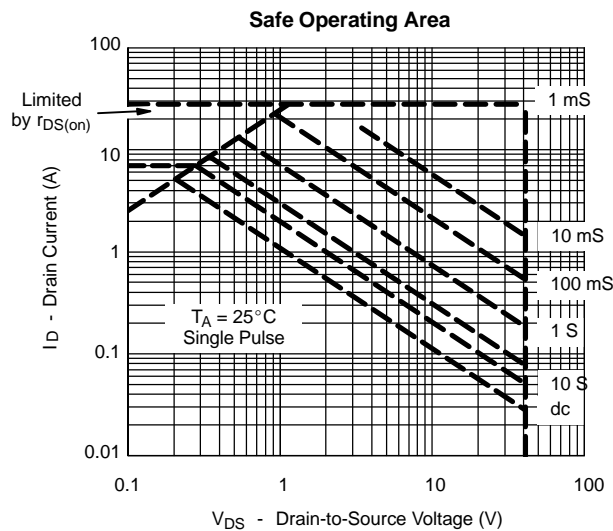
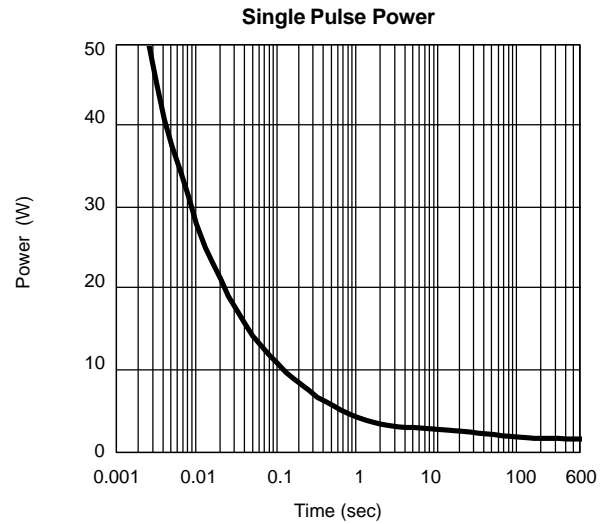
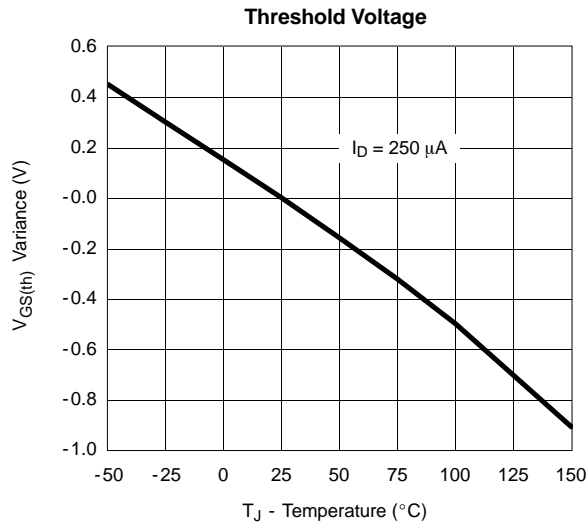



TYPICAL CHARACTERISTICS (25 °C UNLESS NOTED)

