

## Complementary 30-V (D-S) MOSFET

**TrenchFET®**  
Power MOSFETs

PRODUCT SUMMARY			
	$V_{DS}$ (V)	$r_{DS(on)}$ ( $\Omega$ )	$I_D$ (A)
N-Channel	30	0.480 @ $V_{GS} = 10$ V	0.63
		0.700 @ $V_{GS} = 4.5$ V	0.52
P-Channel	-30	0.940 @ $V_{GS} = -10$ V	-0.45
		1.700 @ $V_{GS} = -4.5$ V	-0.33

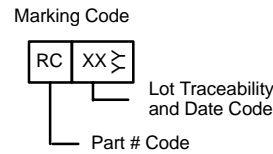
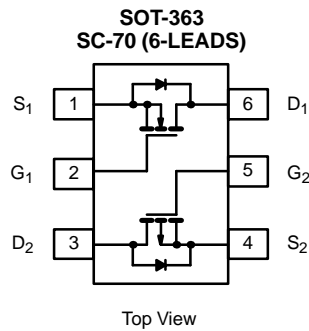

ABSOLUTE MAXIMUM RATINGS ( $T_A = 25^\circ\text{C}$ UNLESS OTHERWISE NOTED)							
Parameter	Symbol	N-Channel		P-Channel		Unit	
		5 secs	Steady State	5 secs	Steady State		
Drain-Source Voltage	$V_{DS}$	30		-30		V	
Gate-Source Voltage	$V_{GS}$	$\pm 20$					
Continuous Drain Current ( $T_J = 150^\circ\text{C}$ ) <sup>a</sup>	$T_A = 25^\circ\text{C}$	0.63	0.54	-0.45	-0.42	A	
	$T_A = 85^\circ\text{C}$	0.45	0.43	-0.32	-0.31		
Pulsed Drain Current	$I_{DM}$	1.0					
Continuous Source Current (Diode Conduction) <sup>a</sup>	$I_S$	0.25	0.23	-0.25	-0.23		
Maximum Power Dissipation <sup>a</sup>	$T_A = 25^\circ\text{C}$	0.30	0.27	0.30	0.27	W	
	$T_A = 85^\circ\text{C}$	0.16	0.14	0.16	0.14		
Operating Junction and Storage Temperature Range	$T_J, T_{stg}$	-55 to 150					

THERMAL RESISTANCE RATINGS					
Parameter		Symbol	Typical	Maximum	Unit
Maximum Junction-to-Ambient <sup>a</sup>	$t \leq 5$ sec	$R_{thJA}$	360	415	$^\circ\text{C/W}$
	Steady State		400	460	
Maximum Junction-to-Foot (Drain)	Steady State	$R_{thJF}$	300	350	

Notes  
a. Surface Mounted on 1" x 1" FR4 Board.

SPECIFICATIONS (T <sub>J</sub> = 25 °C UNLESS OTHERWISE NOTED)							
Parameter	Symbol	Test Condition		Min	Typ	Max	Unit
<b>Static</b>							
Gate Threshold Voltage	V <sub>GS(th)</sub>	V <sub>DS</sub> = V <sub>GS</sub> , I <sub>D</sub> = 250 μA	N-Ch	1.0			V
		V <sub>DS</sub> = V <sub>GS</sub> , I <sub>D</sub> = -250 μA	P-Ch	-1.0			
Gate-Body Leakage	I <sub>GSS</sub>	V <sub>DS</sub> = 0 V, V <sub>GS</sub> = ±20 V	N-Ch			±100	nA
			P-Ch			±100	
Zero Gate Voltage Drain Current	I <sub>DSS</sub>	V <sub>DS</sub> = 24 V, V <sub>GS</sub> = 0 V	N-Ch			1	μA
		V <sub>DS</sub> = -24 V, V <sub>GS</sub> = 0 V	P-Ch			-1	
		V <sub>DS</sub> = 24 V, V <sub>GS</sub> = 0 V, T <sub>J</sub> = 85 °C	N-Ch			5	
		V <sub>DS</sub> = -24 V, V <sub>GS</sub> = 0 V, T <sub>J</sub> = 85 °C	P-Ch			-5	
On-State Drain Current <sup>a</sup>	I <sub>D(on)</sub>	V <sub>DS</sub> ≥ 5 V, V <sub>GS</sub> = 10 V	N-Ch	1.0			A
		V <sub>DS</sub> ≤ -5 V, V <sub>GS</sub> = -10 V	P-Ch	-1.0			
Drain-Source On-State Resistance <sup>a</sup>	r <sub>DS(on)</sub>	V <sub>GS</sub> = 10 V, I <sub>D</sub> = 0.59 A	N-Ch		0.410	0.480	Ω
		V <sub>GS</sub> = -10 V, I <sub>D</sub> = -0.42 A	P-Ch		0.800	0.940	
		V <sub>GS</sub> = 4.5 V, I <sub>D</sub> = 0.2 A	N-Ch		0.600	0.700	
		V <sub>GS</sub> = -4.5 V, I <sub>D</sub> = -0.2 A	P-Ch		1.5	1.700	
Forward Transconductance <sup>a</sup>	g <sub>fs</sub>	V <sub>DS</sub> = 15 V, I <sub>D</sub> = 0.59 A	N-Ch		0.75		S
		V <sub>DS</sub> = -15 V, I <sub>D</sub> = -0.42 A	P-Ch		0.5		
Diode Forward Voltage <sup>a</sup>	V <sub>SD</sub>	I <sub>S</sub> = 0.23 A, V <sub>GS</sub> = 0 V	N-Ch		0.8	1.2	V
		I <sub>S</sub> = -0.23 A, V <sub>GS</sub> = 0 V	P-Ch		-0.86	-1.2	
<b>Dynamic<sup>b</sup></b>							
Total Gate Charge	Q <sub>g</sub>	<b>N-Channel</b> V <sub>DS</sub> = 15 V, V <sub>GS</sub> = 10 V, I <sub>D</sub> = 0.59 A <b>P-Channel</b> V <sub>DS</sub> = -15 V, V <sub>GS</sub> = -10 V, I <sub>D</sub> = -0.42 A	N-Ch		0.86	1.4	nC
			P-Ch		0.9	1.4	
Gate-Source Charge	Q <sub>gs</sub>		N-Ch		0.24		
			P-Ch		0.21		
Gate-Drain Charge	Q <sub>gd</sub>		N-Ch		0.08		
			P-Ch		0.17		
Turn-On Delay Time	t <sub>d(on)</sub>	<b>N-Channel</b> V <sub>DD</sub> = 15 V, R <sub>L</sub> = 30 Ω I <sub>D</sub> ≅ 0.5 A, V <sub>GEN</sub> = 10 V, R <sub>G</sub> = 6 Ω <b>P-Channel</b> V <sub>DD</sub> = -15 V, R <sub>L</sub> = 30 Ω I <sub>D</sub> ≅ -0.5 A, V <sub>GEN</sub> = -10 V, R <sub>G</sub> = 6 Ω	N-Ch		5	10	ns
			P-Ch		4	10	
Rise Time	t <sub>r</sub>		N-Ch		8	15	
			P-Ch		8	15	
Turn-Off Delay Time	t <sub>d(off)</sub>		N-Ch		8	15	
			P-Ch		5	10	
Fall Time	t <sub>f</sub>		N-Ch		7	15	
			P-Ch		7	15	
Source-Drain Reverse Recovery Time	t <sub>rr</sub>	I <sub>F</sub> = 0.23 A, di/dt = 100 A/μs	N-Ch		15	30	
		I <sub>F</sub> = -0.23 A, di/dt = 100 A/μs	P-Ch		20	40	

## Notes

- a. Pulse test; pulse width ≤ 300 μs, duty cycle ≤ 2%.  
b. Guaranteed by design, not subject to production testing.



**TYPICAL CHARACTERISTICS (25°C UNLESS NOTED)**

**N-CHANNEL**

**Output Characteristics**

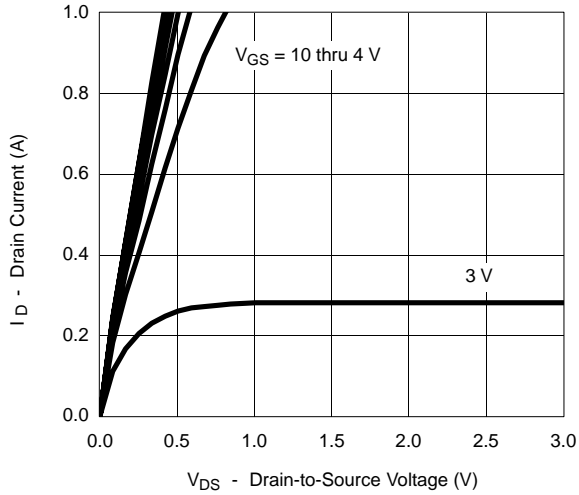

**Transfer Characteristics**

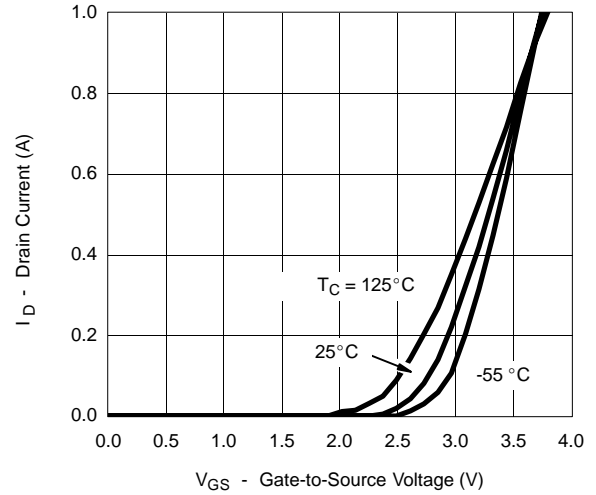

**On-Resistance vs. Drain Current**

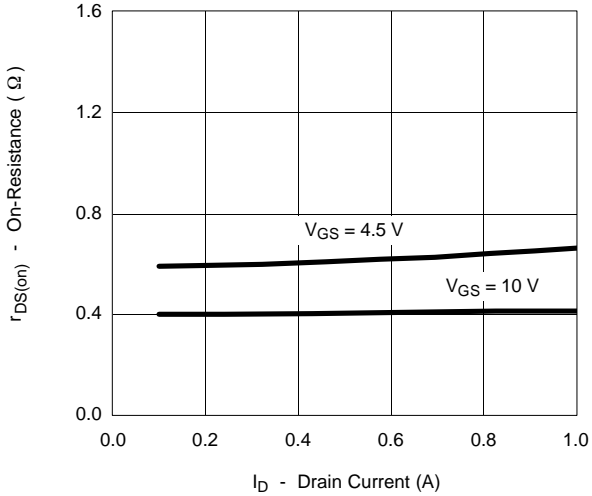

**Capacitance**

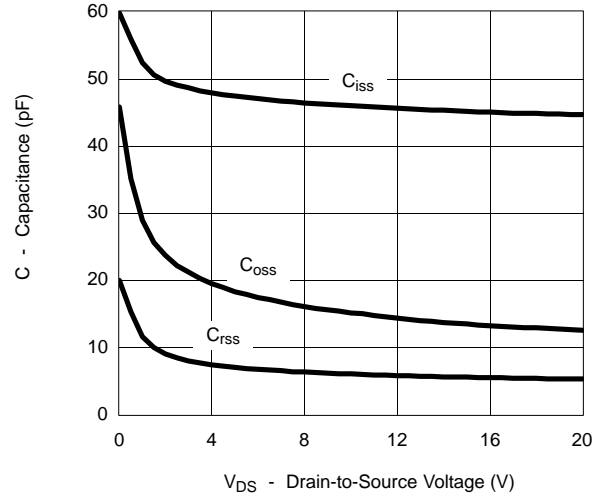

**Gate Charge**

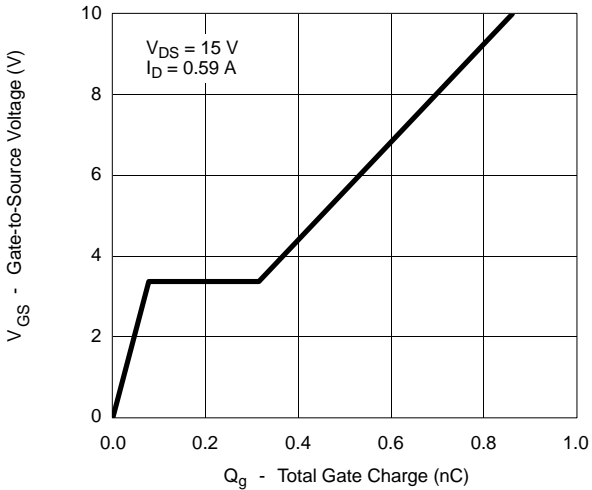

**On-Resistance vs. Junction Temperature**

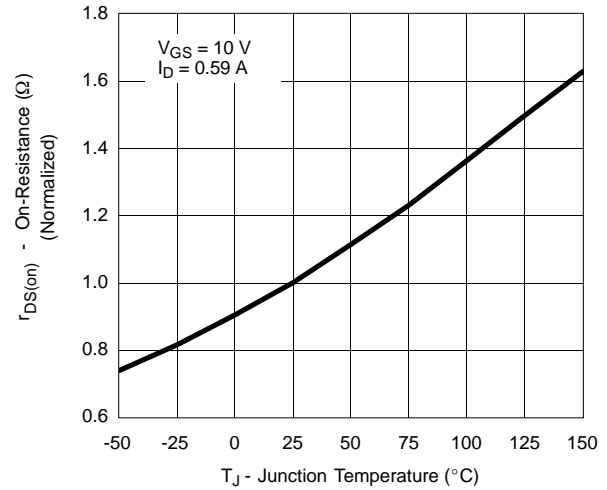

**TYPICAL CHARACTERISTICS (25 °C UNLESS NOTED) N-CHANNEL**

**Source-Drain Diode Forward Voltage**

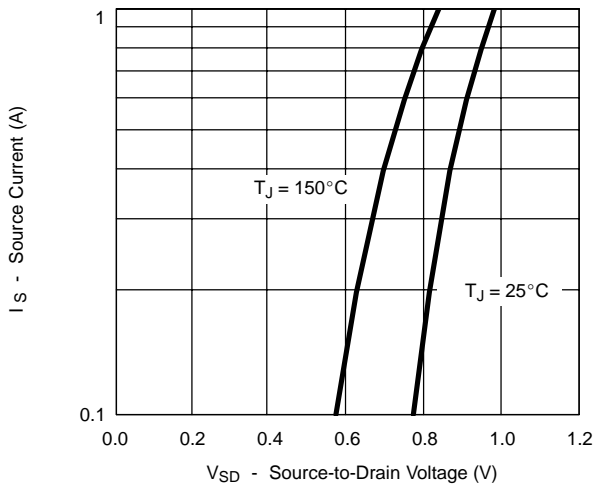

**On-Resistance vs. Gate-to-Source Voltage**

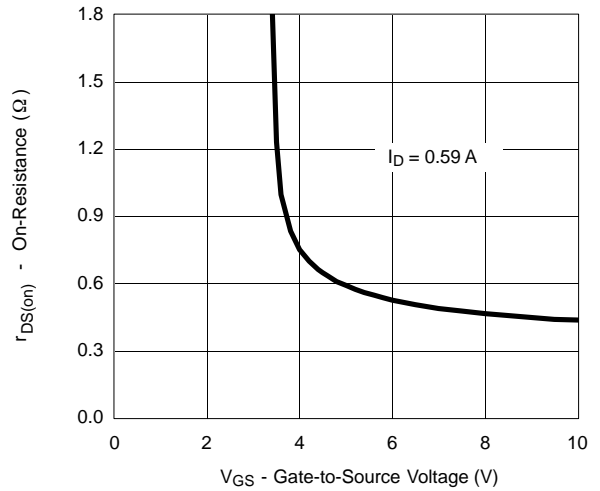

**Threshold Voltage**

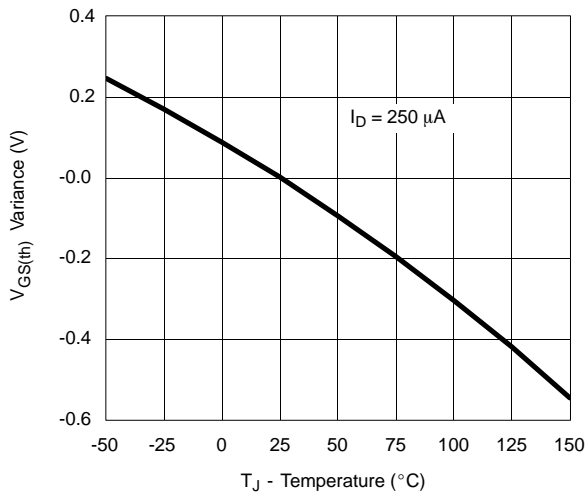

**Single Pulse Power**

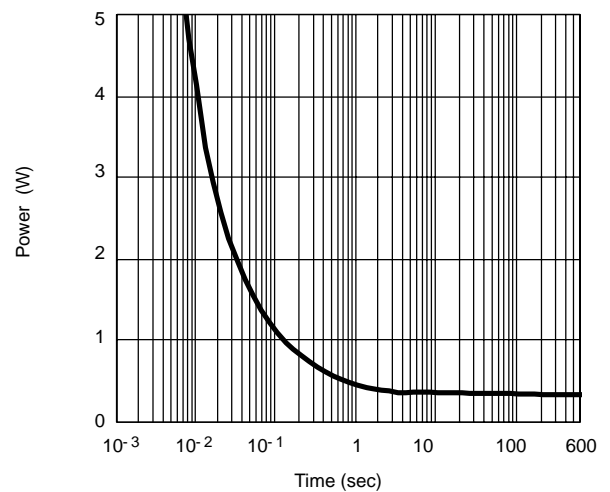

**Normalized Thermal Transient Impedance, Junction-to-Ambient**

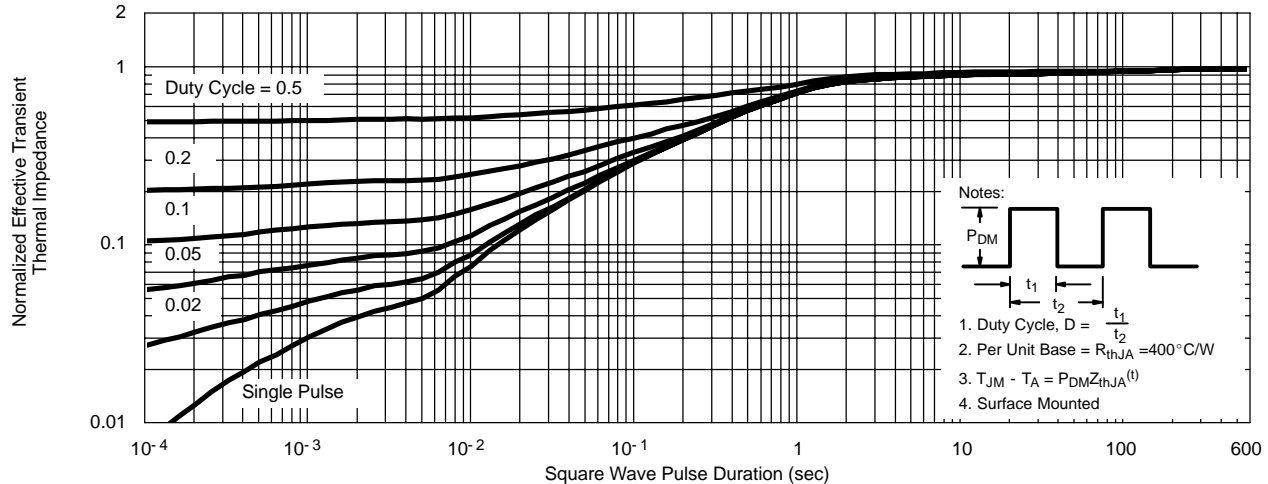



**TYPICAL CHARACTERISTICS (25°C UNLESS NOTED)**

**N-CHANNEL**

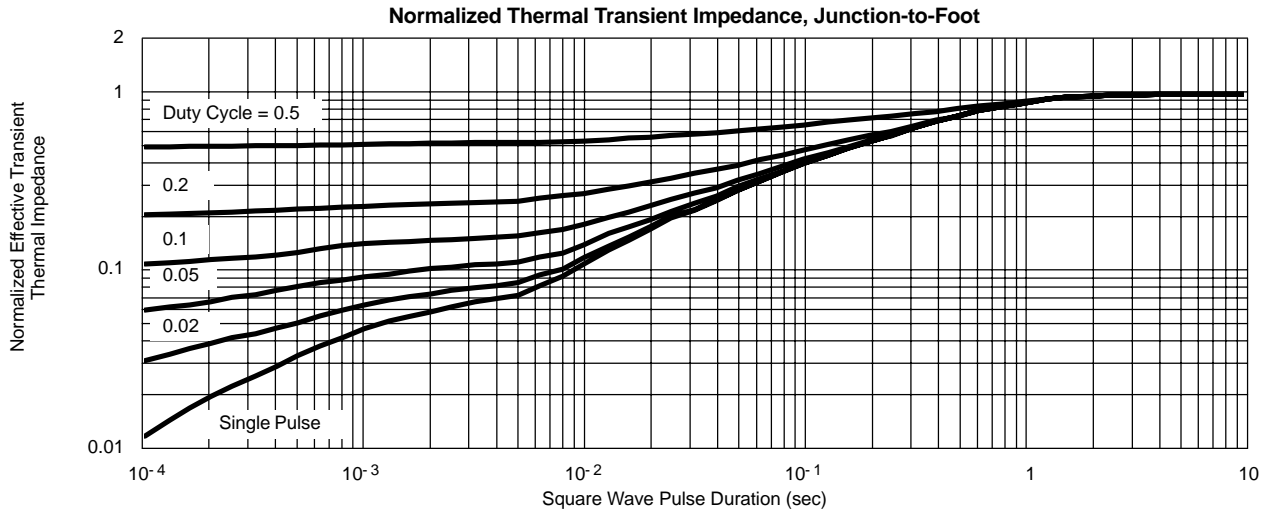

**TYPICAL CHARACTERISTICS (25°C UNLESS NOTED)**

**P-CHANNEL**

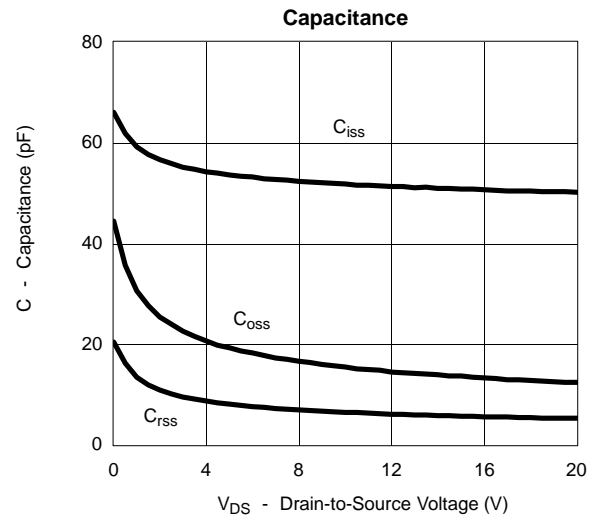
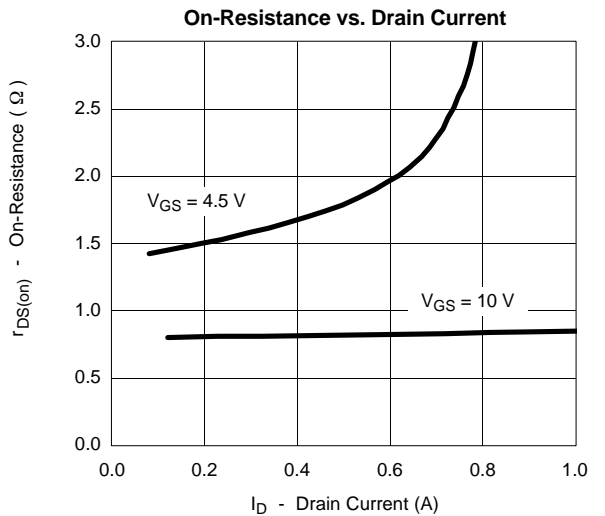
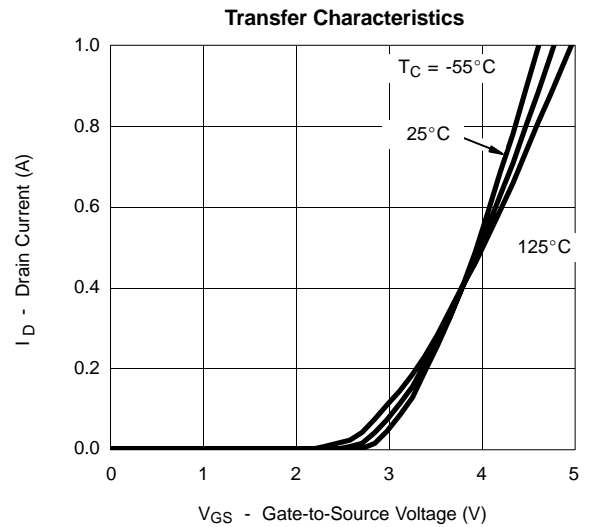
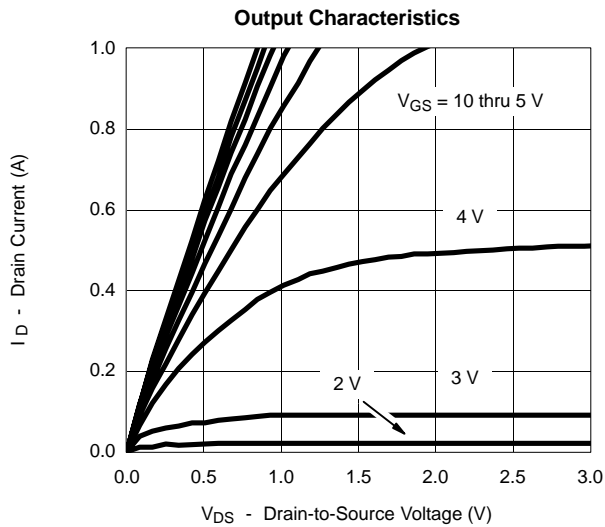

**TYPICAL CHARACTERISTICS (25 °C UNLESS NOTED) P-CHANNEL**

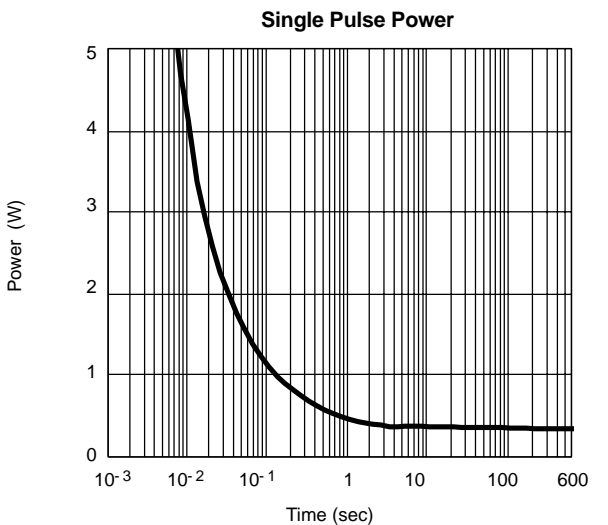
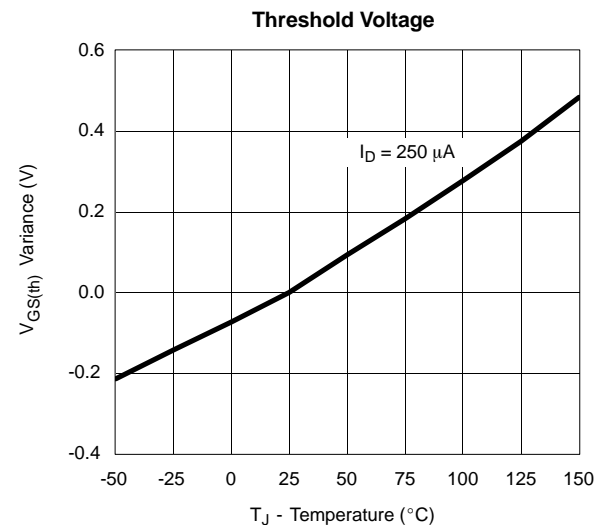
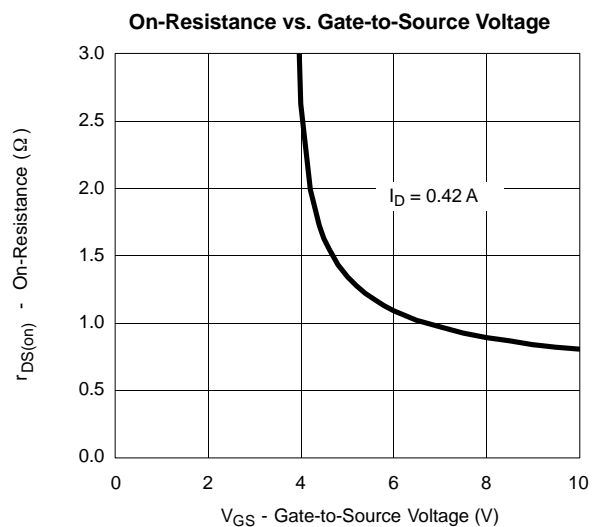
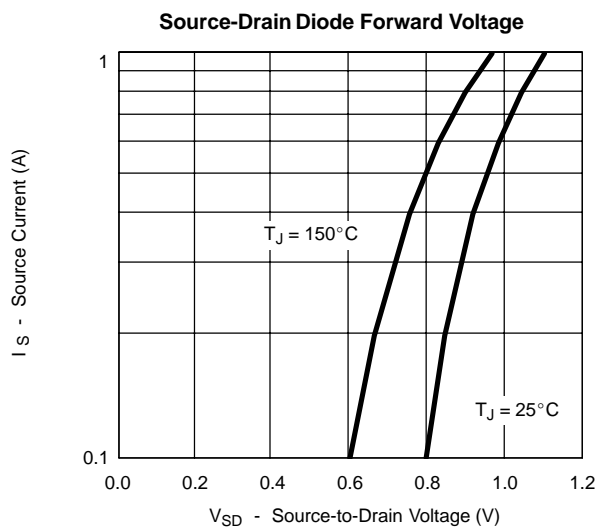
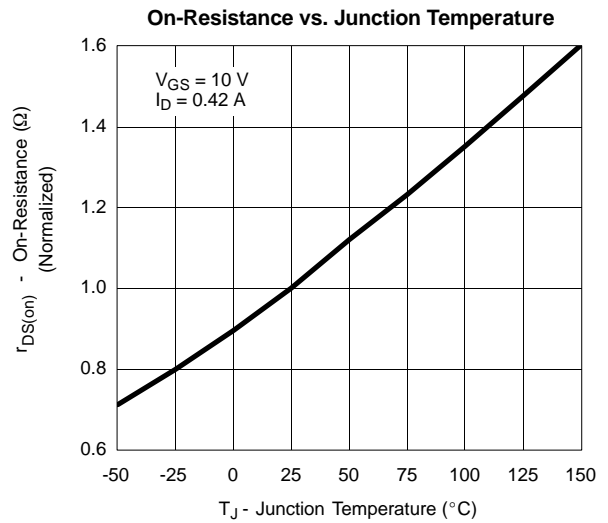
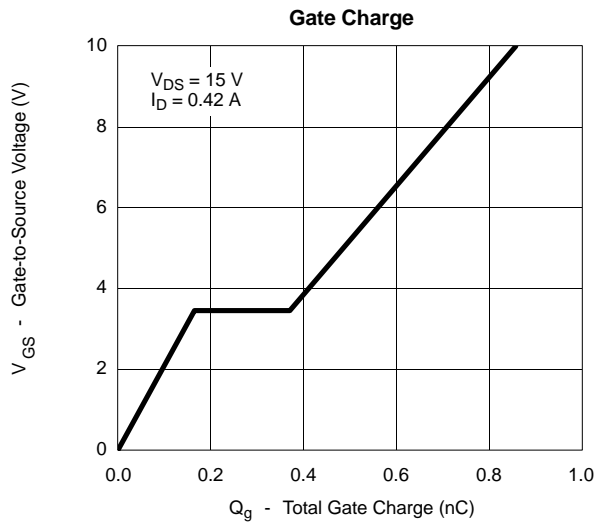

**TYPICAL CHARACTERISTICS (25°C UNLESS NOTED) P-CHANNEL**

**Normalized Thermal Transient Impedance, Junction-to-Ambient**

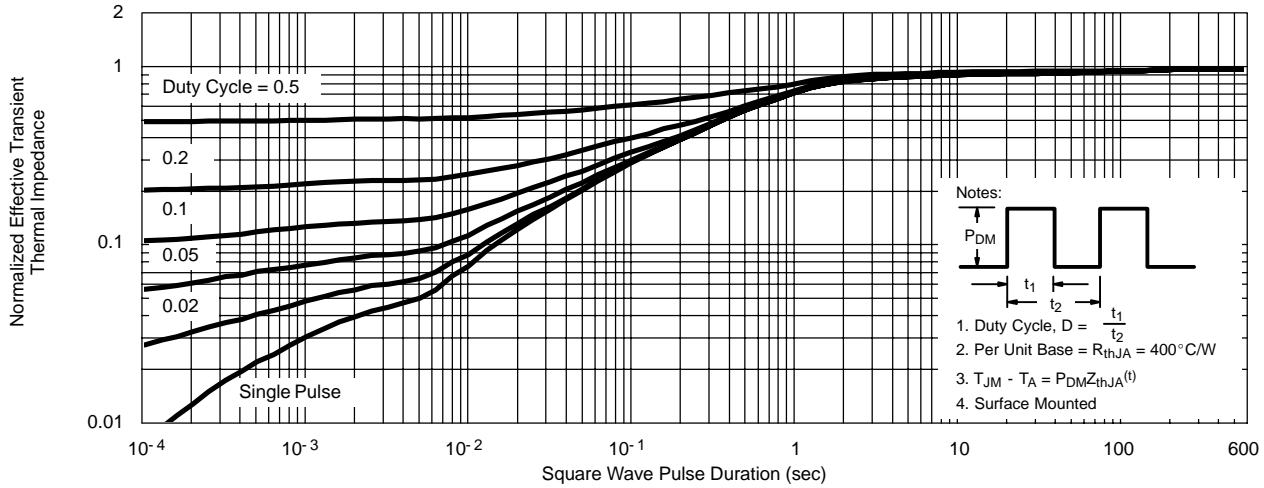

**Normalized Thermal Transient Impedance, Junction-to-Foot**

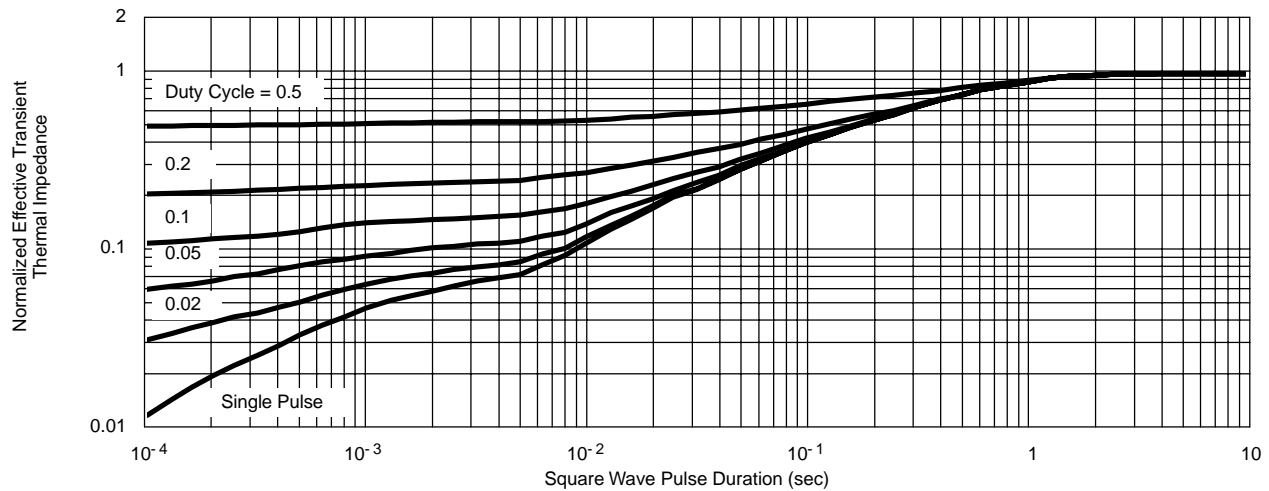



## Notice

Specifications of the products displayed herein are subject to change without notice. Vishay Intertechnology, Inc., or anyone on its behalf, assumes no responsibility or liability for any errors or inaccuracies.

Information contained herein is intended to provide a product description only. No license, express or implied, by estoppel or otherwise, to any intellectual property rights is granted by this document. Except as provided in Vishay's terms and conditions of sale for such products, Vishay assumes no liability whatsoever, and disclaims any express or implied warranty, relating to sale and/or use of Vishay products including liability or warranties relating to fitness for a particular purpose, merchantability, or infringement of any patent, copyright, or other intellectual property right.

The products shown herein are not designed for use in medical, life-saving, or life-sustaining applications. Customers using or selling these products for use in such applications do so at their own risk and agree to fully indemnify Vishay for any damages resulting from such improper use or sale.