

Electromagnetic Coupling RFID System V600

Non-contact Data Communications System

- New compact, slim Controller with two input channels added to the lineup.
- Superior environmental resistance.
- Heat-resistant Data Carrier available (150°C max.).
- Large memory capacity of 8 kbytes for Built-in-battery Data Carriers and 254 bytes for Battery-less Data Carriers.
- Built-in-battery Data Carriers have a battery life detecting function.
- Data of Battery-less Data Carriers with small memory capacity can be overwritten 300,000 times at normal temperatures.
- Thin, compact, and low-cost Data Carriers are available.
- Transmission distance of 100 mm max.
- CE marking/FCC approvals.



Ordering Information



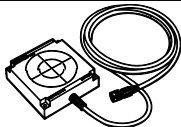

■ Data Carriers

Item		Model	Specifications/Design/Memory capacity		
Large Memory Capacity	Built-in-battery Data Carriers	V600-D8KR12		Rectangular compact 65 × 40 × 15 mm	8 Kbytes
		V600-D8KR13		Thin rectangular 86 × 54 × 10.3 mm	
		V600-D8KR04		Intermediate-range rectangular 86 × 54 × 20 mm	
	Battery-less Data Carriers	V600-D8KF04 NEW		Intermediate-range rectangular 86 × 54 × 20 mm	2 Kbytes
	Replaceable-battery Data Carriers	V600-D2KR16		Compact 65 × 40 × 5 mm	
Small Memory Capacity	Battery-less Data Carriers	V600-D23P71		Ultrathin card-type 86 × 54 × 1.5 mm	254 bytes
		V600-D23P72		Thin half-size card-type 50 × 34 × 1.5 mm	
		V600-D23P66N		Rectangular 34 × 34 × 3.5 mm	
		V600-D23P66SP		Rectangular package with PFA 95 × 36.5 × 6.5 mm	
		V600-D23P61		Rectangular compact 32 × 24 × 6 mm	
		V600-D23P53		Round super-compact 8 dia. × 5 mm	
		V600-D23P54		Round compact 12 dia. × 6 mm	
		V600-D23P55		Round super-compact 8 dia. × 5 mm	

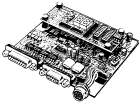

■ R/W Heads

Item		Model	Specifications/Design			
Rectangular type		V600-H07 (0.5 m)		Dimensions: 100 × 100 × 30 mm	0.5-m cable	
		V600-H07 (2 m)			2-m cable	
		V600-H07 (5 m)			5-m cable	
		V600-H07 (10 m)			10-m cable	
			V600-H11 (0.5 m)		Dimensions: 53 × 40 × 23 mm	0.5-m cable
			V600-H11-R (0.5 m)			0.5-m cable
			V600-H11 (2 m)			2-m cable
			V600-H11 (5 m)			5-m cable
			V600-H11 (10 m)			10-m cable
Cylinder type		V600-H51 (0.5 m)		Dimensions: 22 dia. × 80 mm	0.5-m cable	
		V600-H51 (2 m)			2-m cable	
		V600-H51 (5 m)			5-m cable	
		V600-H51 (10 m)			10-m cable	
			V600-H52 (0.5 m)		Dimensions: 22 dia. × 85 mm	0.5-m cable
			V600-H52 (2 m)			2-m cable
			V600-H52 (5 m)			5-m cable
			V600-H52 (10 m)			10-m cable
Separate-amplifier type	Amplifier section	V600-HA51 (2 m)		73.8 × 22.6 × 36.5 mm, with 2-m cable		
		V600-HA51 (5 m)			73.8 × 22.6 × 36.5 mm, with 5-m cable	
		V600-HA51 (10 m)			73.8 × 22.6 × 36.5 mm, with 10-m cable	
	Sensor section	V600-HS51		12 dia. × 35 mm deep, with 2-m cable		
		V600-HS61				30.5 × 18 × 10 mm, with a 2-m cable

■ ID Controllers

Item	Model	Specifications/Design		
DC Power Supply	V600-CA5D02 <i>NEW</i>		24 VDC Two R/W Head channels 105 × 90 × 65 mm	Host RS-232C, RS-422, and RS-485 interfaces
	V600-CD1D-V3		24 VDC Single R/W Head connectable 115 × 68 × 80 mm	RS-232C host interface
	V600-CM1D		24-VDC, 5-VDC 2-system input Single R/W Head connectable Board type	
DC Power Supply	V600-IDSC02		24 VDC RS-232C interface	Two R/W Heads connectable
	V600-IDSC04			Four R/W Heads connectable

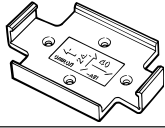
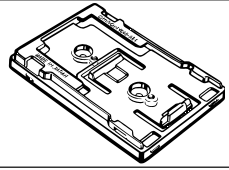
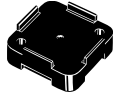

■ Accessories (Order Separately)

Item	Model	Specifications/Design		
Extension cable for R/W Heads	V600-A45	 Standard cable Non-water-resistant connectors	3-m cable	
	V600-A44		5-m cable	
	V600-A40		10-m cable	
	V600-A41		20-m cable	
	V600-A42		30-m cable	
		V600-A56	 Robotic cable Non-water-resistant connectors	3-m cable
		V600-A55		5-m cable
		V600-A50		10-m cable
		V600-A51		20-m cable
		V600-A52		30-m cable
Holder	V600-A81	 For the V600-D2KR16 *Mount with M3 flat countersunk head screws (at least two).		
	V600-A84	 For the V600-D23P71/D23P72 Ultrasonic deposition can be used on the plastic container.		
Attachment	V600-A86	 For the V600-D23P66N		

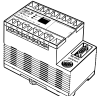
■ RS-232C Cables (Order Separately)









Model	Cable length	Compatible ID Controllers
XW2Z-200S	2 m	V600-CD1D-V3 V600-CM1D 
XW2Z-500S	5 m	

■ Connectors for ID Controllers (One Set per Unit)

Model	Name	Compatible ID Controllers
XM2A-0901	Connector Plug	V600-CD1D-V3 V600-CM1D 
XM2S-0911	Connector Hood	
MC1.5/5-STF-3.5 (made by Phoenix Contact)	RS-422/RS-485 communications connector	V600-CA5D02 





Specifications

■ Battery-less Data Carriers with Small Memory Capacity

Item	Shape	Ultrathin Card-type	Ultrathin Half-size Card-type	Rectangular Compact	Chemical-resistant	Rectangular Compact	Round Super-compact	Round Compact	Round Super-compact	
	Model	V600-D23P71 	V600-D23P72 	V600-D23P66N 	V600-D23P66SP 	V600-D23P61 	V600-D23P53 	V600-D23P54 	V600-D23P55 	
Memory capacity	254 bytes									
Memory type	EEPROM (non-volatile memory)									
Transmission distance	Refer to "Transmission Distance Specifications for Battery-less Data Carriers with Small Memory Capacity" on page 10.									
Data retention time (after writing data)	10 years		10 years (-40 to 110°C) 1 year (-40 to 150°C)		10 years			10 years (-40 to 110°C) 1 year (-40 to 150°C)		
Number of overwrites (per address) (Refer to separate item for ambient temperature)	Up to 0°C	800,000 times								
	Up to 25°C	400,000 times								
	Up to 60°C	300,000 times								
	Up to 85°C	100,000 times								
Transmission error detection	16-bit CRC in both directions (CRC: Cyclic Redundancy Check)									
Ambient temperature	For data storage	-20 to 110°C		-40 to 150°C (See note.)		-40 to 110°C		-40 to 85°C		-40 to 150°C (See note.)
	For reading/writing	-10 to 70°C		-20 to 85°C		-20 to 70°C		-25 to 70°C		-25 to 85°C
Storage temperature	-20 to 110°C		-40 to 150°C (See note.)		-40 to 110°C		-40 to 85°C		-40 to 150°C (See note.)	
Ambient humidity	Operating: 35% to 95%									
Degree of protection	IEC 60529: IP67			IEC 60529: IP68	IEC 60529: IP67	IEC 60529: IP67			IEC 60529: IP67	
Vibration resistance (destruction)	10 to 2,000 Hz, 3.0-mm double amplitude, 300 m/s ² acceleration for 30 min each in 3 directions (90 min total)			10 to 2,000 Hz, 1.5-mm double amplitude, 150 m/s ² acceleration 10 times each in 3 directions (15 min)	10 to 2,000 Hz, 3.0-mm double amplitude, 300 m/s ² acceleration for 30 min each in 3 directions (90 min total)			10 to 2,000 Hz, 1.5-mm double amplitude, 150 m/s ² acceleration 10 times each in 3 directions (15 min)		
Shock resistance (destruction)	1,000 m/s ² 3 times each in 3 directions (18 times total)			500 m/s ² 3 times each in 3 directions (18 times total)	1,000 m/s ² 3 times each in 3 directions (18 times total)			500 m/s ² 3 times each in 3 directions (18 times total)		
Weight	Approx. 15 g	Approx. 5 g	Approx. 6.5 g	Approx. 19 g	Approx. 5.8 g	Approx. 0.4 g	Approx. 1.0 g	Approx. 0.6 g		



Note: The 150°C heat resistance was confirmed by leaving the Unit at 150°C for 1,000 continuous hours, and by a thermal shock test consisting of 1,000 -10°C/150°C cycles of 30 min each. No defect was found among the 22 test samples.

■ Data Carriers with Large Memory Capacity

Shape	Built-in-battery			Battery-less	Replaceable-battery
	Rectangular Compact	Rectangular Thin	Rectangular Intermediate Range	Rectangular Intermediate Range	Rectangular Compact with Replaceable Battery
Model	V600-D8KR12 	V600-D8KR13 	V600-D8KR04 	V600-D8KF04 	V600-D2KR16 
Item					
Memory capacity	8 KB				2 KB
Memory type	SRAM (volatile memory)			FeRAM (nonvolatile memory)	SRAM (volatile memory)
Transmission distance	Refer to "Transmission Distance Specifications for Data Carriers with Large Memory Capacity (Built-in-battery/Battery-less/Replaceable-battery)" on page 15				
Battery life (See note 1.)	Refer to "Battery Life" on page 22			--- (See note 4.)	2 years (at 25°C) (See note 2.)
Number of reads/writes	Unlimited			1,000 million	Unlimited (Does not affect battery life)
Transmission error detection	16-bit CRC in both directions (CRC: Cyclic Redundancy Check)				
Ambient temperature	For data storage	-40 to 70°C			-15 to 70°C
	For reading/writing	-25 to 70°C			0 to 50°C
Storage temperature	-40 to 70°C			-15 to 70°C	
Ambient humidity	35% to 95%			35% to 85%	
Storage humidity	35% to 95%				
Degree of protection	IEC 60529: IP67				IEC 60529: IP50 (dust-proof) (See note 3.)
Vibration resistance (destruction)	10 to 500 Hz, 1.0-mm single amplitude, 150 m/s ² acceleration with 3 sweeps of 11 min each in X, Y, and Z directions			10 to 150 Hz, 0.75-mm single amplitude, 100-m/s ² acceleration for 30 min each in X, Y, and Z directions	
Shock resistance (destruction)	1,000 m/s ² 3 times each in X, Y, and Z directions (18 times total)			500 m/s ² 3 times each in X, Y, and Z directions (18 times total)	300 m/s ² 3 times each in X, Y, and Z directions (18 times total)
Weight	Approx. 70 g		Approx. 160 g	Approx. 150 g	Approx. 15 g

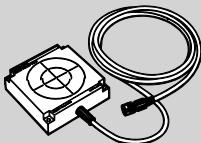
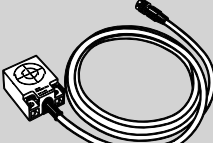

- Note:**
1. A low battery detection function is built-in.
 2. The battery life is applicable for batteries used at a temperature of 25°C. Refer to "Temperature and Battery Life" on page 22 for details on the relationship between temperature and battery life. The lithium battery is commercially available (CR2016).
 3. The Data Carrier is dustproof when the provided battery replacement cover seal is used.
 4. Data holding time: 10 years

■ Read/Write (R/W) Heads with Built-in Amplifier

Model	V600-H07	V600-H11/H11-R	V600-H51	V600-H52
Item				
Oscillation frequency	530 kHz			
Ambient temperature	-25 to 70°C		-10 to 60°C	
Storage temperature	-40 to 85°C		-25 to 75°C	
Ambient humidity	35% to 95%			
Storage humidity	35% to 95%			
Insulation resistance	50 MΩ min. (at 500 VDC) between cable terminals and case			
Dielectric strength	1,000 VAC, 50/60 Hz for 1 min between cable terminals and case (Leakage current: 1 mA max.)			
Degree of protection	IEC 60529: IP67			
Vibration resistance (destruction)	10 to 500 Hz, 1.0-mm single amplitude, 150 m/s ² acceleration with 3 sweeps of 11 min each in X, Y, and Z directions			
Shock resistance	Destruction: 500 m/s ² 3 times each in X, Y, and Z directions (18 times total)			
Cable length (See note 1.)	Standard lengths of 0.5 m, 2 m, 5 m, and 10 m.			
Wireless transmission error detection	16-bit CRC in both directions (CRC: Cyclic Redundancy Check)			
Indicators	Power: green; transmission: orange			
Weight	Approx. 1 kg (with 10-m cable)		Approx. 650 g (with 10-m cable)	

- Note:**
1. Extension cables are also available. The maximum cable length is 30.5 m for the V600-H07 and 50.5 m for the V600-H11/H51/H52.
 2. The connectors are not water-resistant.



■ Read/Write (R/W) Heads with Separate Amplifier

Model	Sensor section		Amplifier section	
	V600-HS51	V600-HS61	V600-HA51	
Item				
Oscillation frequency	530 kHz		---	
Ambient temperature	-10 to 60°C			
Storage temperature	-25 to 75°C			
Ambient humidity	35% to 95%			
Insulation resistance	50 MΩ min. (at 500 VDC) between cable terminals and case			
Dielectric strength	1,000 VAC 50/60 Hz for 1 min between cable terminals and case (Leakage current: 1 mA max.)			
Degree of protection	IEC 60529: IP67		IEC 60529: IP66	
Vibration resistance (destruction)	10 to 2,000 Hz, 1.5-mm single amplitude, 300 m/s ² acceleration with 2 sweeps of 15 min each in 3 directions		Installed in panel	10 to 2,000 Hz, 1.5-mm single amplitude, 300-m/s ² acceleration with 2 sweeps of 11 min each in 3 directions
			DIN Track installation	10 to 500 Hz, 1.0-mm single amplitude, 150-m/s ² acceleration with 3 sweeps of 11 min each in 3 directions
Shock resistance (destruction)	1,000 m/s ² 3 times each in 3 directions (18 times total)		500 m/s ² 3 times each in 3 directions (18 times total)	
Cable length	Sensor to amplifier	2 m (fixed)		---
	Amplifier to controller	---		Standard lengths of 2 m, 5 m, and 10 m (See note 1.)
Wireless transmission error detection	16-bit CRC in both directions (CRC: Cyclic Redundancy Check)			
Indicators	---		Power: green; transmission: orange	
Weight	Approx. 70 g (with 2-m cable)		Approx. 650 g (with 10-m cable)	



Note: 1. Extension cables are also available. The maximum cable length is 50 m for the V600-HA51. Extension cables are not available for the V600-HS51/HS61.

2. The connectors are not water-resistant.

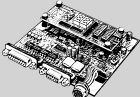





■ ID Controllers

Series Model	V600 Series		
	V600-CA5D02 	V600-CD1D-V3 	V600-CM1D 
Item			
Host interface	RS-232C, RS-422, RS-485	RS-232C	
Possible number of R/W Heads	2	1	
Power supply voltage	24 VDC	24 VDC	24 VDC, 5 VDC
Acceptable power supply voltage	20.4 to 26.4 VDC	20.4 to 26.4 VDC	20.4 to 26.4 VDC 4.5 to 5.5 VDC
Power consumption	15 W max.	7.2 W max.	24 VDC: 7.2 W max. 5 VDC: 1.5 W max.
Insulation resistance	50 MΩ min. (at 500 VDC) between power terminals and case, between I/O terminals and case, or between the power supply terminals and I/O terminals		
Dielectric strength	1,000 VAC, 50/60 Hz for 1 min between the points listed above; Leakage current: 10 mA max.	1,000 VAC, 50/60 Hz for 1 min between the points listed above; Leakage current: 10 mA max.	
Noise immunity	1,500-V (p-p) pulses of 100-ns to 1-μs pulse width with a 1-ns rise time		
Vibration resistance	Destruction	---	
	Malfunction	10 to 150 Hz, 0.2-mm double amplitude, 15 m/s ² acceleration 10 times for 8 min each in 3 directions	10 to 150 Hz, 0.2-mm double amplitude for 32 min each in X, Y, and Z directions
Shock resistance	Destruction	---	
	Malfunction	150 m/s ² 3 times each in X, Y, and Z directions (18 times total)	Destruction: 200 m/s ² 3 times each in X, Y, and Z directions (18 times total)
Ambient temperature	-10 to 55°C		0 to 50°C
Ambient humidity	35% to 85% (with no condensation)		
Operating conditions	No corrosive gases		
Storage temperature	-25 to 65°C		-15 to 70°C
Memory back-up	A capacitor backs up the most recent error data and statistical error data for up to 20 days (at 25°C) after a power interruption.	Memory backup is not available. Error details, however, can be read from the personal computer when the power is turned ON.	
Diagnostic functions	Checks for CPU errors, memory errors, power interruptions, and transmission errors		
Ground	Ground to 100 Ω or less.		
Degree of protection	IEC 60529: IP30 (panel mounted)		
Weight	Approx. 300 g	Approx 360 g	Approx. 180 g



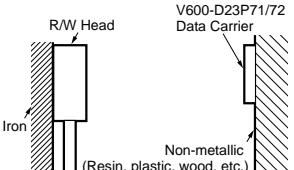



■ V600-IDSC

Item	Series Model	V600-IDSC Series	
		V600-IDSC02 	V600-IDSC04 
Host interface	RS-232C		
Possible number of R/W Heads	2	4	
Power supply voltage	24 VDC		
Acceptable power supply voltage	19.2 to 28.8 VDC		
Power consumption	50 W max.		
Insulation resistance	20 MΩ min. (at 500 VDC) between power supply terminals and frame ground terminals		
Dielectric strength	1,000 VAC, 50/60 Hz for 1 min between power supply terminals and frame ground terminals with a detected current of 10 mA max.		
Vibration resistance	10 to 50 Hz, 0.075-mm amplitude, 57 to 150 Hz, 9.8 m/s ² acceleration for 10 sweeps each in X, Y, and Z directions		
Shock resistance	147 m/s ² 3 times each in X, Y, and Z directions		
Ambient temperature	0 to 55°C (with no icing)		
Ambient humidity	10% to 90% (with no condensation)		
Storage temperature	-20 to 75°C (with no icing)		
Storage humidity	10% to 90% (with no condensation)		
Ground	Ground to 100 Ω or less.		Ground to 100 Ω or less.
Construction	Installed in panel		Installed in panel
Weight	Approx. 700 g		Approx. 800 g



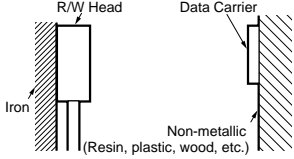

■ Transmission Distance Specifications for Battery-less Data Carriers with Small Memory Capacity

Recommended combinations		Installation		Controller mode	Transmission distance	Condition for DC and R/W head installation		
Data Carrier	R/W Head							
		Stationary	Read distance	Irrelevant	10 to 70 mm (max. axial offset ± 10 mm)	These Data Carriers are for installation on non-metallic surfaces only. 		
			Write distance					
		Moving	Read distance		30 to 60 mm (max. axial offset ± 10 mm)			
			Write distance					
	V600-H11/-H11-R		Stationary		Read distance		Irrelevant	5 to 40 mm (max. axial offset ± 10 mm)
					Write distance			
Moving	Read distance		15 to 40 mm (max. axial offset ± 10 mm)					
	Write distance							
		Stationary	Read distance	Irrelevant	10 to 50 mm (max. axial offset ± 10 mm)			
			Write distance					
		Moving	Read distance		30 to 40 mm (max. axial offset ± 10 mm)			
			Write distance					
	V600-H11/-H11-R		Stationary		Read distance	Irrelevant	5 to 30 mm (max. axial offset ± 10 mm)	
					Write distance			
Moving	Read distance		15 to 30 mm (max. axial offset ± 10 mm)					
	Write distance							





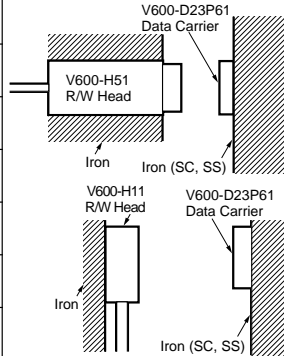



- Note:**
1. The transmission distance/transmission time priority mode setting can be made using the lower-level transmission mode setting switch or memory switch only with a Serial-interface Controller or ID Sensor Unit.
 2. With Parallel-interface Controllers, the mode setting is always transmission distance priority.
 3. The specifications take fluctuations in ambient temperature and slight differences between products into account.

Recommended combinations		Installation		Controller mode	Transmission distance	Condition for DC and R/W head installation
Data Carrier	R/W Head					
		Stationary	Read distance	Transmission distance priority	5 to 45 mm (max. axial offset ±10 mm)	 <p>Data transmission will be impossible if the DC is installed directly on a metal surface. Refer to the <i>V600 R/W Heads and EEPROM Data Carriers Operation Manual</i> (Cat. No. Z128) for details.</p>
				Transmission time priority	5 to 35 mm (max. axial offset ±10 mm)	
			Write distance	Irrelevant	5 to 35 mm (max. axial offset ±10 mm)	
		Moving	Read distance	Transmission distance priority	25 to 40 mm (max. axial offset ±10 mm)	
				Transmission time priority	25 to 30 mm (max. axial offset ±10 mm)	
			Write distance	Irrelevant	25 to 30 mm (max. axial offset ±10 mm)	
		Stationary	Read distance	Transmission distance priority	5 to 30 mm (max. axial offset ±10 mm)	
				Transmission time priority	5 to 25 mm (max. axial offset ±10 mm)	
			Write distance	Irrelevant	5 to 25 mm (max. axial offset ±10 mm)	
		Moving	Read distance	Transmission distance priority	15 to 25 mm (max. axial offset ±10 mm)	
				Transmission time priority	15 to 20 mm (max. axial offset ±10 mm)	
			Write distance	Irrelevant	15 to 20 mm (max. axial offset ±10 mm)	
		Stationary	Read distance	Transmission distance priority	5 to 40 mm (max. axial offset ±10 mm)	
				Transmission time priority	5 to 30 mm (max. axial offset ±10 mm)	
			Write distance	Irrelevant	5 to 30 mm (max. axial offset ±10 mm)	
		Moving	Read distance	Transmission distance priority	20 to 40 mm (max. axial offset ±10 mm)	
				Transmission time priority	20 to 30 mm (max. axial offset ±10 mm)	
			Write distance	Irrelevant	20 to 30 mm (max. axial offset ±10 mm)	
		Stationary	Read distance	Transmission distance priority	5 to 25 mm (max. axial offset ±10 mm)	
				Transmission time priority	5 to 20 mm (max. axial offset ±10 mm)	
			Write distance	Irrelevant	5 to 20 mm (max. axial offset ±10 mm)	
		Moving	Read distance	Transmission distance priority	10 to 25 mm (max. axial offset ±10 mm)	
				Transmission time priority	10 to 20 mm (max. axial offset ±10 mm)	
			Write distance	Irrelevant	10 to 20 mm (max. axial offset ±10 mm)	

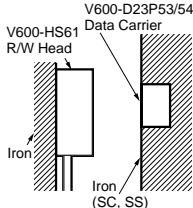
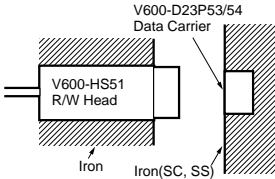
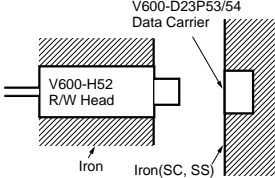



- Note:**
1. The transmission distance/transmission time priority mode setting can be made using the lower-level transmission mode setting switch or memory switch only with a Serial-interface Controller or ID Sensor Unit.
 2. With Parallel-interface Controllers, the mode setting is always transmission distance priority.
 3. The specifications take fluctuations in ambient temperature and slight differences between products into account.

Recommended combinations		Installation		Controller mode	Transmission distance	Condition for DC and R/W head installation
Data Carrier	R/W Head					
V600-D23P61 	V600-H11/-H11-R 	Stationary	Read distance	Transmission distance priority	2 to 19 mm (max. axial offset ±10 mm)	 <p>These Data Carriers can be installed on metallic surfaces.</p>
			Write distance	Irrelevant	2 to 16 mm (max. axial offset ±10 mm)	
		Moving	Read distance	Transmission distance priority	12 to 19 mm (max. axial offset ±10 mm)	
			Write distance	Irrelevant	12 to 16 mm (max. axial offset ±10 mm)	
	V600-H51 	Stationary	Read distance	Transmission distance priority	1 to 16 mm (max. axial offset ±10 mm)	
			Write distance	Irrelevant	1 to 14 mm (max. axial offset ±10 mm)	
		Moving	Read distance	Transmission distance priority	7 to 16 mm (max. axial offset ±10 mm)	
			Write distance	Irrelevant	7 to 14 mm (max. axial offset ±10 mm)	

- Note:**
1. The transmission distance/transmission time priority mode setting can be made using the lower-level transmission mode setting switch or memory switch only with a Serial-interface Controller or ID Sensor Unit.
 2. With Parallel-interface Controllers, the mode setting is always transmission distance priority.
 3. The specifications take fluctuations in ambient temperature and slight differences between products into account.

Recommended combinations		Installation		Controller mode	Transmission distance		Condition for DC and R/W head installation
Data Carrier	R/W Head						
	V600-HS51 (See note 4.) 	Stationary	Read distance	Transmission distance priority	0.5 to 4.0 mm (max. axial offset ±2 mm)	0.5 to 4.5 mm (max. axial offset ±1 mm)	<p>These Data Carriers are for flush mounting in metallic bases only.</p>   
				Transmission time priority	0.5 to 3.0 mm (max. axial offset ±2 mm)	0.5 to 3.5 mm (max. axial offset ±1 mm)	
			Write distance	Irrelevant	0.5 to 3.0 mm (max. axial offset ±2 mm)	0.5 to 3.5 mm (max. axial offset ±1 mm)	
	V600-HS61 (See note 4.) 	Stationary	Read distance	Transmission distance priority	0.5 to 4.0 mm (max. axial offset ±2 mm)	0.5 to 4.5 mm (max. axial offset ±1 mm)	
				Transmission time priority	0.5 to 3.0 mm (max. axial offset ±2 mm)	0.5 to 3.5 mm (max. axial offset ±1 mm)	
			Write distance	Irrelevant	0.5 to 3.0 mm (max. axial offset ±2 mm)	0.5 to 3.5 mm (max. axial offset ±1 mm)	
	V600-H52 	Stationary	Read distance	Transmission distance priority	0.5 to 4.0 mm (max. axial offset ±2 mm)	0.5 to 4.5 mm (max. axial offset ±1 mm)	
				Transmission time priority	0.5 to 3.0 mm (max. axial offset ±2 mm)	0.5 to 3.5 mm (max. axial offset ±1 mm)	
			Write distance	Irrelevant	0.5 to 3.0 mm (max. axial offset ±2 mm)	0.5 to 3.5 mm (max. axial offset ±1 mm)	
	V600-HS51 (See note 4.) 	Stationary	Read distance	Transmission distance priority	0.5 to 6.0 mm (max. axial offset ±2 mm)	0.5 to 6.5 mm (max. axial offset ±1 mm)	<p>The listed transmission distances also apply for installation on non-metallic surfaces. Refer to the <i>V600 R/W Heads and EEPROM Data Carriers Operation Manual</i> (Cat. No. Z128) for details.</p>
				Transmission time priority	0.5 to 5.5 mm (max. axial offset ±2 mm)	0.5 to 6.0 mm (max. axial offset ±1 mm)	
			Write distance	Irrelevant	0.5 to 5.0 mm (max. axial offset ±2 mm)	0.5 to 5.5 mm (max. axial offset ±1 mm)	
	V600-HS61 (See note 4.) 	Stationary	Read distance	Transmission distance priority	0.5 to 6.5 mm (max. axial offset ±2 mm)	0.5 to 7.0 mm (max. axial offset ±1 mm)	
				Transmission time priority	0.5 to 5.5 mm (max. axial offset ±2 mm)	0.5 to 6.0 mm (max. axial offset ±1 mm)	
			Write distance	Irrelevant	0.5 to 5.5 mm (max. axial offset ±2 mm)	0.5 to 6.0 mm (max. axial offset ±1 mm)	
	V600-H52 	Stationary	Read distance	Transmission distance priority	0.5 to 6.5 mm (max. axial offset ±2 mm)	0.5 to 7.0 mm (max. axial offset ±1 mm)	
				Transmission time priority	0.5 to 5.5 mm (max. axial offset ±2 mm)	0.5 to 6.0 mm (max. axial offset ±1 mm)	
			Write distance	Irrelevant	0.5 to 5.5 mm (max. axial offset ±2 mm)	0.5 to 6.0 mm (max. axial offset ±1 mm)	

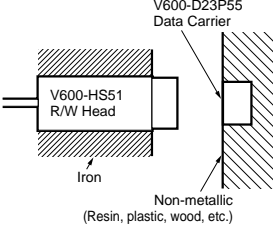
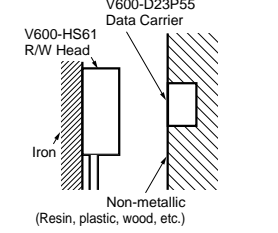
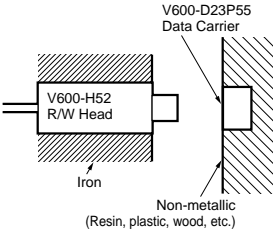







- Note:**
1. The transmission distance/transmission time priority mode setting can be made using the lower-level transmission mode setting switch or memory switch only with a Serial-interface Controller or ID Sensor Unit.
 2. With Parallel-interface Controllers, the mode setting is always transmission distance priority.
 3. The specifications take fluctuations in ambient temperature and slight differences between products into account.
 4. This is the transmission distance when using the V600-HS□1 and V600-HA51 combination.



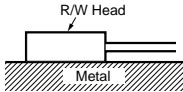
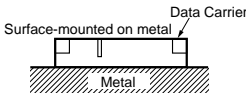

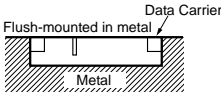
Recommended combinations		Installation		Controller mode	Transmission distance	Condition for DC and R/W head installation
Data Carrier	R/W Head					
V600-D23P55 	V600-HS51 (See note 4.) 	Stationary	Read distance	Transmission distance priority	0.5 to 6.5 mm (max. axial offset ±2 mm)	<p>These Data Carriers are for flush mounting in non-metallic bases only.</p>   
				Transmission time priority	0.5 to 6.0 mm (max. axial offset ±2 mm)	
			Write distance	Transmission distance priority	0.5 to 6.5 mm (max. axial offset ±2 mm)	
				Transmission time priority	0.5 to 6.0 mm (max. axial offset ±2 mm)	
V600-HS61 (See note 4.) 	Stationary	Read distance	Transmission distance priority	0.5 to 7.0 mm (max. axial offset ±2 mm)		
			Transmission time priority	0.5 to 6.0 mm (max. axial offset ±2 mm)		
		Write distance	Transmission distance priority	0.5 to 7.0 mm (max. axial offset ±2 mm)		
			Transmission time priority	0.5 to 6.0 mm (max. axial offset ±2 mm)		
V600-H52 	Stationary	Read distance	Transmission distance priority	0.5 to 9.0 mm (max. axial offset ±2 mm)		
			Transmission time priority	0.5 to 8.5 mm (max. axial offset ±2 mm)		
		Write distance	Transmission distance priority	0.5 to 8.5 mm (max. axial offset ±2 mm)		
			Transmission time priority	0.5 to 8.5 mm (max. axial offset ±2 mm)		

The transmission distance decreases considerably when flush mounted in non-metallic bases. Refer to the *V600 R/W Heads and EEPROM Data Carriers Operation Manual* (Cat. No. Z128) for details.

- Note:**
1. The transmission distance/transmission time priority mode setting can be made using the lower-level transmission mode setting switch or memory switch only with a Serial-interface Controller or ID Sensor Unit.
 2. With Parallel-interface Controllers, the mode setting is always transmission distance priority.
 3. The specifications take fluctuations in ambient temperature and slight differences between products into account.
 4. This is the transmission distance when using the V600-HS□1 and V600-HA51 combination.

■ Transmission Distance Specifications for Data Carriers with Large Memory Capacity (Built-in-battery/Battery-less/Replaceable-battery)

Recommended combinations		Installation		Controller mode	Transmission distance	Condition for DC and R/W head installation	
Data Carrier	R/W Head						
		Stationary	Flush-mounted in metal	Irrelevant	10 to 50 mm (max. axial offset ±10 mm)	 	
			Surface-mounted on metal		10 to 60 mm (max. axial offset ±10 mm)		
		Moving	Flush-mounted in metal		25 to 50 mm (max. axial offset ±10 mm)		
			Surface-mounted on metal		25 to 60 mm (max. axial offset ±10 mm)		
		Stationary	Flush-mounted in metal		Irrelevant	5 to 40 mm (max. axial offset ±10 mm)	 <p>The listed transmission distances also apply for installation on non-metallic surfaces. Refer to the <i>V600 R/W Heads and SRAM Data Carriers Operation Manual</i> (Cat. No. Z127) for details.</p>
			Surface-mounted on metal			5 to 45 mm (max. axial offset ±10 mm)	
		Moving	Flush-mounted in metal			25 to 40 mm (max. axial offset ±10 mm)	
			Surface-mounted on metal			25 to 45 mm (max. axial offset ±10 mm)	
		Stationary	Flush-mounted in metal	Irrelevant	10 to 30 mm (max. axial offset ±10 mm)		
			Surface-mounted on metal		10 to 35 mm (max. axial offset ±10 mm)		
		Moving	Flush-mounted in metal		20 to 30 mm (max. axial offset ±10 mm)		
			Surface-mounted on metal		20 to 35 mm (max. axial offset ±10 mm)		
		Stationary	Flush-mounted in metal		Irrelevant	10 to 30 mm (max. axial offset ±10 mm)	
			Surface-mounted on metal				
		Moving	Flush-mounted in metal			15 to 30 mm (max. axial offset ±10 mm)	
			Surface-mounted on metal				

Recommended combinations		Installation		Controller mode	Transmission distance	Condition for DC and R/W head installation	
Data Carrier	R/W Head						
V600-D8KR04 (unsealed) 	V600-H07 	Stationary	Flush-mounted in metal	Irrelevant	See note 1.	The listed transmission distances also apply for installation on non-metallic surfaces. Refer to the <i>V600 R/W Heads and SRAM Data Carriers Operation Manual</i> (Cat. No. Z127) for details.	
			Surface-mounted on metal		10 to 100 mm (max. axial offset ±10 mm)		
		Moving	Flush-mounted in metal		See note 1.		
			Surface-mounted on metal		50 to 100 mm (max. axial offset ±10 mm)		
	V600-H11 	Stationary	Flush-mounted in metal		Irrelevant		See note 1.
			Surface-mounted on metal				10 to 65 mm (max. axial offset ±10 mm)
		Moving	Flush-mounted in metal				See note 1.
			Surface-mounted on metal				30 to 65 mm (max. axial offset ±10 mm)
V600-D8KF04 	V600-H07 	Stationary	Flush-mounted in metal	Irrelevant		See note 1.	
			Surface-mounted on metal			10 to 50 mm (max. axial offset ±10 mm)	
		Moving	Flush-mounted in metal			See note 1.	
			Surface-mounted on metal			25 to 50 mm (max. axial offset ±10 mm)	
	V600-H11 	Stationary	Flush-mounted in metal		Irrelevant	See note 1.	
			Surface-mounted on metal			10 to 32 mm (max. axial offset ±10 mm)	
		Moving	Flush-mounted in metal			See note 1.	
			Surface-mounted on metal			15 to 32 mm (max. axial offset ±10 mm)	
V600-D2KR16 	V600-H11 	Stationary	Flush-mounted in metal	Irrelevant		2 to 15 mm (max. axial offset ±10 mm) (See note 2.)	
			Surface-mounted on metal			2 to 15 mm (max. axial offset ±10 mm)	
		Moving	Flush-mounted in metal			6 to 15 mm (max. axial offset ±10 mm) (See note 2.)	
			Surface-mounted on metal			10 to 15 mm (max. axial offset ±10 mm)	

Note: 1. When Data Carriers are flush-mounted in metal, the read/write distance will depend on the distance (x) between the side of the DC and the metal surface.

2. Use the following method for flush mounting into a metallic base.

Refer to the *V600 R/W Heads and SRAM Data Carriers Operation Manual* (Cat. No. Z127) for details.

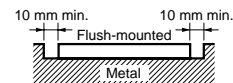
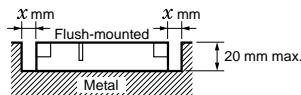

■ Influence of Surrounding Metal

V600-D8KR04 Combined with V600-H07

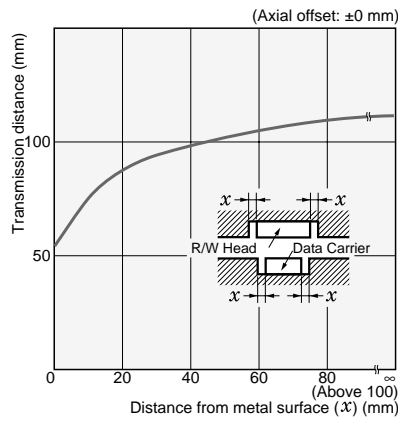

V600-D8KR04 Combined with V600-H11

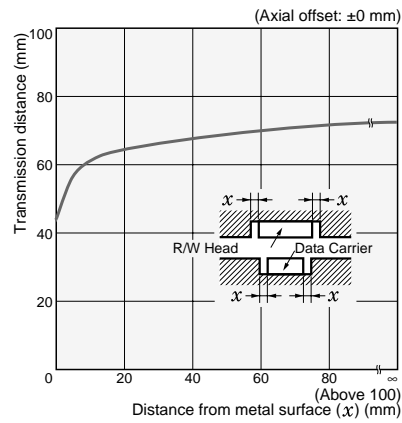

V600-D8KF04 Combined with V600-H07

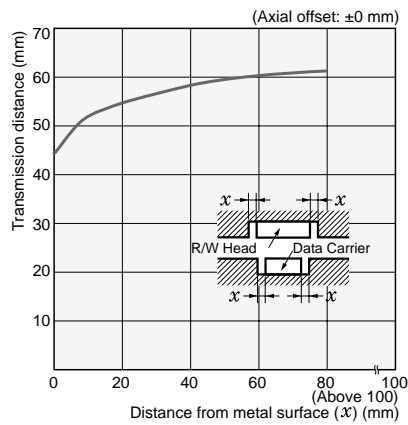

V600-D8KF04 Combined with V600-H11

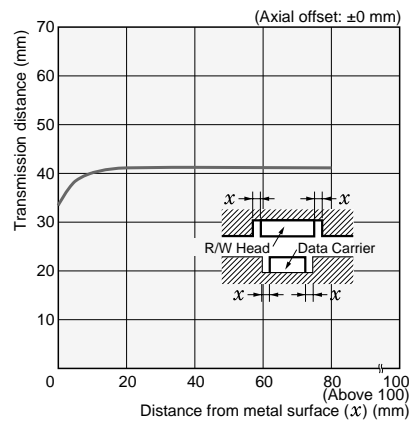

Lower-level Communications Mode Setting (Distance/Time Priority)

The lower-level communications mode is set with the DIP Switch or memory switch on the Serial-interface Controller (V600-CA5D02, V600-CD1D-V3, V600-CM1D) or ID Sensor Unit. (Refer to the Controller's operation manual for more details on the setting.)

Characteristic Data (Typical)

Transmission Range

Note: The values shown in the following graphs are in millimeters. Refer to pages 10 to 16 for details on Data Carrier and R/W Head mounting conditions.

Battery-less Data Carriers with Small Memory Capacity

V600-D23P71 & V600-H07

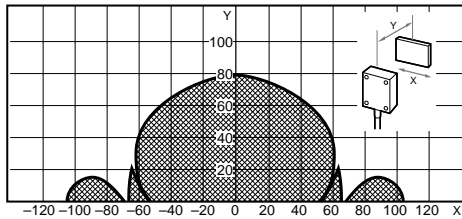

V600-D23P71 & V600-H11

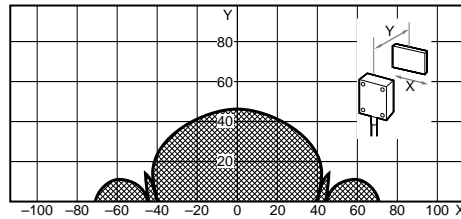

V600-D23P72 & V600-H07

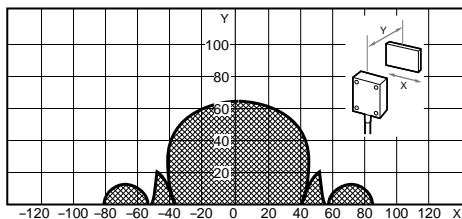

V600-D23P72 & V600-H11

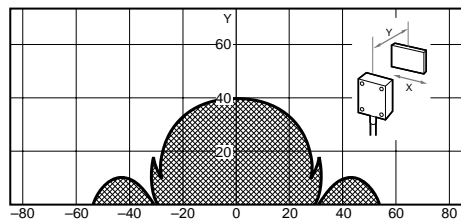

V600-D23P66N & V600-H07

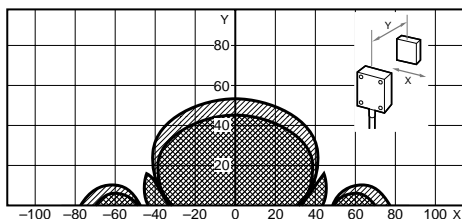

V600-D23P66N & V600-H11

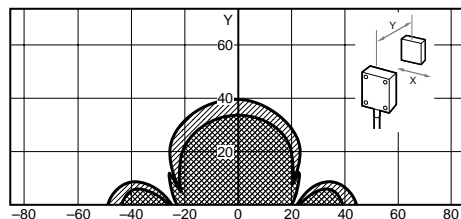

V600-D23P66SP & V600-H07

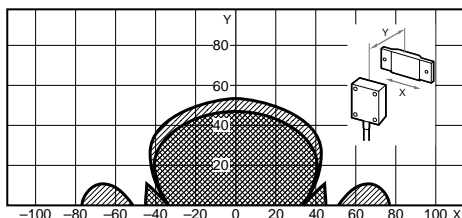

V600-D23P66SP & V600-H11

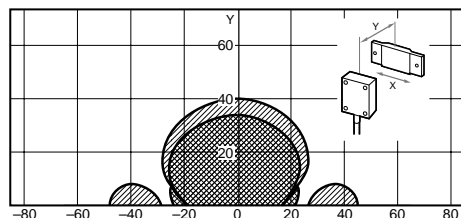

V600-D23P61 & V600-H11

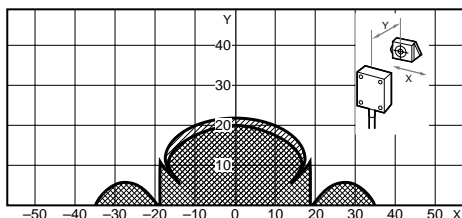

V600-D23P61 & V600-H51

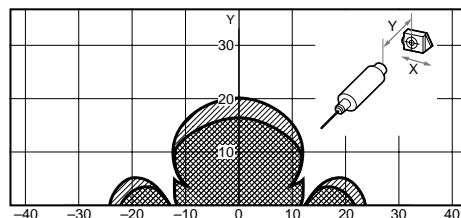

 Read range (in transmission distance priority mode)
  Write range (in transmission distance or transmission time priority mode)
  Read range (in transmission time priority mode)

**V600-D23P53 & V600-HS51
+V600-HA51**

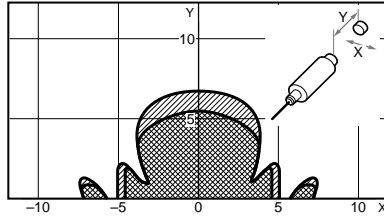

**V600-D23P53 & V600-HS61
+V600-HA51**

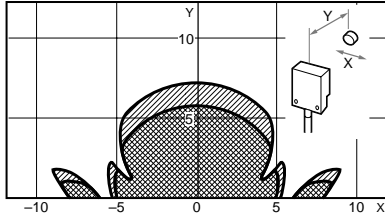

V600-D23P53 & V600-H52

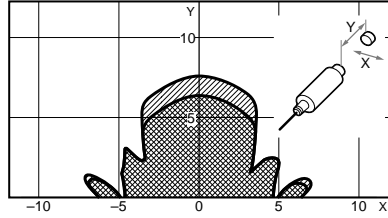

**V600-D23P54 & V600-HS51
+V600-HA51**

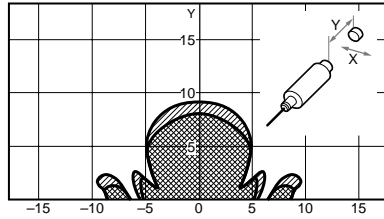

**V600-D23P54 & V600-HS61
+V600-HA51**

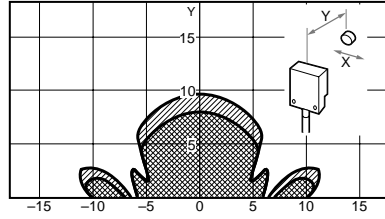

V600-D23P54 & V600-H52

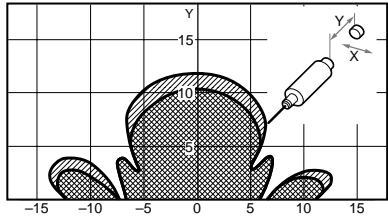

**V600-D23P55 & V600-HS51
+V600-HA51**

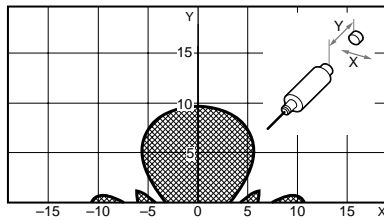

**V600-D23P55 & V600-HS61
+V600-HA51**

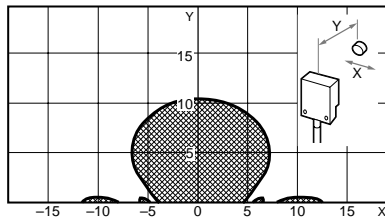

V600-D23P55 & V600-H52

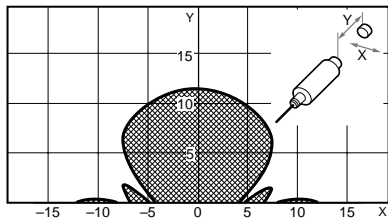

 Read range (in transmission distance priority mode)
  Write range (in transmission distance or transmission time priority mode)
 Read range (in transmission time priority mode)

Built-in-battery Data Carriers with Large Memory Capacity

V600-D8KR12 & V600-H07

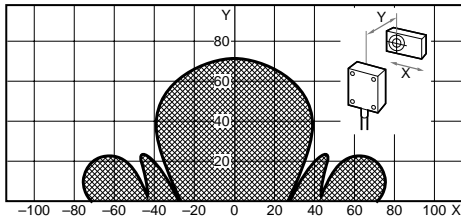

V600-D8KR12 & V600-H11

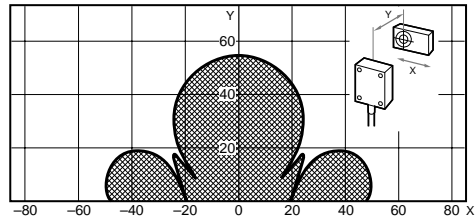

V600-D8KR13 & V600-H07

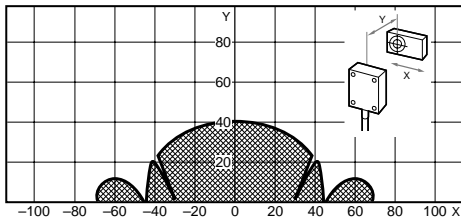

V600-D8KR13 & V600-H11

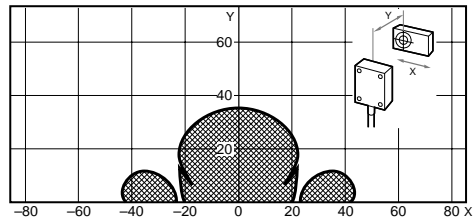

V600-D8KR04 & V600-H07

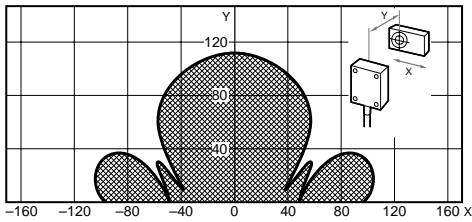

V600-D8KR04 & V600-H11

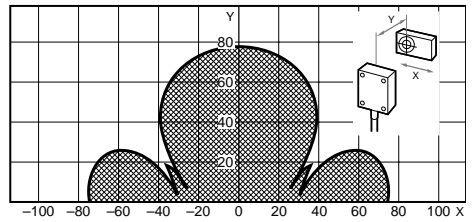

Battery-less Data Carriers with Large Memory Capacity

V600-D8KF04 & V600-H07

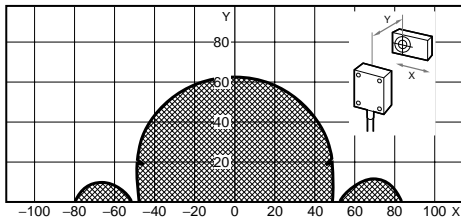

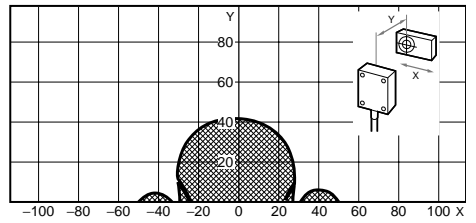

V600-D8KF04 & V600-H11

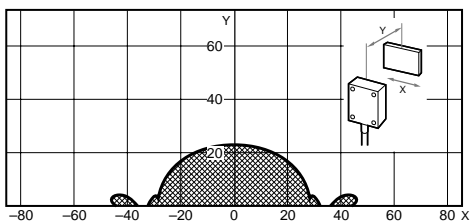

Replaceable-battery Data Carriers with Large Memory Capacity

V600-D2KR16 & V600-H11



 Read/Write range (in transmission distance or transmission time priority mode)

■ Communications Time

- The communications time does not depend on the model of R/W Head or Data Carrier, although communications times differ between Data Carriers with and without batteries.
- The turn around time (TAT) is the total time required from the issuance of a command from the host device (for example, a host computer) until the reception of a response.
- The lower-level communications time does not include the host communications; it is the time required for communications between the R/W Head and Data Carrier. The lower-level communications time is used in the equation for the DC speed.

$$DC \text{ Speed} = (\text{Distance travelled in the transmission range}) / (\text{Lower-level communications time})$$

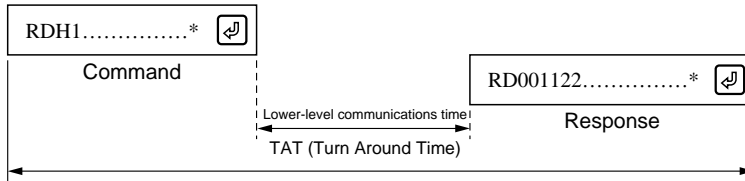

Lower-level Communications Time with Built-in-battery Data Carriers (Reference)

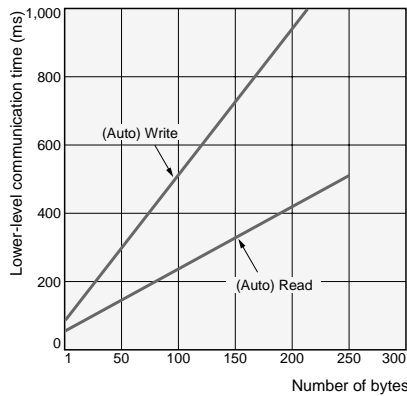

Calculation (Reference)

	Lower-level communications time (ms)
READ	$t = 1.8 N + 48.4$
WRITE	$t = 4.2 N + 86.5$

N is the number of processing bytes.

V600-D8KF04 (Battery-less)

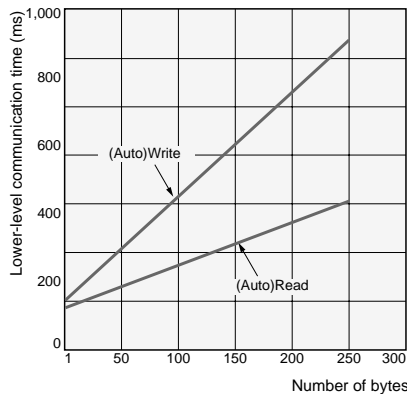

Calculation (Reference)

	Lower-level communications time (ms)
READ	$t = 1.8 N + 168.4$
WRITE	$t = 4.2 N + 206.5$

N is the number of processing bytes.

Lower-level Communications Time with Battery-less Data Carriers (Reference) (Battery-less Models Excluding V600-D8KF04)

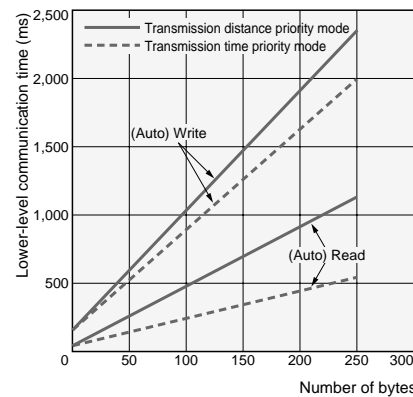

Calculation (Reference)

	R/W	Lower-level communications time (ms)
Distance priority mode	READ	$t = 4.3 N + 64.6$
	WRITE	$t = 8.7 N + 167.1$
Time priority mode	READ	$t = 1.8 N + 79.0$
	WRITE	$t = 7.1 N + 180.4$

N is the number of processing bytes.

Battery Life

The Data Carrier has a built-in lithium battery.

The following graphs show the relationship between the number of bytes per transmission, the number of transmissions per day, and the battery life.

V600-D8KR12 (Typical Example)

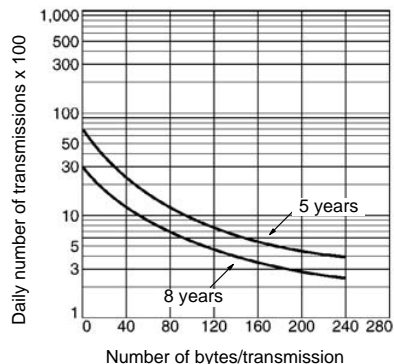

V600-D8KR04 (Typical Example)

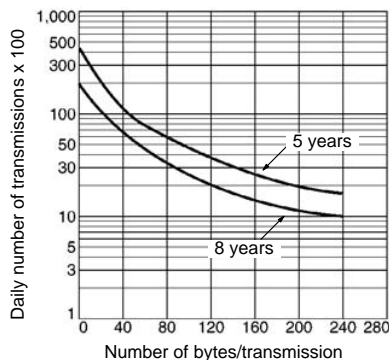

V600-D8KR13 (Typical Example)

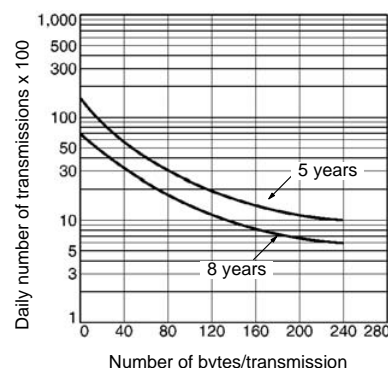

Temperature and Battery Life

V600-D2KR16

The battery life is two years at 25°C regardless of the relationship between the number of bytes read/written and the number of transmissions.

Examples Showing Relationship between Battery Life and Temperature

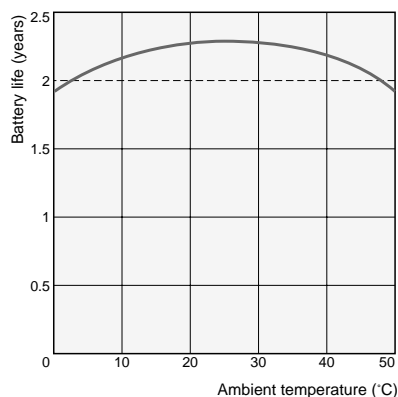

The following table shows the standard values.

Temperature	Battery consumption rate in one year
20°C	1%
30°C	2%
40°C	4%
50°C	8%
60°C	16%
70°C	32%

Note: If the battery is stored at 70°C and is not installed, the battery life is calculated as follows:

$$2 \text{ (years)} \times (1 - 0.32) = 1.36 \text{ years}$$

If the battery is stored at 25°C after one year's storage, the battery life will be approximately 1 year and 4 months. (The battery life will be shortened if the battery is used at temperatures close to 0°C or 50°C.)

The values in the above graph are based on the battery being installed (i.e., the insulation sheet is removed). If the battery is not installed, the values shown in the above table will apply.

Precautions

Data Carrier Batteries

Built-in-battery Data Carriers

⚠ WARNING

The SRAM-type Data Carrier has a built-in lithium battery which may occasionally ignite, explode, and burn if mishandled. Do not disassemble, deform, heat above 212°F (100°C), or incinerate the Data Carrier.



Replaceable-battery Data Carriers

⚠ WARNING

The SRAM-type Data Carrier has replaceable lithium batteries which may occasionally take fire, explode, burn, or leak liquid if mishandled. Do not deform, heat above 212°F (100°C), incinerate, or charge the batteries, or short-circuit their positive and negative terminals.



Mutual Interference (Reference Values)

Mutual Interference between R/W Heads

When more than one set of R/W Heads are used, mutual interference between the Heads can be avoided by mounting the Heads at the specified distance as shown below.

V600-H07

- Facing
RD/WT command: 650 mm min.
Auto command: 900 mm min.

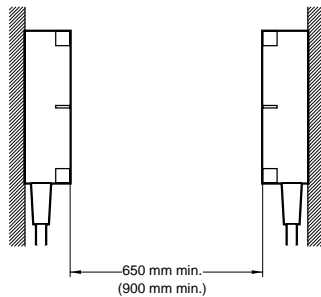

- Side-by-side
RD/WT command: 550 mm min.
Auto command: 1,200 mm min.

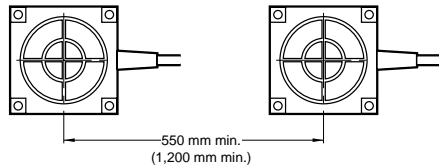

V600-H11

- Facing
RD/WT command: 200 mm min.
Auto command: 200 mm min.

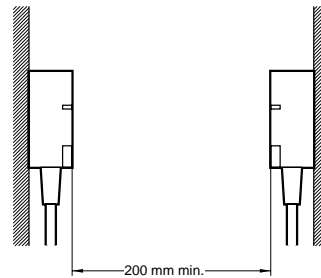

- Side-by-side
RD/WT command: 200 mm min.
Auto command: 200 mm min.

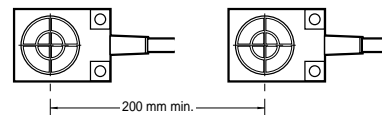

V600-H51

- Facing: 120 mm min.

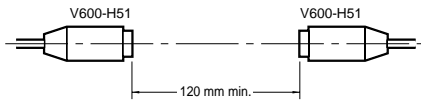

- Side-by-side: 100 mm min.

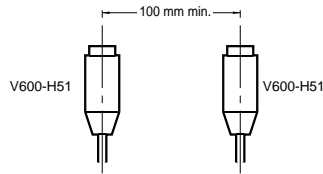

V600-H52

- Facing: 80 mm min.

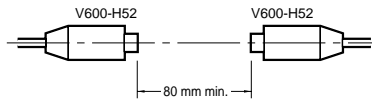

- Side-by-side: 80 mm min.

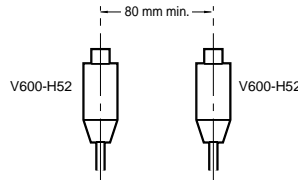

V600-HS51

- Facing: 80 mm min.

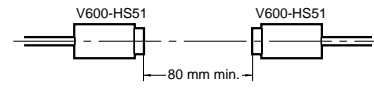

- Side-by-side: 80 mm min.

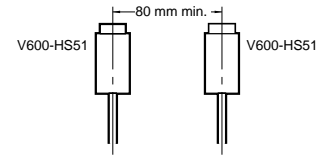

V600-HS61

- Facing: 80 mm min.

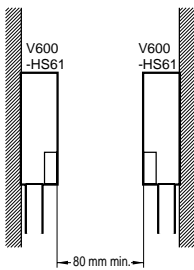

- Side-by-side: 80 mm min.

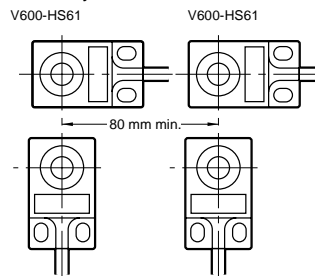

Note: If the two R/W Heads are not transmitting simultaneously (i.e., independent read/write), mutual interference will not occur. Therefore, the restriction on the distance between the Heads will not be applicable. The commands will be received by the R/W Heads and transmission will oscillate between them.

Mutual Interference between Proximity Sensors

The V600-series Units use electromagnetic coupling (frequency: 530 kHz). When a V600 Unit is wired close to R/W Heads, Proximity Switches, and Sensors that have an oscillating frequency between 400 and 600 kHz, the Proximity Sensor may malfunction, so be sure to install the Units according to the distance restrictions specified in the following diagrams. Make sure to thoroughly test that the mounting positions and the fixed positions of the Sensors are correct before putting them into actual operation.

V600-H07

- Vertical/Parallel: 400 mm min.

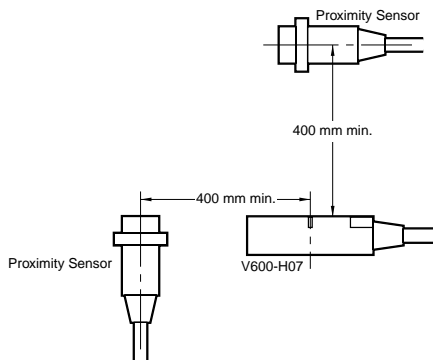

- Facing: 300 mm min.

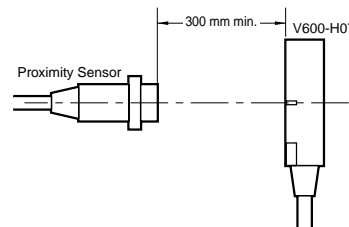

V600-H11

- Vertical/Parallel: 100 mm min.

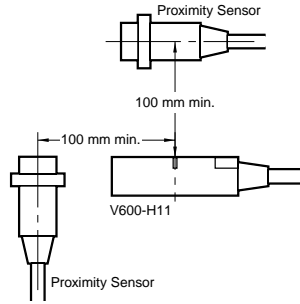

- Facing: 100 mm min.

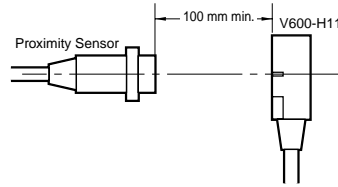

V600-H51/H52

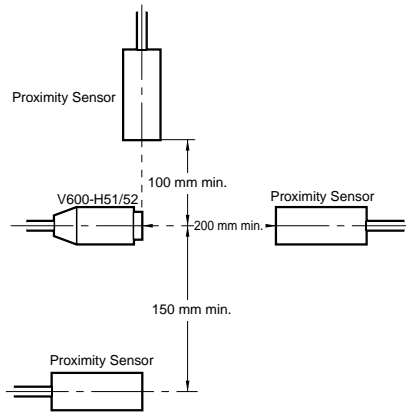

V600-HS51

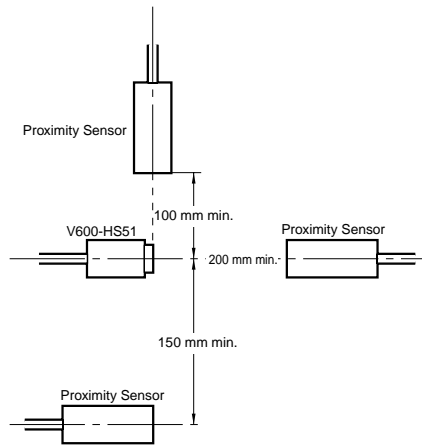

V600-HS61

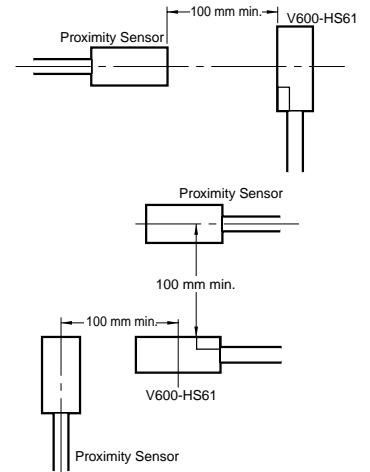

Mutual Interference between Data Carriers

When more than one Data Carrier is used, mutual interference between the DCs can be avoided by making sure that they are mounted apart at the distances specified below.

Reading/Writing

V600-D23P53

R/W Head: V600-H52, V600-HS51 + V600-HA51, V600-HS61 + V600-HA51

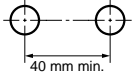

V600-D23P54

R/W Head: V600-H52, V600-HS51 + V600-HA51, V600-HS61 + V600-HA51

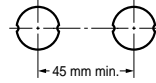

V600-D23P55

R/W Head: V600-H52, V600-HS51 + V600-HA51, V600-HS61 + V600-HA51

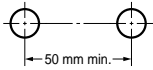

V600-D23P61

R/W Head: V600-H11/H51

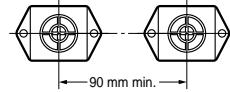

V600-D23P66N

R/W Head: V600-H11

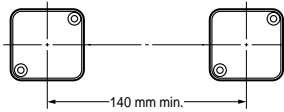

V600-D23P66SP

R/W Head: V600-H11

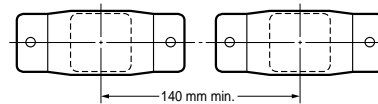

R/W Head: V600-H07

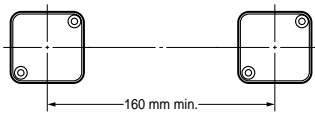

R/W Head: 600-H07

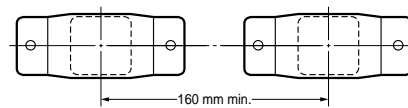

V600-D23P72

R/W Head: V600-H11

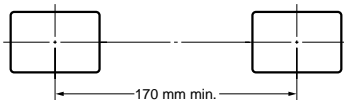

R/W Head: V600-H07

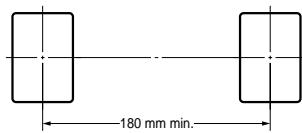
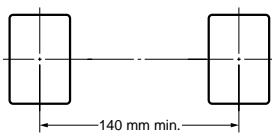
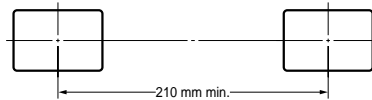

V600-D23P71

R/W Head: V600-H07

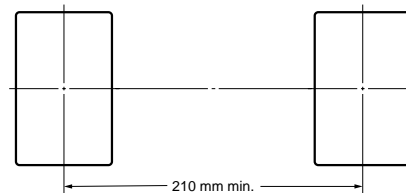
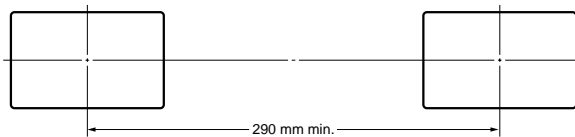

V600-D8KR12

R/W Head: V600-H11

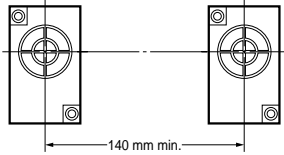
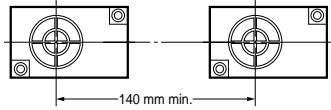

R/W Head: V600-H07

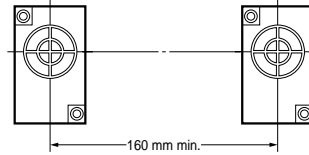
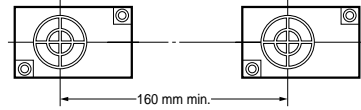

V600-D8KR13

R/W Head: V600-H11

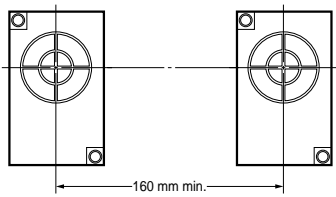
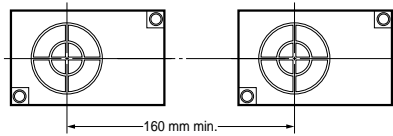

R/W Head: V600-H07

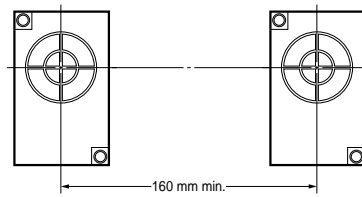
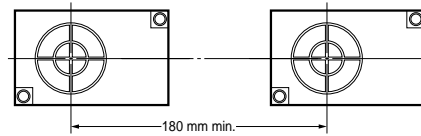

V600-D8KR04/V600-D8KF04

R/W Head: V600-H11

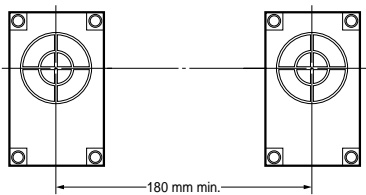
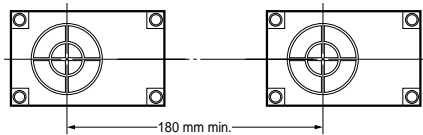

R/W Head: V600-H07

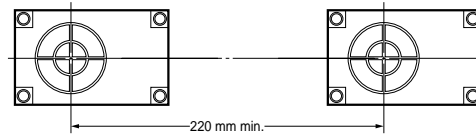

V600-D2KR16

R/W Head: V600-H11

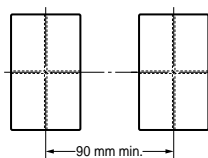
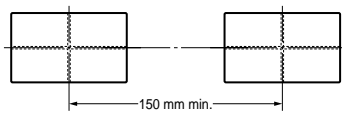

Dimensions

Note: All units are in millimeters unless otherwise indicated.

Data Carriers with Large Memory Capacity

Built-in-battery DCs

V600-D8KR12

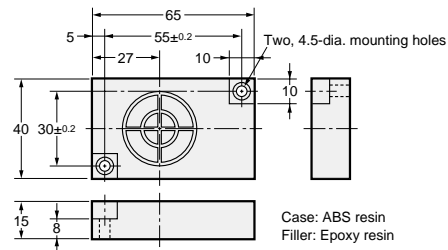

V600-D8KR13

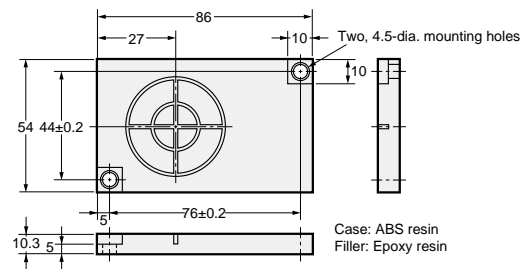

V600-D8KR04

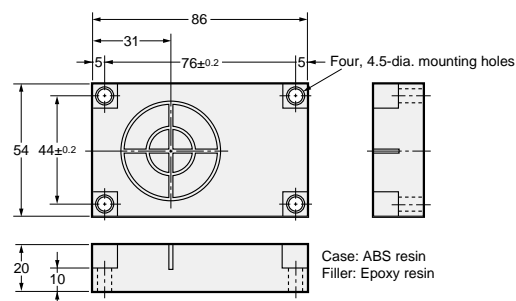

Replaceable-battery DCs

V600-D2KR16

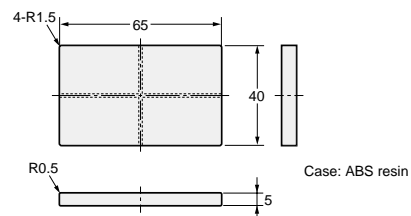

Battery-less DCs

V600-D8KF04

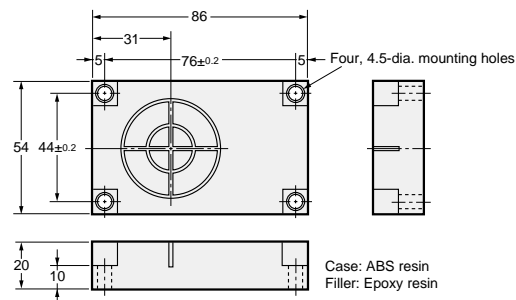

Data Carriers with Small Memory Capacity

Battery-less DCs

V600-D23P53

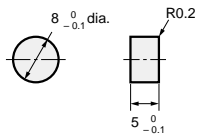

Case: ABS resin
Filler: Epoxy resin

V600-D23P54

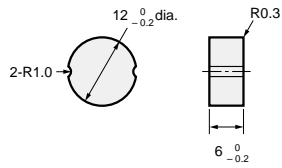

Case: ABS resin
Filler: Epoxy resin

V600-D23P55

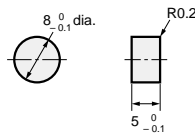

Case: PPS resin
Filler: Epoxy resin

V600-D23P61

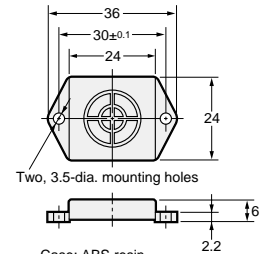

Case: ABS resin
Filler: Epoxy resin

V600-D23P66N

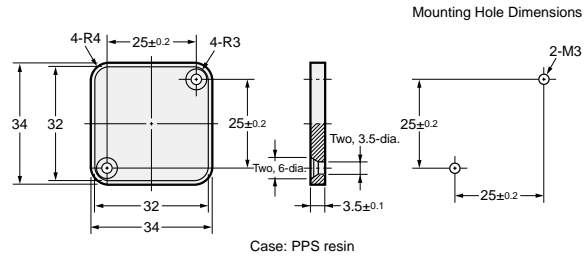

Case: PPS resin

V600-D23P66SP

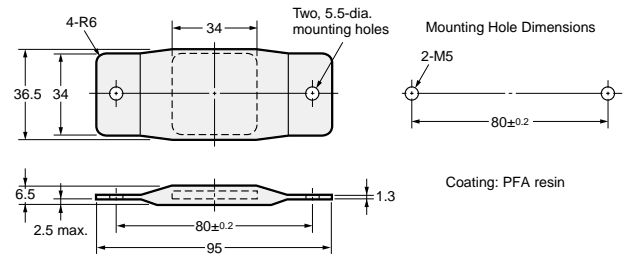

Coating: PFA resin

V600-D23P71

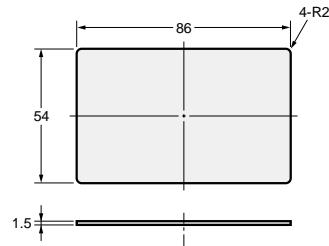

Case: Glass epoxy resin
Coating: Polyurethane resin

V600-D23P72

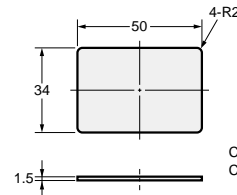

Case: Glass epoxy resin
Coating: Polyurethane resin

R/W Heads

V600-H07

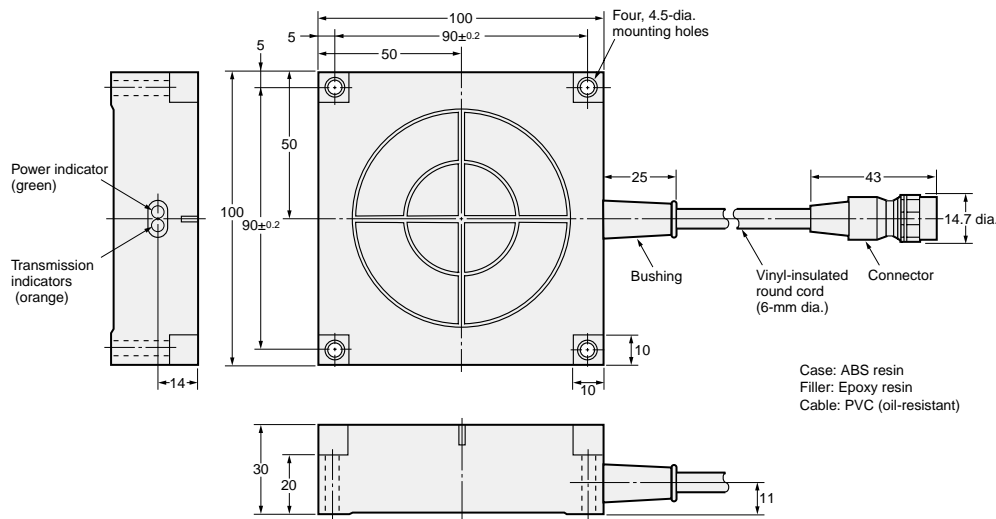

V600-H11

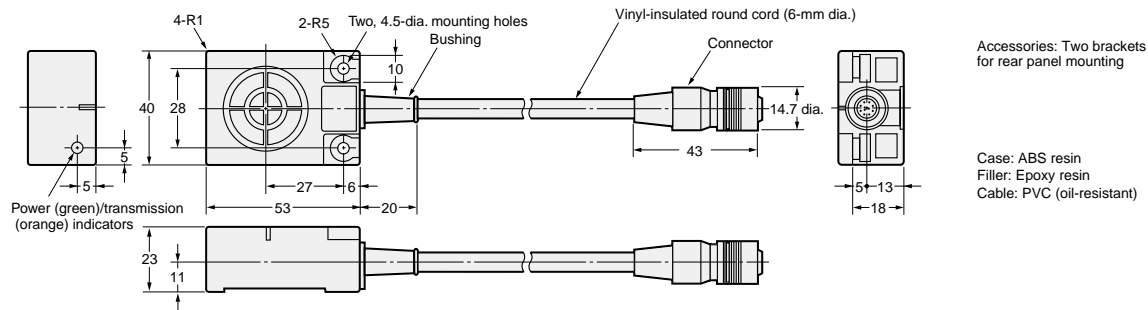

V600-H51

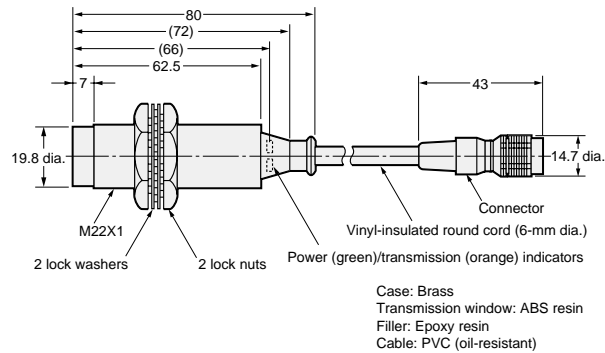

V600-H52

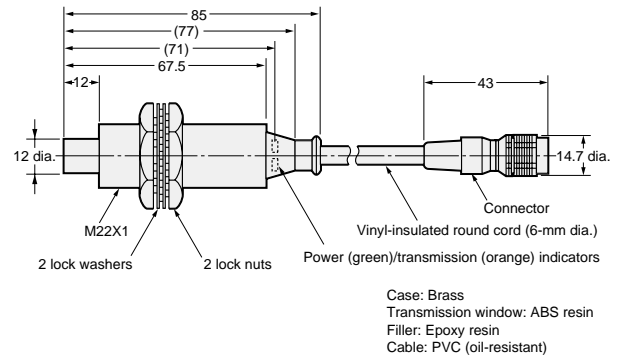

V600-HS51 (Sensor Section)

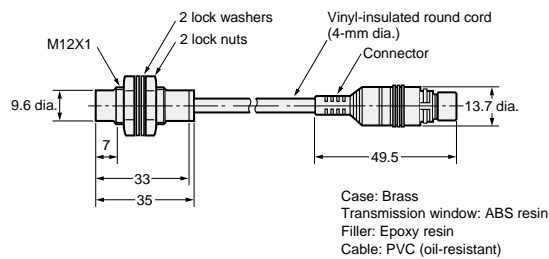

V600-HS61 (Sensor Section)

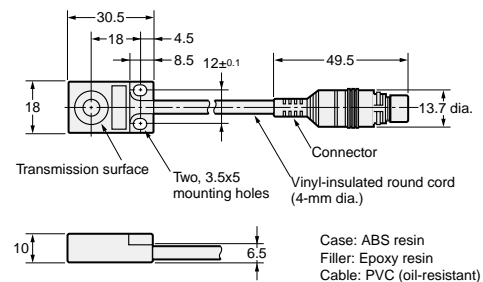

V600-HA51 (Amplifier Section)

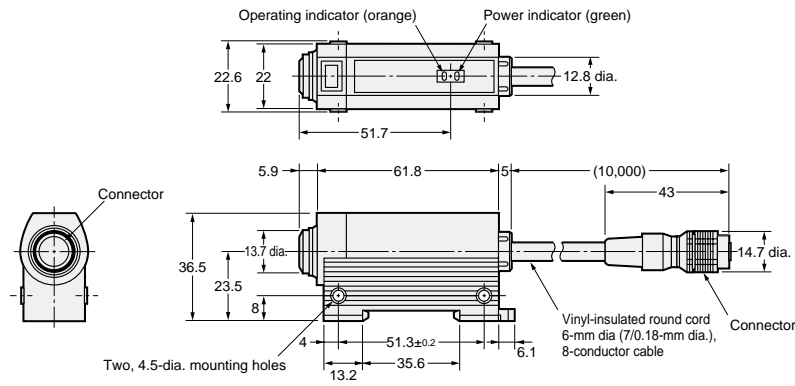

Case: ABS resin
Filler: Epoxy resin
Cable: PVC (oil-resistant)

ID Controllers

V600-CA5D02 (Compact)

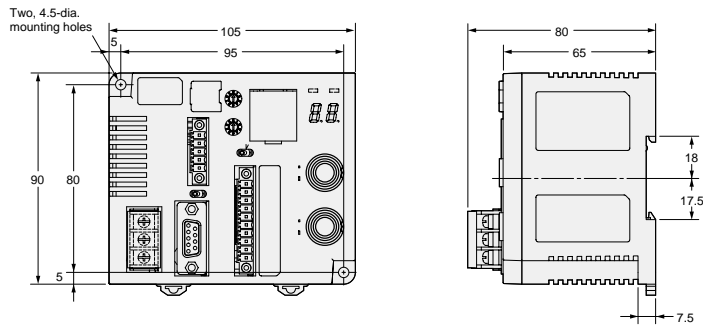

V600-CD1D-V3 (Compact)

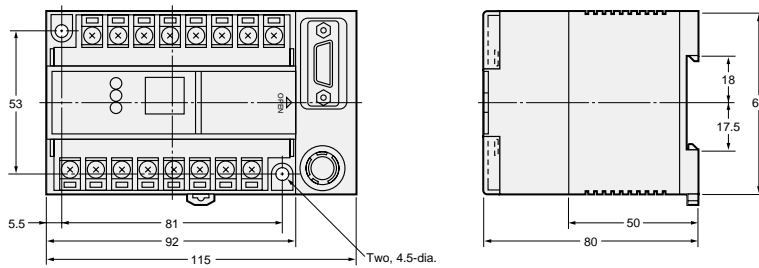

V600-CM1D (Board-mounted)

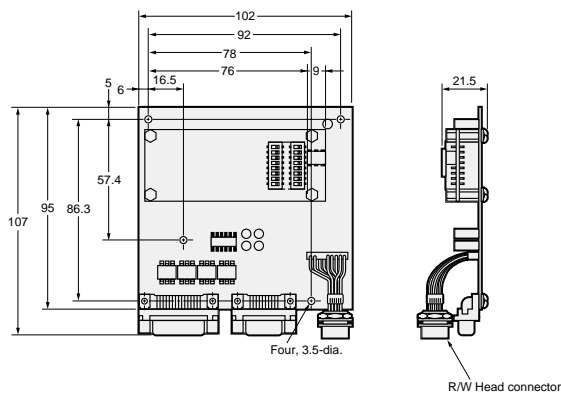

■ Accessories

Holder

V600-A81

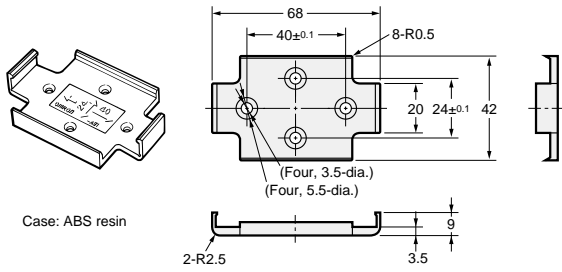

V600-A84

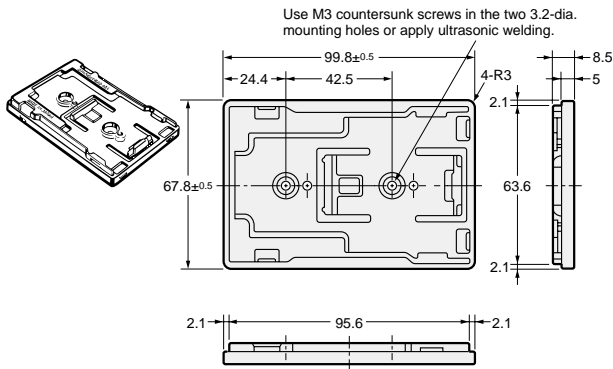

Attachment

V600-A86

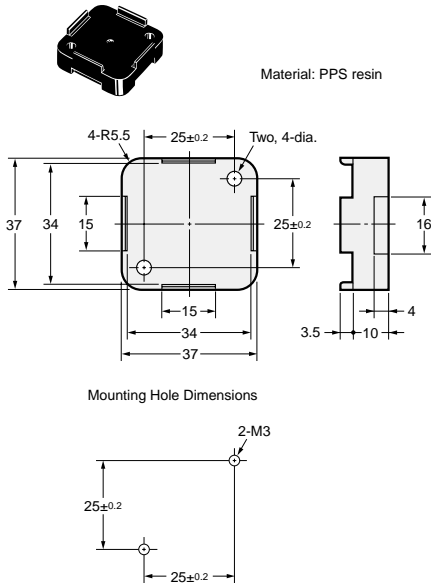

ALL DIMENSIONS SHOWN ARE IN MILLIMETERS.
To convert millimeters into inches, multiply by 0.03937. To convert grams into ounces, multiply by 0.03527.

READ AND UNDERSTAND THIS DOCUMENT

Please read and understand this document before using the products. Please consult your OMRON representative if you have any questions or comments.

WARRANTY

OMRON's exclusive warranty is that the products are free from defects in materials and workmanship for a period of one year (or other period if specified) from date of sale by OMRON.

OMRON MAKES NO WARRANTY OR REPRESENTATION, EXPRESS OR IMPLIED, REGARDING NON-INFRINGEMENT, MERCHANTABILITY, OR FITNESS FOR PARTICULAR PURPOSE OF THE PRODUCTS. ANY BUYER OR USER ACKNOWLEDGES THAT THE BUYER OR USER ALONE HAS DETERMINED THAT THE PRODUCTS WILL SUITABLY MEET THE REQUIREMENTS OF THEIR INTENDED USE. OMRON DISCLAIMS ALL OTHER WARRANTIES, EXPRESS OR IMPLIED.

LIMITATIONS OF LIABILITY

OMRON SHALL NOT BE RESPONSIBLE FOR SPECIAL, INDIRECT, OR CONSEQUENTIAL DAMAGES, LOSS OF PROFITS OR COMMERCIAL LOSS IN ANY WAY CONNECTED WITH THE PRODUCTS, WHETHER SUCH CLAIM IS BASED ON CONTRACT, WARRANTY, NEGLIGENCE, OR STRICT LIABILITY.

In no event shall responsibility of OMRON for any act exceed the individual price of the product on which liability is asserted.

IN NO EVENT SHALL OMRON BE RESPONSIBLE FOR WARRANTY, REPAIR, OR OTHER CLAIMS REGARDING THE PRODUCTS UNLESS OMRON'S ANALYSIS CONFIRMS THAT THE PRODUCTS WERE PROPERLY HANDLED, STORED, INSTALLED, AND MAINTAINED AND NOT SUBJECT TO CONTAMINATION, ABUSE, MISUSE, OR INAPPROPRIATE MODIFICATION OR REPAIR.

SUITABILITY FOR USE

THE PRODUCTS CONTAINED IN THIS DOCUMENT ARE NOT SAFETY RATED. THEY ARE NOT DESIGNED OR RATED FOR ENSURING SAFETY OF PERSONS, AND SHOULD NOT BE RELIED UPON AS A SAFETY COMPONENT OR PROTECTIVE DEVICE FOR SUCH PURPOSES. Please refer to separate catalogs for OMRON's safety rated products.

OMRON shall not be responsible for conformity with any standards, codes, or regulations that apply to the combination of products in the customer's application or use of the product.

At the customer's request, OMRON will provide applicable third party certification documents identifying ratings and limitations of use that apply to the products. This information by itself is not sufficient for a complete determination of the suitability of the products in combination with the end product, machine, system, or other application or use.

The following are some examples of applications for which particular attention must be given. This is not intended to be an exhaustive list of all possible uses of the products, nor is it intended to imply that the uses listed may be suitable for the products:

- Outdoor use, uses involving potential chemical contamination or electrical interference, or conditions or uses not described in this document.
- Nuclear energy control systems, combustion systems, railroad systems, aviation systems, medical equipment, amusement machines, vehicles, safety equipment, and installations subject to separate industry or government regulations.
- Systems, machines, and equipment that could present a risk to life or property.

Please know and observe all prohibitions of use applicable to the products.

NEVER USE THE PRODUCTS FOR AN APPLICATION INVOLVING SERIOUS RISK TO LIFE OR PROPERTY WITHOUT ENSURING THAT THE SYSTEM AS A WHOLE HAS BEEN DESIGNED TO ADDRESS THE RISKS, AND THAT THE OMRON PRODUCT IS PROPERLY RATED AND INSTALLED FOR THE INTENDED USE WITHIN THE OVERALL EQUIPMENT OR SYSTEM.

PERFORMANCE DATA

Performance data given in this document is provided as a guide for the user in determining suitability and does not constitute a warranty. It may represent the result of OMRON's test conditions, and the users must correlate it to actual application requirements. Actual performance is subject to the OMRON Warranty and Limitations of Liability.

CHANGE IN SPECIFICATIONS

Product specifications and accessories may be changed at any time based on improvements and other reasons.

It is our practice to change model numbers when published ratings or features are changed, or when significant construction changes are made. However, some specifications of the product may be changed without any notice. When in doubt, special model numbers may be assigned to fix or establish key specifications for your application on your request. Please consult with your OMRON representative at any time to confirm actual specifications of purchased products.

DIMENSIONS AND WEIGHTS

Dimensions and weights are nominal and are not to be used for manufacturing purposes, even when tolerances are shown.

ERRORS AND OMISSIONS

The information in this document has been carefully checked and is believed to be accurate; however, no responsibility is assumed for clerical, typographical, or proofreading errors, or omissions.

PROGRAMMABLE PRODUCTS

OMRON shall not be responsible for the user's programming of a programmable product, or any consequence thereof.

COPYRIGHT AND COPY PERMISSION

This document shall not be copied for sales or promotions without permission.

This document is protected by copyright and is intended solely for use in conjunction with the product. Please notify us before copying or reproducing this document in any manner, for any other purpose. If copying or transmitting this document to another, please copy or transmit it in its entirety.

