

SML1206-5VY4-TR

Yellow

Surface Mount LED

3.2 × 1.6 × 1.1 mm Chip LED

120° viewing angle

DWG BY:
BL / GP
12-03-07

CHK BY:
PL
12-03-07

QA:
—
— — —

MFG:
—
— — —

REVISION LTR: -
12-03-07

● **Features:**

1. Emitted Color : Yellow.
2. Lens Appearance : Water Clear
3. Mono-color type.
4. 3.2x1.6x1.1mm(1206)standard package
5. Suitable for all SMT assembly methods.
6. Compatible with infrared and vapor phase reflow solder process.
7. Compatible with automatic placement equipment.
8. For DC and pulse operation With current limiting resistor for 05V TTL & CMOS compatible.
10. This product doesn't contain restriction Substance, comply ROHS standard.

● **Applications:**

1. Automotive : Dashboards, stop lamps, turn signals.
2. Backlighting : LCDs, Key pads advertising.
3. Status indicators : Comsumer & industrial electronics.
4. General use.

● **Absolute Maximum Ratings(Ta=25℃)**

Parameter	Symbol	Rating	Unit
Operating Voltage MXA	V _F	5	V
Operating Temperature	Topr	-25℃~80℃	-
Storage Temperature	Tstg	-30℃~85℃	-
Soldering Temperature	Tsol	See Page 5	-

* 1 Condition for IFp is pulse of 1/10 duty and 0.1msec width.

● **Package Dimensions:**

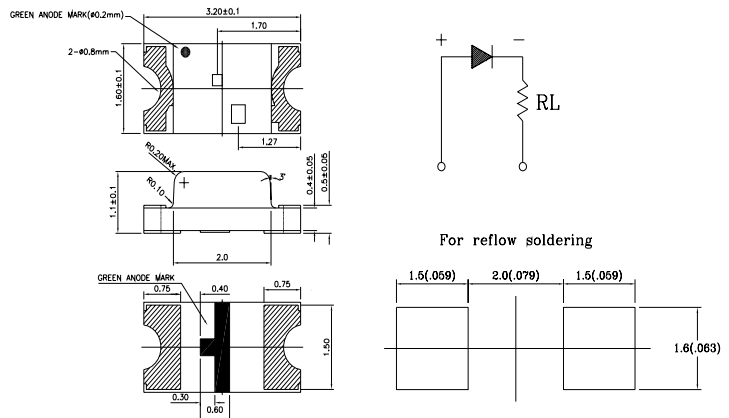

NOTES:

1. All dimensions are in millimeters (inches).
2. Tolerance is ± 0.10mm (0.004") unless otherwise specified.
3. Specifications are subject to change without notice.

● **Electrical and optical characteristics(Ta=25°C)**

Parameter	Symbol	Condition	Min.	Typ.	Max.	Unit
Forward Current	V_f	$V=5V$	-	12.8	-	mA
Luminous Intensity	I_v	$V_f=5V$	2.4	5.0	-	mcd
Peak Wave Length	λ_p	$V_f=5V$	-	585	-	nm
Dominant Wave Length	λ_d	$V_f=5V$	-	587	-	nm
Spectral Line Half-width	$\Delta \lambda$	$V_f=5V$	-	36	-	nm
Viewing Angle	$2\theta_{1/2}$	$I_f=20mA$	-	120	-	deg
Radiant Intensity		$I_f=20mA$	-	-	-	$\mu W/sr$
Chromaticity Coordinates	X	$I_f=20mA$	-	0.55	-	
	Y		-	0.44	-	

● **Typical Electro-Optical Characteristics Curves**

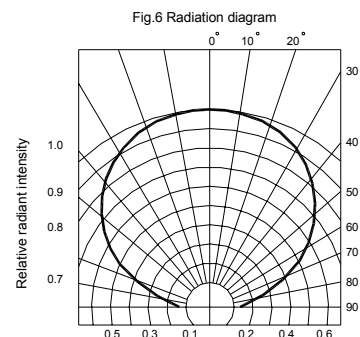
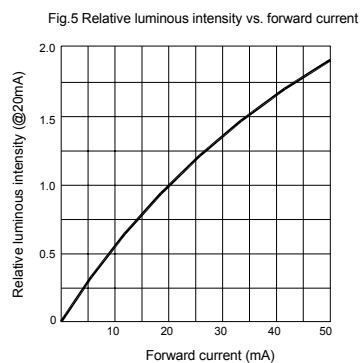
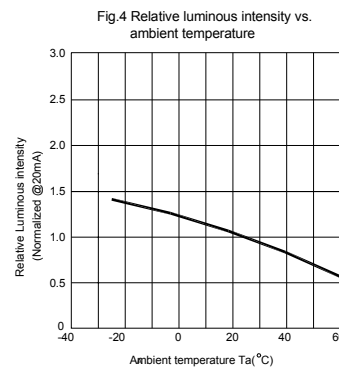
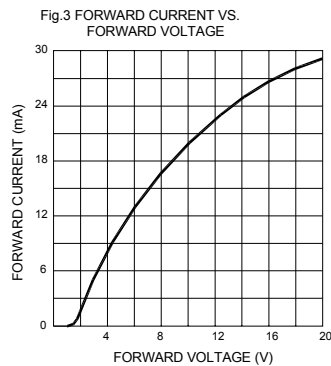
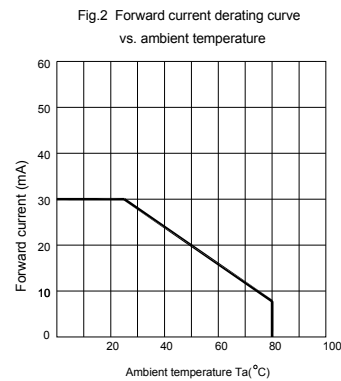
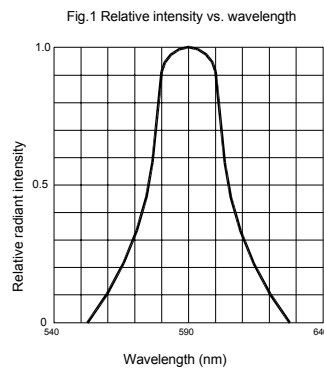

● **Tapping and packaging specifications(Units: mm)**

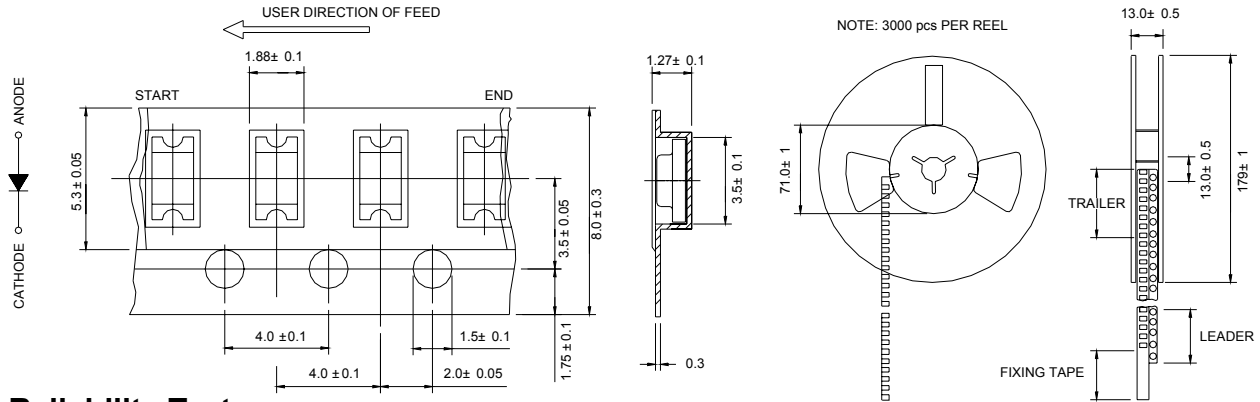

● **Reliability Test**

Classification	Test Item	Reference Standard	Test Conditions	Result
Endurance Test	Operation Life	MIL-STD-750:1026 MIL-STD-883:1005 JIS-C-7021 :B-1	Connect with a power $I_f=20\text{mA}$ T_a =Under room temperature Test time=1,000hrs	0/20
	High Temperature High Humidity Storage	MIL-STD-202:103B JIS-C-7021 :B-11	$T_a=+65^\circ\text{C} \pm 5^\circ\text{C}$ RH=90%-95% Test time=240hrs	0/20
	High Temperature Storage	MIL-STD-883:1008 JIS-C-7021 :B-10	High $T_a=+85^\circ\text{C} \pm 5^\circ\text{C}$ Test time=1,000hrs	0/20
	Low Temperature Storage	JIS-C-7021 :B-12	Low $T_a=-35^\circ\text{C} \pm 5^\circ\text{C}$ Test time=1,000hrs	0/20
Environmental Test	Temperature Cycling	MIL-STD-202:107D MIL-STD-750:1051 MIL-STD-883:1010 JIS-C-7021 :A-4	$-35^\circ\text{C} \sim +25^\circ\text{C} \sim +85^\circ\text{C} \sim +25^\circ\text{C}$ 60min 20min 60min 20min Test Time=5cycle	0/20
	Thermal Shock	MIL-STD-202:107D MIL-STD-750:1051 MIL-STD-883:1011	$-35^\circ\text{C} \pm 5^\circ\text{C} \sim +85^\circ\text{C} \pm 5^\circ\text{C}$ 20min 20min Test Time=10cycle	0/20
	Solder Resistance	MIL-STD-202:201A MIL-STD-750:2031 JIS-C-7021 :A-1	Preheating : $140^\circ\text{C} \sim 160^\circ\text{C}$, within 2 minutes. Operation heating : 260°C (Max.), within 10seconds. (Max.)	0/20

● **Judgment criteria of failure for the reliability**

Measuring items	Symbol	Measuring conditions	Judgement criteria for failure
Forward voltage	V_F (V)	$I_F=20\text{mA}$	Over $U_x1.2$
Reverse current	I_R (μA)	$V_R=5\text{V}$	Over U_x2
Luminous intensity	I_v (mcd)	$I_F=20\text{mA}$	Below $SX0.5$

Note: 1.U means the upper limit of specified characteristics. S means initial value.
 2.Measurment shall be taken between 2 hours and after the test pieces have been returned to normal ambient conditions after completion of each test.

● **Soldering :**

1. Manual Of Soldering

The temperature of the iron tip should not be higher than 300°C(572°F) and Soldering within 3 seconds per solder-land is to be observed.

2. Reflow Soldering

Preheating : 140°C~160°C±5°C, within 2 minutes.
 Operation heating : 260°C (Max.) within 10 seconds.(Max)
 Gradual Cooling (Avoid quenching).

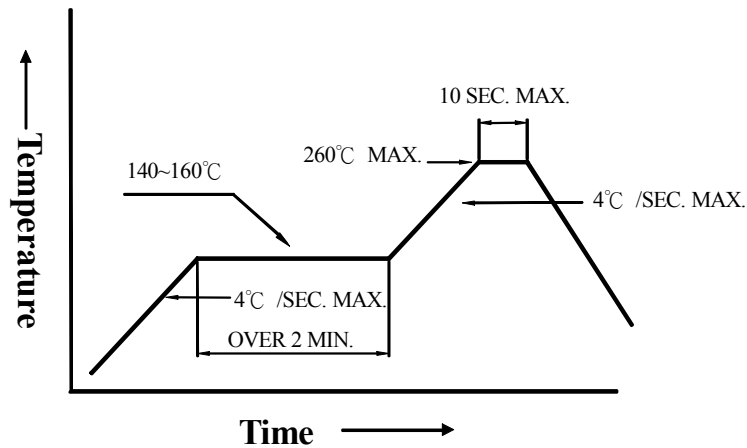

3. DIP soldering (Wave Soldering) :

Preheating : 120°C~150°C, within 120~180 sec.
 Operation heating : 245°C±5°C within 5 sec. 260°C (Max)
 Gradual Cooling (Avoid quenching).

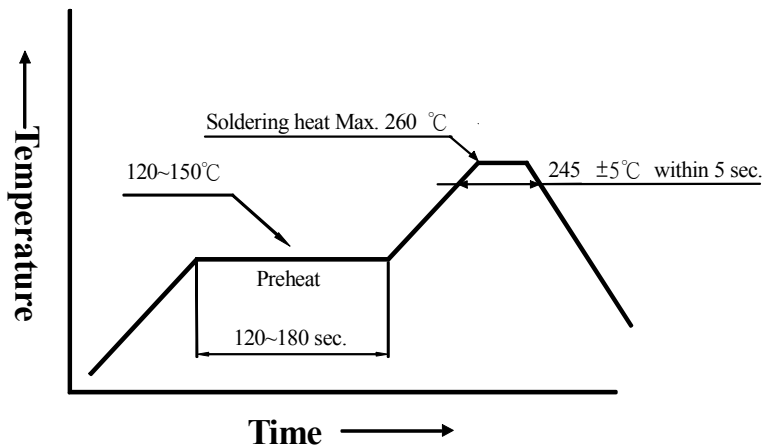

● **Handling :**

Care must be taken not to cause to the epoxy resin portion of LEDs while it is exposed to high temperature.

Care must be taken not rub the epoxy resin portion of LEDs with hard or sharp article such as the sand blast and the metal hook.