

SML0603-B1K-TR

Super Blue

0603 Profile Surface Mount LEDs

1.6×0.8×0.8mm

120° viewing angle

DWG BY:
BL / JG
11-08-06

CHK BY:
PL
11-17-06

QA:
—
— — —

MFG:
—
— — —

REVISION LTR: -
11-08-06

Features:

- 1.6x0.8x0.8mm(0603) standard package.
- Suitable for all SMT assembly methods.
- Compatible with infrared and vapor phase reflow solder processes.
- Compatible with automatic placement equipment.
- This product does not contain restricted substances, complies with ROHS standards.

Applications:

- Automotive : Dashboards, stop lamps, turn signals.
- Backlighting : LCDs, key pads, advertising.
- Status indicators : Consumer and industrial electronics.
- General use.

Package Dimensions:

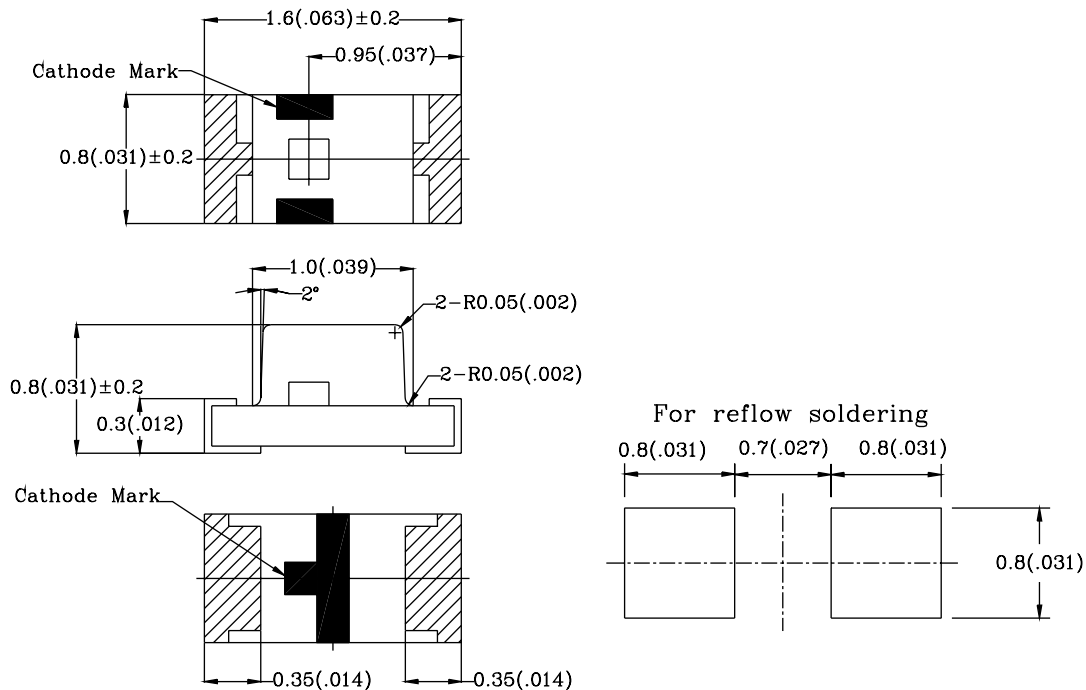

Part No.	Chip Material	Lens Color	Emission Color
SML0603-B1K-TR	InGaN	Water Clear	Super Pure Blue

Notes:

1. All dimensions are in millimeters (inches).
2. Tolerance is ± 0.10 mm (0.004") unless otherwise noted.
3. Specifications are subject to change without notice.

● **Electrical and optical characteristics (Ta=25°C)**

Parameter	Symbol	Condition	Min.	Typ.	Max.	Unit
Forward Voltage	V_F	$I_F=20mA$	-	3.0	4.0	V
Luminous Intensity	I_v	$I_F=20mA$	28	50	-	mcd
Peak Wave Length	λ_p	$I_F=20mA$	-	460	-	nm
Dominant Wave Length	λ_d	$I_F=20mA$	465	466	475	nm
Spectral Line Half-width	$\Delta\lambda$	$I_F=20mA$	-	37	-	nm
Viewing Angle*	$2\theta_{1/2}$	$I_F=20mA$	-	120	-	deg
Radiant Intensity	I_e	$I_F=20mA$	-	-	-	$\mu W/sr$
Chromaticity Coordinates	X	$I_F=20mA$	-	0.14	-	
	Y		-	0.06	-	

* Viewing angle is the Off-axis at which the luminous intensity is half the axial intensity.

● **Absolute Maximum Ratings (Ta=25°C)**

Reverse Voltage	V_R	5V
Reverse Current (VR=5V)	I_R	100 μA
Continuous Forward Current	I_f	30mA
Peak Forward Current 1/10 duty cycle, 0.1ms Pulse Width	I_{fp}	100mA
Power Dissipation	P_d	120mW
Operating Temperature Range	T_{opr}	-25°C ~ 80°C
Storage Temperature Range	T_{stg}	-30°C ~ 85°C
Lead Soldering Temperature	T_{sol}	see Solder Instruction page

● **Typical Electro-Optical Characteristics Curves**

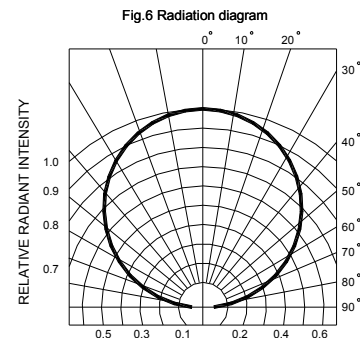
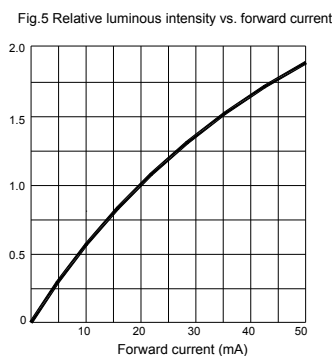
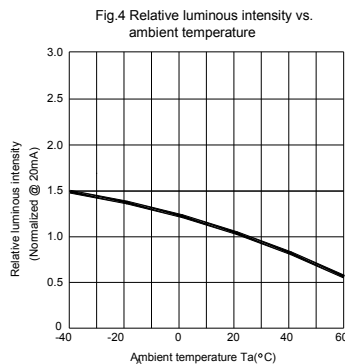
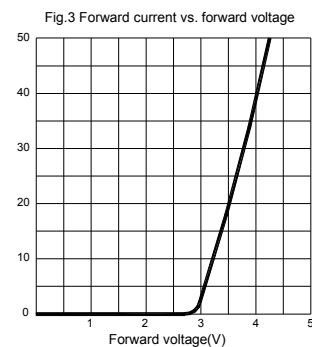
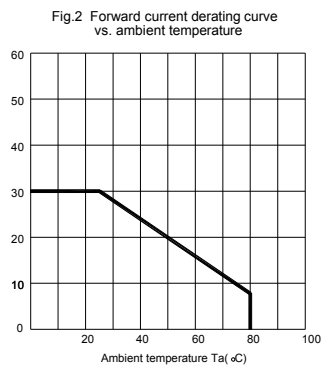
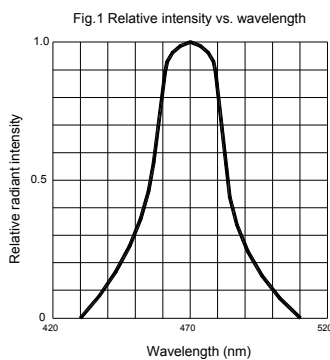

● **Tape and reel packaging specifications (Units: mm)**

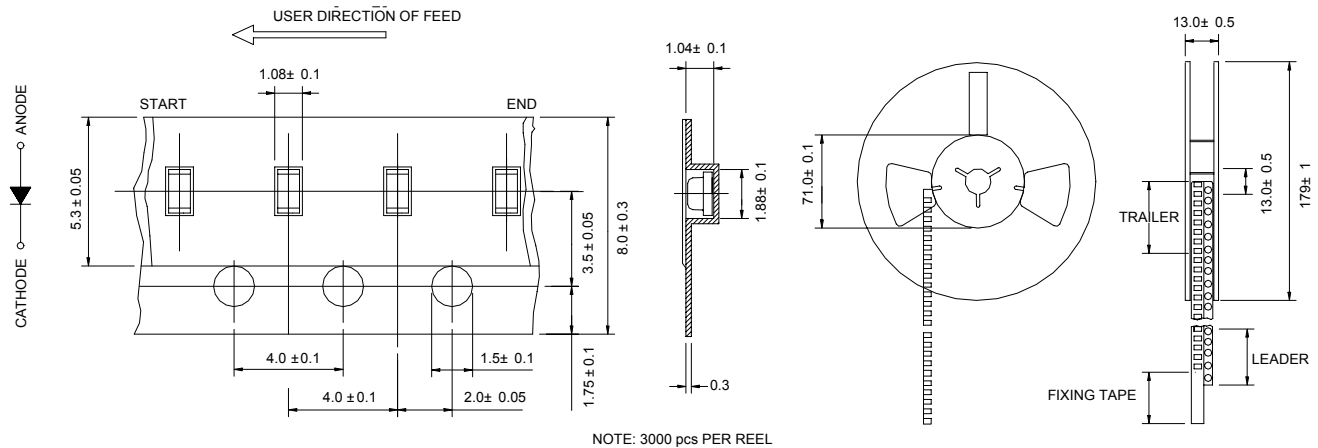

● **Bin Limits**

Intensity Bin Limits (At 20mA)

BIN CODE	Min. (mcd)	Max. (mcd)
M	24.0	48.0
N	36.0	72.0
P	55.0	110.0
Q	82.0	160.0

Color Bin Limits (At 20mA)

BIN CODE	Min. (nm)	Max. (nm)
4	464	471
5	469	476

V_F Bin Limits (At 20mA)

BIN CODE	Min.(v)	Max.(v)
J	3.15	3.45
K	3.35	3.65
L	3.55	3.85
M	3.75	4.05

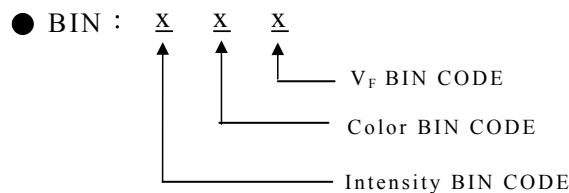

RELIABILITY TEST

Classification	Test Item	Reference Standard	Test Conditions	Result
Endurance Test	Operation Life	MIL-STD-750: 1026 MIL-STD-883: 1005 JIS C 7021: B-1	Connect with a power I = 20mA T _a = Under room temperature Test time = 1,000hrs	0/20
	High Temperature, High Humidity Storage	MIL-STD-202: 103B JIS C 7021: B-11	T _a = +65°C±5°C RH = 90%-95% Test time = 240hrs	0/20
	High Temperature Storage	MIL-STD-202: 1008 JIS C 7021: B-10	High T _a = +85°C±5°C Test time = 1,000hrs	0/20
	Low Temperature Storage	JIS C 7021: B-12	Low T _a = -35°C±5°C Test time = 1,000hrs	0/20
Environmental Test	Temperature Cycling	MIL-STD-202: 107D MIL-STD-750: 1051 MIL-STD-883: 1010 JIS C 7021: A-4	-35°C ~ +25°C ~ +85°C ~ +25°C 60min. 20min. 60min. 20min. Test time = 5 cycles	0/20
	Thermal Shock	MIL-STD-202: 107D MIL-STD-750: 1051 MIL-STD-883: 1011	-35°C±5°C ~ +85°C±5°C 20min. 20min. Test time = 10 cycles	0/20
	Solder Resistance	MIL-STD-202: 201A MIL-STD-750: 2031 JIS C 7021: A-1	Preheating: 140°C - 160°C, within 2 minutes. Operation heating: 235°C (Max.), within 10 seconds. (Max.)	0/20

JUDGEMENT CRITERIA OF FAILURE FOR THE RELIABILITY TEST

Measuring items	Symbol	Measuring conditions	Judgment criteria for failure
Forward voltage	V _f (V)	I _f = 20mA	Over Ux1.2
Reverse current	I _r (uA)	V _r = 5V	Over Ux2
Luminous intensity	I _v (mcd)	I _f = 20mA	Below Sx0.5

Note: 1. U means the upper limit of specific characteristics. S means initial value.
 2. Measurement shall be taken between 2 hours and after the test pieces have been returned to normal ambient conditions after completion of each test.

1. Soldering
Manual of Soldering

The temperature of the iron tip should not be higher than 300°C (572°F) and soldering within 3 seconds per solder-land is to be observed.

Reflow Soldering
 Preheating: 140°C~160°C ±5°C, within 2 minutes.
 Operation heating: 260°C (Max.) within 10 seconds. (Max.)
 Gradual Cooling (Avoid quenching).

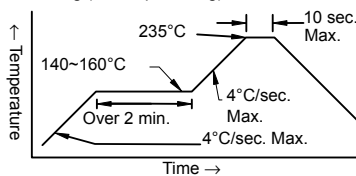

DIP Soldering (Wave Soldering)
 Preheating: 120°C~150°C, within 120~180 sec.
 Operation heating: 245°C ±5°C within 5 sec.
 260°C (Max.)
 Gradual Cooling (Avoid quenching).

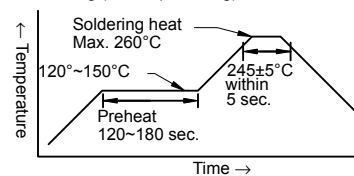

2. Handling

Care must be taken not to cause damage to the epoxy resin portion of LEDs while it is exposed to high temperatures, or abrade the epoxy resin portion of LEDs with hard or sharp items as from sand blasting and the use of sharp metallic objects.

3. Notes for designing

Care must be taken to provide the current limiting resistor in the circuit so as to drive the LEDs within the rated figures. Also, caution should be taken not to overload LEDs with instantaneous voltage at the turning ON and OFF of the circuit. When using the pulse drive care must be taken to keep the average current within the rated figures. Also, the circuit should be designed so as to be subjected to reverse voltage when turning off the LEDs.

4. Storage:

In order to avoid the absorption of moisture, it is recommended to solder LEDs as soon as possible after unpacking the sealed envelope. If the envelope is still packed, store it in the following environment:

- (1) Temperature: 5°C-30°C (41°F-86°F) Humidity: RH 60% Max.
- (2) After this bag is opened, devices that will be applied to infrared reflow, vapor-phase reflow, or equivalent soldering process must be:
 - a. Completed within 24 hours.
 - b. Stored at less than 30% RH
- (3) Devices require baking before mounting if: (2)a or (2)b is not met.
- (4) If baking is required, devices must be baked under below conditions:
 12 hours at 60°C ±3°C