

# RF Power Field Effect Transistors

## N-Channel Enhancement-Mode Lateral MOSFETs

Designed for W-CDMA base station applications with frequencies from 2110 to 2170 MHz. Suitable for TDMA, CDMA and multicarrier amplifier applications. To be used in Class AB for PCN-PCS/cellular radio, WLL and TD-SCDMA applications.

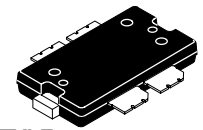
- Typical 2-Carrier W-CDMA Performance:  $V_{DD} = 28$  Volts,  $I_{DQ} = 1050$  mA,  $P_{out} = 23$  Watts Avg., Full Frequency Band, Channel Bandwidth = 3.84 MHz, PAR = 8.5 dB @ 0.01% Probability on CCDF.  
Power Gain — 14.5 dB  
Drain Efficiency — 25.5%  
IM3 @ 10 MHz Offset — -37 dBc in 3.84 MHz Bandwidth  
ACPR @ 5 MHz Offset — -40 dBc in 3.84 MHz Bandwidth
- Capable of Handling 5:1 VSWR, @ 28 Vdc, 2140 MHz, 100 Watts CW Output Power

### Features

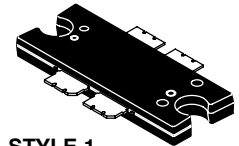
- Characterized with Series Equivalent Large-Signal Impedance Parameters
- Internally Matched for Ease of Use
- Qualified Up to a Maximum of 32  $V_{DD}$  Operation
- Integrated ESD Protection
- Designed for Lower Memory Effects and Wide Instantaneous Bandwidth Applications
- 200°C Capable Plastic Package
- N Suffix Indicates Lead-Free Terminations. RoHS Compliant.
- In Tape and Reel. R1 Suffix = 500 Units per 44 mm, 13 inch Reel.

**MRF6S21100NR1**  
**MRF6S21100NBR1**

**2110-2170 MHz, 23 W AVG., 28 V**  
**2 x W-CDMA**  
**LATERAL N-CHANNEL**  
**RF POWER MOSFETs**



**CASE 1486-03, STYLE 1**  
**TO-270 WB-4**  
**PLASTIC**  
**MRF6S21100NR1**



**CASE 1484-04, STYLE 1**  
**TO-272 WB-4**  
**PLASTIC**  
**MRF6S21100NBR1**

**Table 1. Maximum Ratings**

Rating	Symbol	Value	Unit
Drain-Source Voltage	$V_{DSS}$	-0.5, +68	Vdc
Gate-Source Voltage	$V_{GS}$	-0.5, +12	Vdc
Storage Temperature Range	$T_{stg}$	-65 to +175	°C
Operating Junction Temperature	$T_J$	200	°C

**Table 2. Thermal Characteristics**

Characteristic	Symbol	Value (1,2)	Unit
Thermal Resistance, Junction to Case Case Temperature 80°C, 100 W CW Case Temperature 73°C, 23 W CW	$R_{\theta JC}$	0.57 0.66	°C/W

1. MTTF calculator available at <http://www.freescale.com/rtf>. Select Tools/Software/Application Software/Calculators to access the MTTF calculators by product.
2. Refer to AN1955, *Thermal Measurement Methodology of RF Power Amplifiers*. Go to <http://www.freescale.com/rtf>. Select Documentation/Application Notes - AN1955.

**Table 3. ESD Protection Characteristics**

Test Methodology	Class
Human Body Model (per JESD22-A114)	1B (Minimum)
Machine Model (per EIA/JESD22-A115)	A (Minimum)
Charge Device Model (per JESD22-C101)	IV (Minimum)

**Table 4. Moisture Sensitivity Level**

Test Methodology	Rating	Package Peak Temperature	Unit
Per JESD 22-A113, IPC/JEDEC J-STD-020	3	260	°C

**Table 5. Electrical Characteristics** ( $T_C = 25^\circ\text{C}$  unless otherwise noted)

Characteristic	Symbol	Min	Typ	Max	Unit
----------------	--------	-----	-----	-----	------

**Off Characteristics**

Zero Gate Voltage Drain Leakage Current ( $V_{DS} = 68\text{ Vdc}$ , $V_{GS} = 0\text{ Vdc}$ )	$I_{DSS}$	—	—	10	$\mu\text{Adc}$
Zero Gate Voltage Drain Leakage Current ( $V_{DS} = 28\text{ Vdc}$ , $V_{GS} = 0\text{ Vdc}$ )	$I_{DSS}$	—	—	1	$\mu\text{Adc}$
Gate-Source Leakage Current ( $V_{GS} = 5\text{ Vdc}$ , $V_{DS} = 0\text{ Vdc}$ )	$I_{GSS}$	—	—	1	$\mu\text{Adc}$

**On Characteristics**

Gate Threshold Voltage ( $V_{DS} = 10\text{ Vdc}$ , $I_D = 330\ \mu\text{Adc}$ )	$V_{GS(th)}$	1	2	3	Vdc
Gate Quiescent Voltage ( $V_{DS} = 28\text{ Vdc}$ , $I_D = 1050\text{ mAdc}$ )	$V_{GS(Q)}$	—	2.8	—	Vdc
Fixture Gate Quiescent Voltage <sup>(1)</sup> ( $V_{DS} = 28\text{ Vdc}$ , $I_D = 1050\text{ mAdc}$ , Measured in Functional Test)	$V_{GG(Q)}$	2.2	3.1	4.4	Vdc
Drain-Source On-Voltage ( $V_{GS} = 10\text{ Vdc}$ , $I_D = 3.3\text{ Adc}$ )	$V_{DS(on)}$	—	0.24	—	Vdc

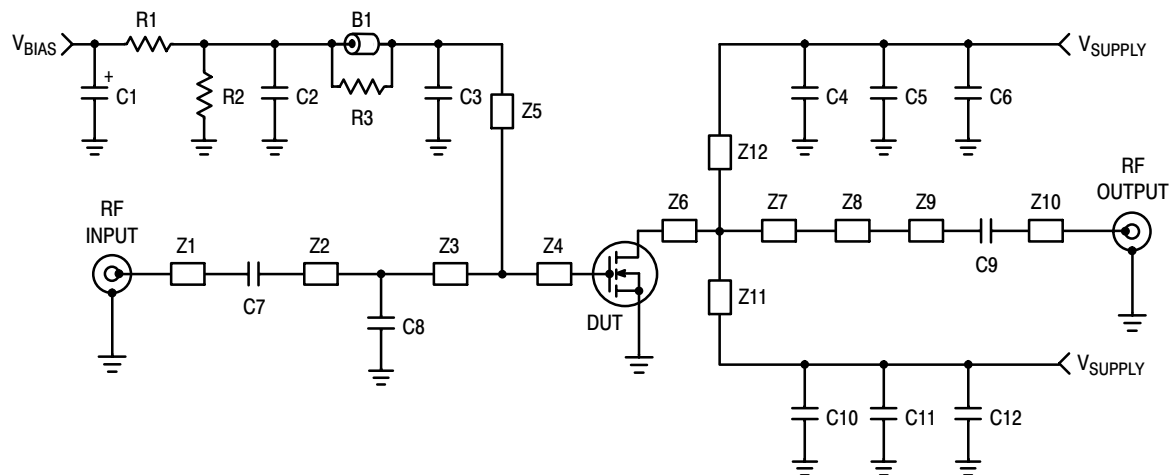
**Dynamic Characteristics <sup>(2)</sup>**

Reverse Transfer Capacitance ( $V_{DS} = 28\text{ Vdc} \pm 30\text{ mV(rms)ac}$ @ 1 MHz, $V_{GS} = 0\text{ Vdc}$ )	$C_{rss}$	—	1.5	—	pF
---	-----------	---	-----	---	----

**Functional Tests** (In Freescale Test Fixture, 50 ohm system)  $V_{DD} = 28\text{ Vdc}$ ,  $I_{DQ} = 1050\text{ mA}$ ,  $P_{out} = 23\text{ W Avg.}$ ,  $f_1 = 2112.5\text{ MHz}$ ,  $f_2 = 2122.5\text{ MHz}$  and  $f_1 = 2157.5\text{ MHz}$ ,  $f_2 = 2167.5\text{ MHz}$ , 2-carrier W-CDMA, 3.84 MHz Channel Bandwidth Carriers, ACPR measured in 3.84 MHz Channel Bandwidth @  $\pm 5\text{ MHz}$  Offset. IM3 measured in 3.84 MHz Bandwidth @  $\pm 10\text{ MHz}$  Offset. PAR = 8.5 dB @ 0.01% Probability on CCDF.

Power Gain	$G_{ps}$	13	14.5	16	dB
Drain Efficiency	$\eta_D$	24	25.5	36	%
Intermodulation Distortion	IM3	-47	-37	-35	dBc
Adjacent Channel Power Ratio	ACPR	-50	-40	-38	dBc
Input Return Loss	IRL	—	-12	-10	dB

- $V_{GG} = 11/10 \times V_{GS(Q)}$ . Parameter measured on Freescale Test Fixture, due to resistive divider network on the board. Refer to Test Circuit schematic.
- Part is internally matched both on input and output.



Z1, Z10	0.743" x 0.084" Microstrip	Z7	0.259" x 0.880" Microstrip
Z2	0.893" x 0.084" Microstrip	Z8	0.215" x 0.230" Microstrip
Z3	0.175" x 0.084" Microstrip	Z9	0.787" x 0.084" Microstrip
Z4	0.420" x 0.800" Microstrip	Z11, Z12	1.171" x 0.120" Microstrip
Z5	1.231" x 0.040" Microstrip	PCB	Arlon AD250, 0.030", $\epsilon_r = 2.5$
Z6	0.100" x 0.880" Microstrip		

**Figure 1. MRF6S21100NR1(NBR1) Test Circuit Schematic**

**Table 6. MRF6S21100NR1(NBR1) Test Circuit Component Designations and Values**

Part	Description	Part Number	Manufacturer
B1	Ferrite Bead	25008051107Y0	Fair-Rite
C1	10 $\mu$ F, 35 V Tantalum Capacitor	T491D106K035AT	Kemet
C2	0.01 $\mu$ F Chip Capacitor	C1825C103J1GAC	Kemet
C3, C4, C10	5.1 pF Chip Capacitors	ATC600B5R1BT250XT	ATC
C5, C6, C11, C12	10 $\mu$ F, 50 V Chip Capacitors	GRM55DR61H106KA88L	Murata
C7	10 pF Chip Capacitor	ATC600B100BT250XT	ATC
C8	1.1 pF Chip Capacitor	ATC600B1R1BT250XT	ATC
C9	5.1 pF Chip Capacitor (MRF6S21100NR1) 8.2 pF Chip Capacitor (MRF6S21100NBR1)	AT600B5R1BT250XT ATC600B8R2BT250XT	ATC ATC
R1	1 k $\Omega$ , 1/4 W Chip Resistor	CRCW12061000FKTA	Vishay
R2	10 k $\Omega$ , 1/4 W Chip Resistor	CRCW12061001FKTA	Vishay
R3	10 $\Omega$ , 1/4 W Chip Resistor	CRCW120610R0FKTA	Vishay

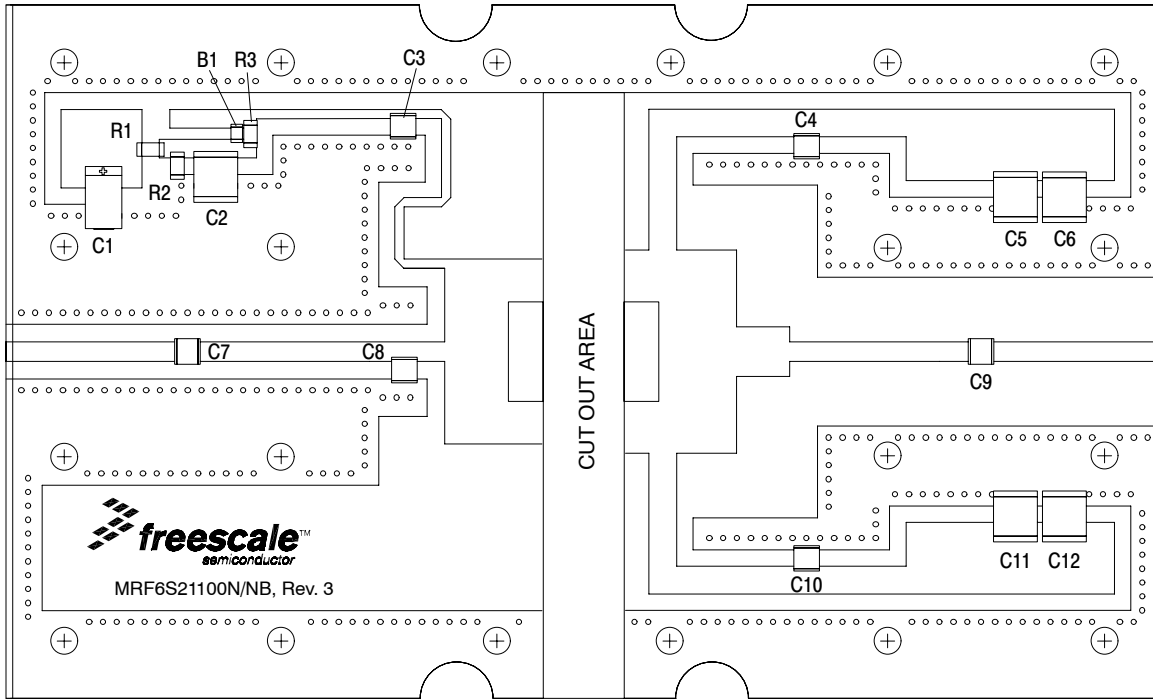
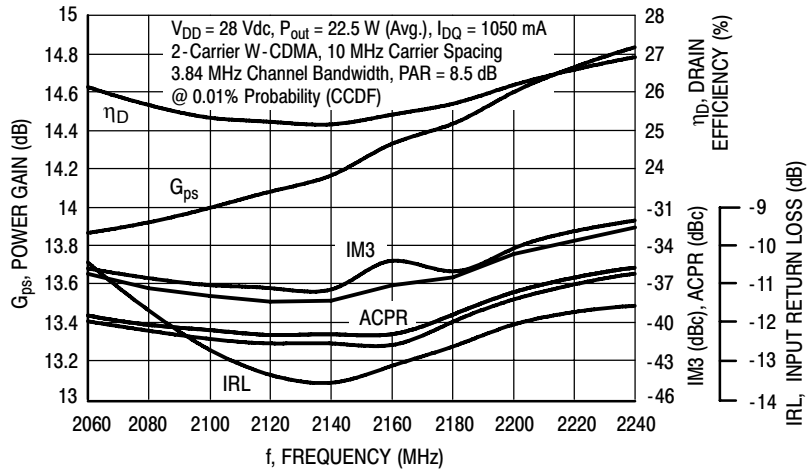
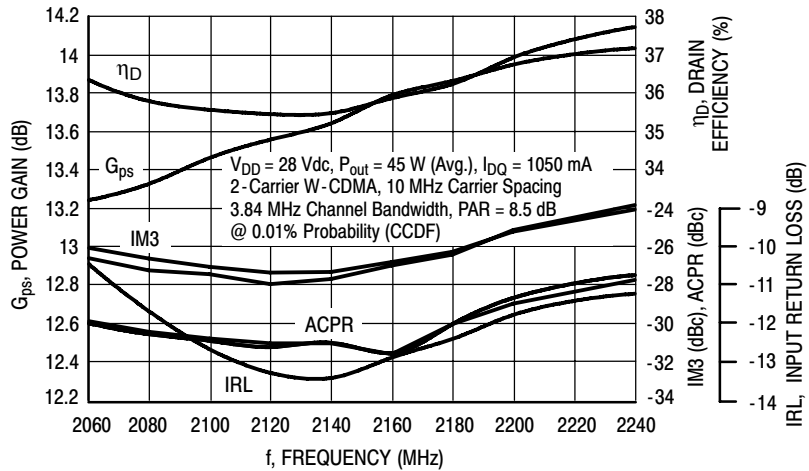


Figure 2. MRF6S21100NR1(NBR1) Test Circuit Component Layout

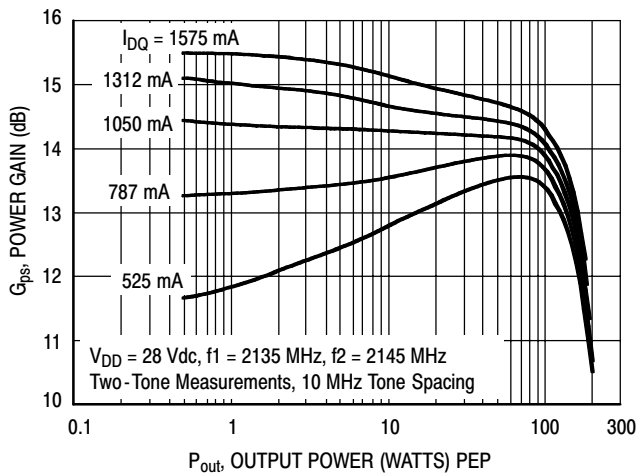
## TYPICAL CHARACTERISTICS



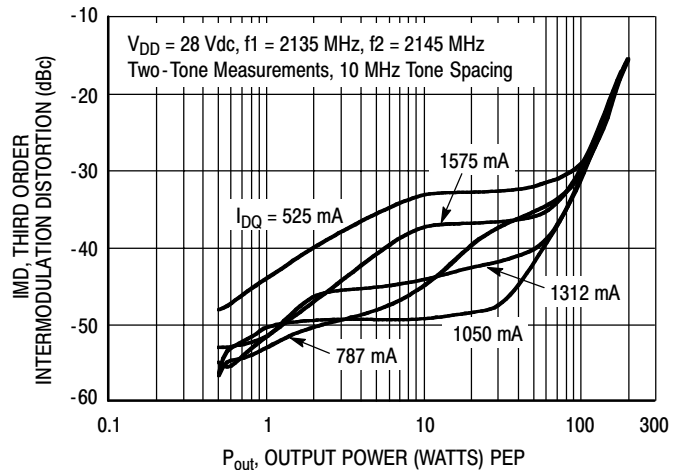
**Figure 3. 2-Carrier W-CDMA Broadband Performance @  $P_{out} = 22.5$  Watts Avg.**



**Figure 4. 2-Carrier W-CDMA Broadband Performance @  $P_{out} = 45$  Watts Avg.**

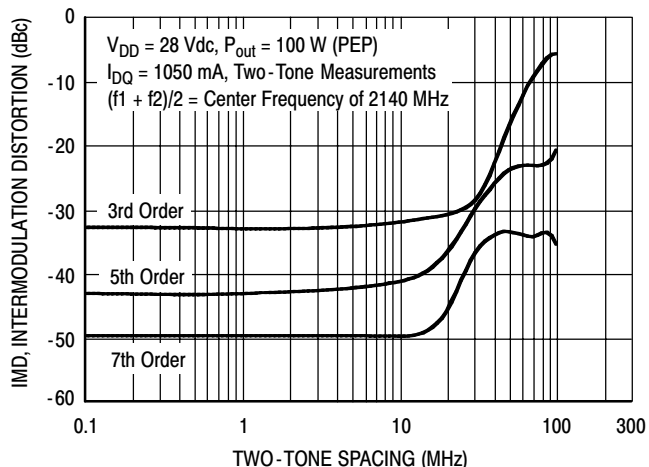


**Figure 5. Two-Tone Power Gain versus Output Power**

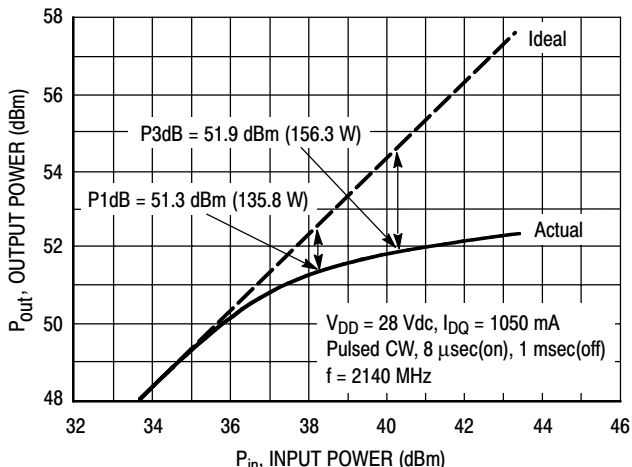


**Figure 6. Third Order Intermodulation Distortion versus Output Power**

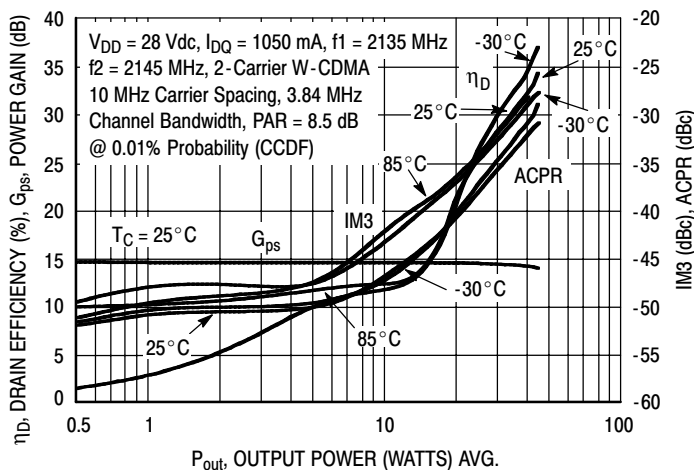
## TYPICAL CHARACTERISTICS



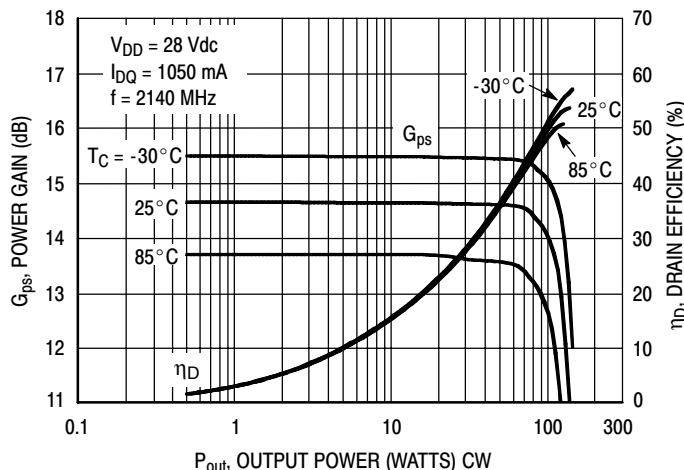
**Figure 7. Intermodulation Distortion Products versus Tone Spacing**



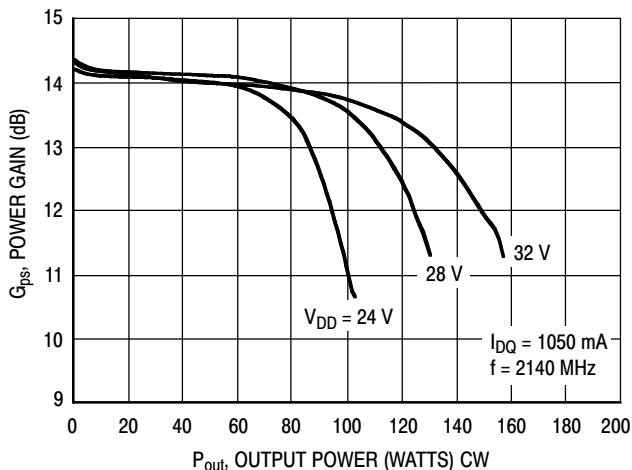
**Figure 8. Pulsed CW Output Power versus Input Power**



**Figure 9. 2-Carrier W-CDMA ACPR, IM3, Power Gain and Drain Efficiency versus Output Power**



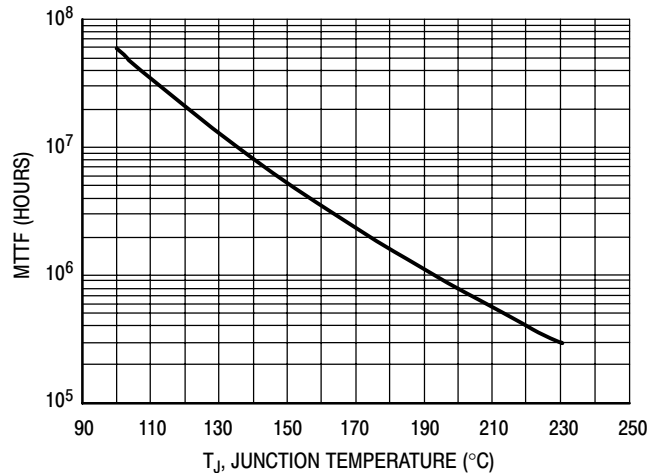
**Figure 10. Power Gain and Drain Efficiency versus CW Output Power**



**Figure 11. Power Gain versus Output Power**

MRF6S21100NR1 MRF6S21100NBR1

## TYPICAL CHARACTERISTICS

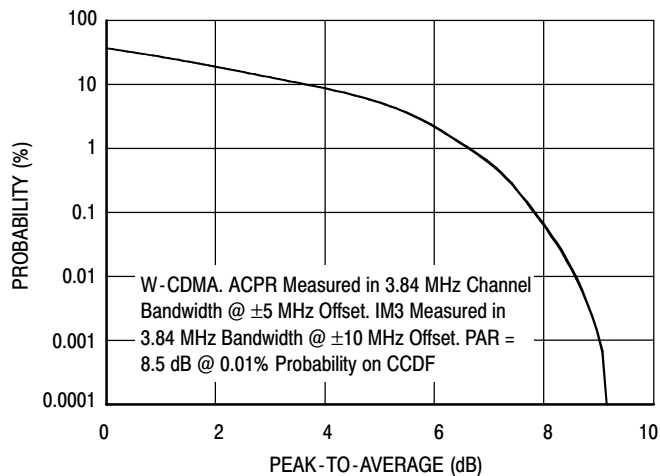


This above graph displays calculated MTTF in hours when the device is operated at  $V_{DD} = 28$  Vdc,  $P_{out} = 23$  W Avg., and  $\eta_D = 25.5\%$ .

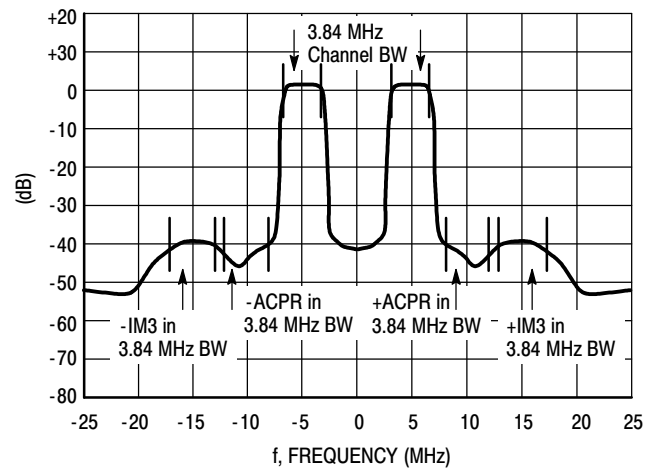
MTTF calculator available at <http://www.freescale.com/rf>. Select Tools/Software/Application Software/Calculators to access the MTTF calculators by product.

**Figure 12. MTTF versus Junction Temperature**

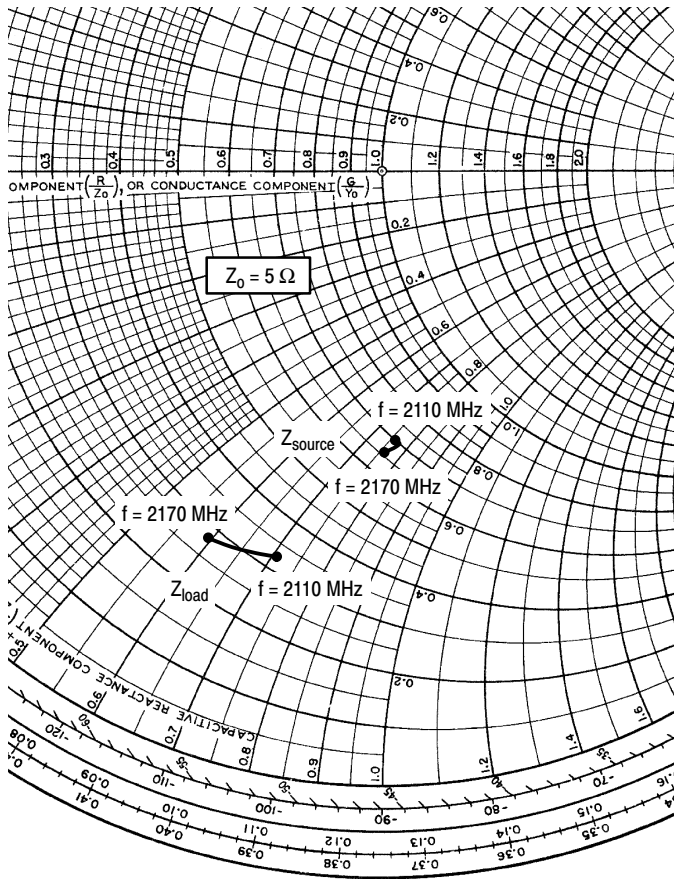
## W-CDMA TEST SIGNAL



**Figure 13. CCDF W-CDMA 3GPP, Test Model 1, 64 DPCH, 67% Clipping, Single-Carrier Test Signal**



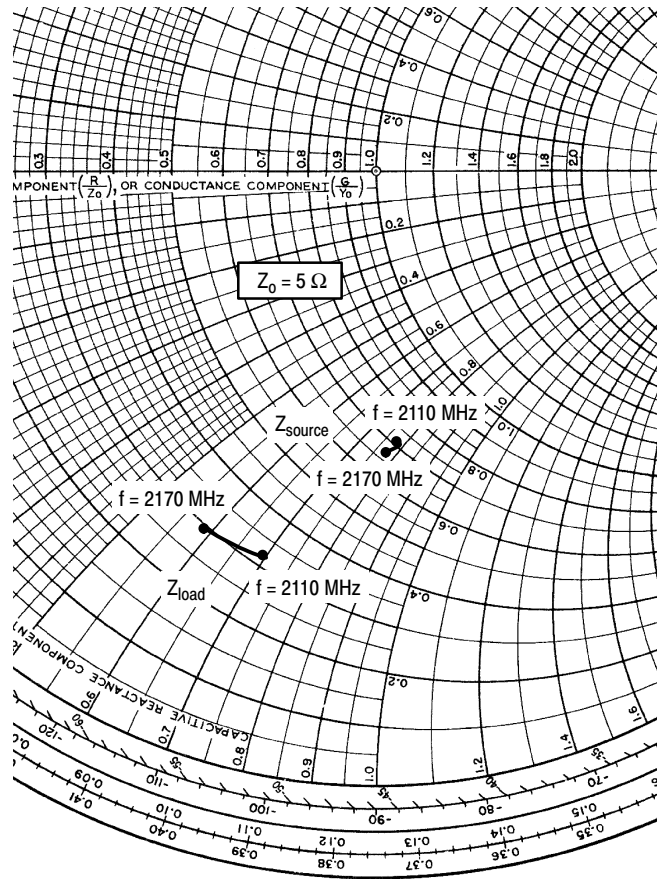
**Figure 14. 2-Carrier W-CDMA Spectrum**



MRF6S21100NR1

$V_{DD} = 28 \text{ Vdc}$ ,  $I_{DQ} = 1050 \text{ mA}$ ,  $P_{out} = 23 \text{ W Avg.}$

f MHz	$Z_{source}$ $\Omega$	$Z_{load}$ $\Omega$
2110	$3.51 - j3.78$	$1.62 - j3.54$
2140	$3.50 - j3.83$	$1.51 - j3.26$
2170	$3.29 - j3.78$	$1.41 - j2.95$



MRF6S21100NBR1

$V_{DD} = 28 \text{ Vdc}$ ,  $I_{DQ} = 1050 \text{ mA}$ ,  $P_{out} = 23 \text{ W Avg.}$

f MHz	$Z_{source}$ $\Omega$	$Z_{load}$ $\Omega$
2110	$3.56 - j3.92$	$1.62 - j3.47$
2140	$3.55 - j3.97$	$1.53 - j3.19$
2170	$3.34 - j3.90$	$1.44 - j2.89$

$Z_{source}$  = Test circuit impedance as measured from gate to gate, balanced configuration.

$Z_{load}$  = Test circuit impedance as measured from drain to drain, balanced configuration.

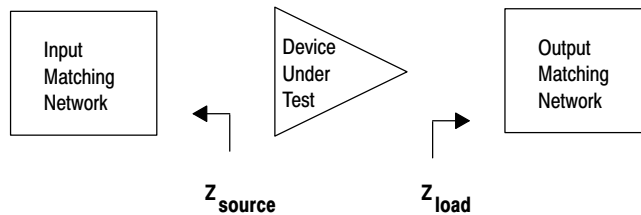
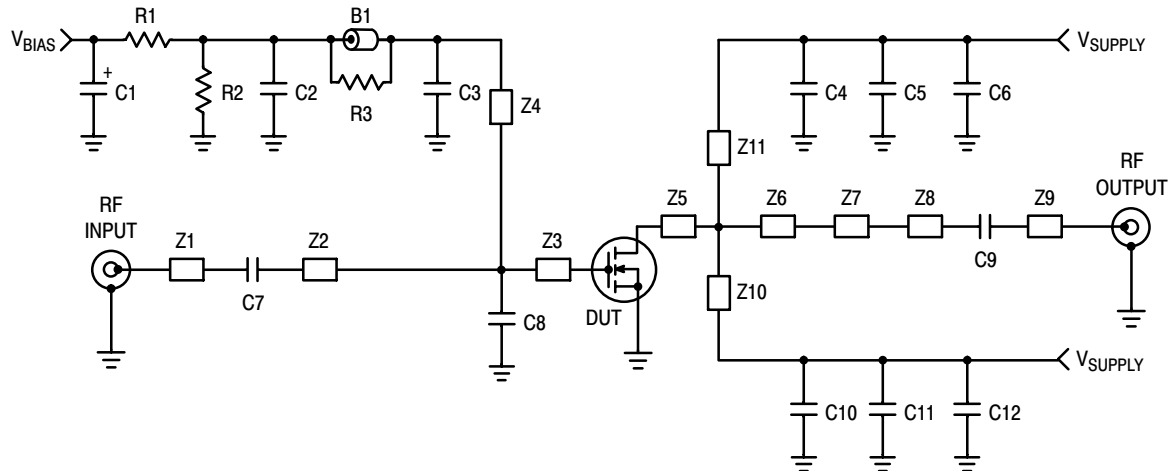


Figure 15. Series Equivalent Source and Load Impedance



## TD-SCDMA CHARACTERIZATION



Z1	1.250" x 0.084" Microstrip	Z7	0.320" x 0.880" Microstrip
Z2	0.930" x 0.084" Microstrip	Z8	0.370" x 0.200" Microstrip
Z3	0.470" x 0.800" Microstrip	Z9	0.650" x 0.084" Microstrip
Z4	0.090" x 0.800" Microstrip	Z10	1.230" x 0.084" Microstrip
Z5	1.500" x 0.040" Microstrip	Z11	0.870" x 0.120" Microstrip
Z6	0.160" x 0.880" Microstrip	PCB	Arlon AD250, 0.030", $\epsilon_r = 2.55$

**Figure 16. MRF6S21100NR1(NBR1) Test Circuit Schematic**

**Table 7. MRF6S21100NR1(NBR1) Test Circuit Component Designations and Values**

Part	Description	Part Number	Manufacturer
B1	Ferrite Bead	25008051107Y0	Fair - Rite
C1	10 $\mu$ F, 35 V Tantalum Capacitor	T491D106K035AT	Kemet
C2	0.01 $\mu$ F Chip Capacitor	C1825C103J1GAC	Kemet
C3, C4, C10	5.1 pF Chip Capacitors	ATC600B5R1BT250XT	ATC
C5, C6, C11, C12	10 $\mu$ F, 50 V Chip Capacitors	GRM55DR61H106KA88L	Murata
C7	10 pF Chip Capacitor	ATC600B100BT250XT	ATC
C8	1.1 pF Chip Capacitor	ATC600B1R1BT250XT	ATC
C9	8.2 pF Chip Capacitor	ATC600B8R2BT250XT	ATC
R1	1 k $\Omega$ , 1/4 W Chip Resistor	CRCW12061000FKTA	Vishay
R2	10 k $\Omega$ , 1/4 W Chip Resistor	CRCW12061001FKTA	Vishay
R3	10 $\Omega$ , 1/4 W Chip Resistor	CRCW120610R0FKTA	Vishay

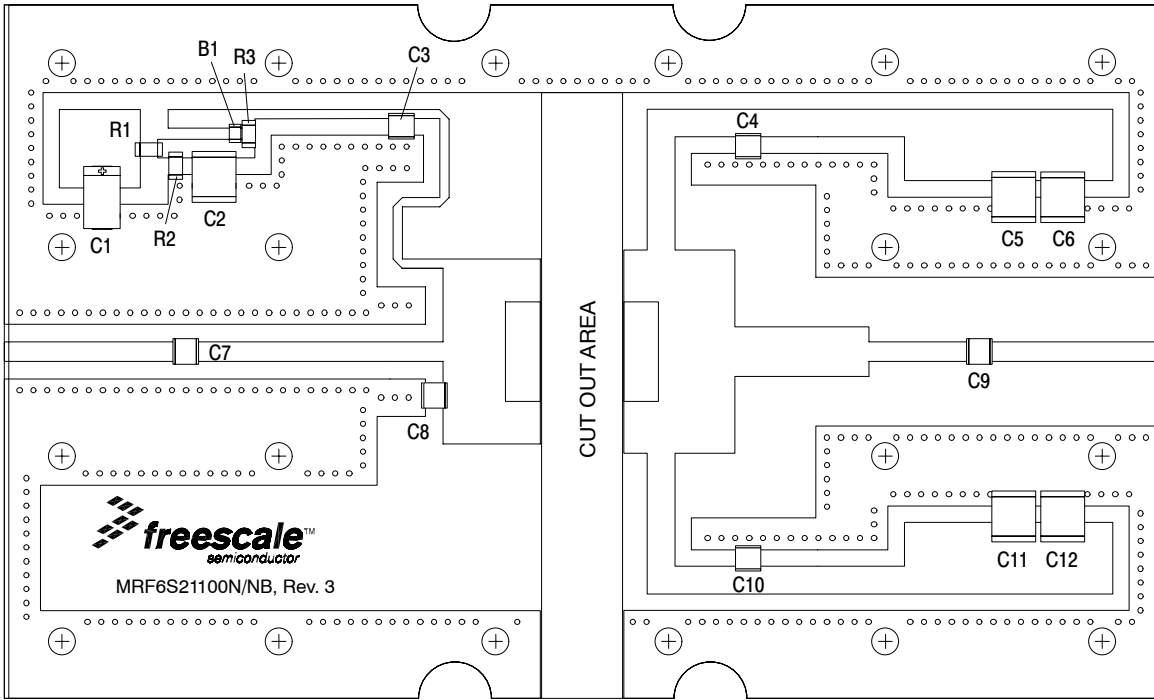
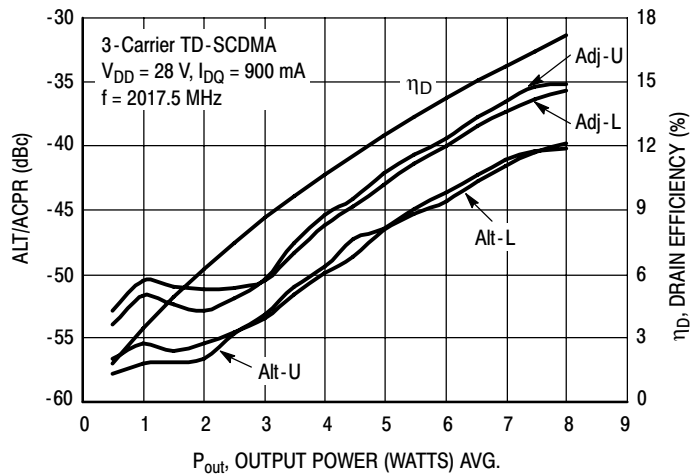
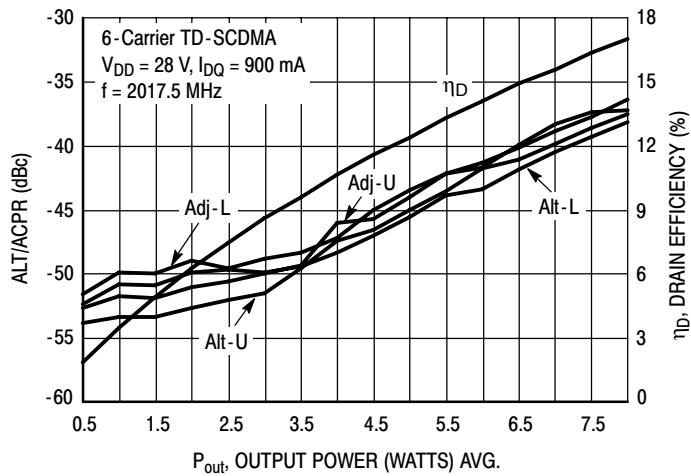


Figure 17. MRF6S21100NR1(NBR1) Test Circuit Component Layout — TD-SCDMA

## TYPICAL CHARACTERISTICS

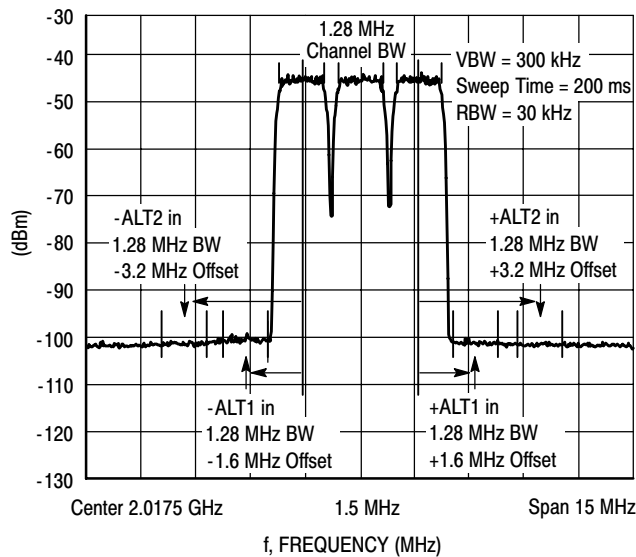


**Figure 18. 3-Carrier TD-SCDMA ACPR, ALT and Drain Efficiency versus Output Power**

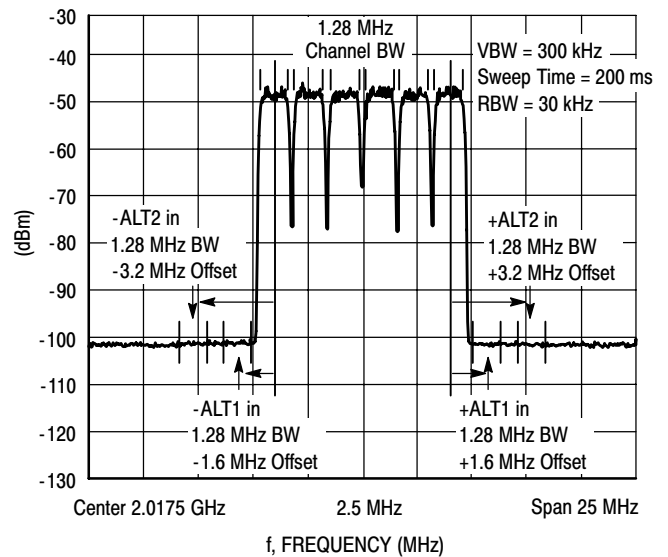


**Figure 19. 6-Carrier TD-SCDMA ACPR, ALT and Drain Efficiency versus Output Power**

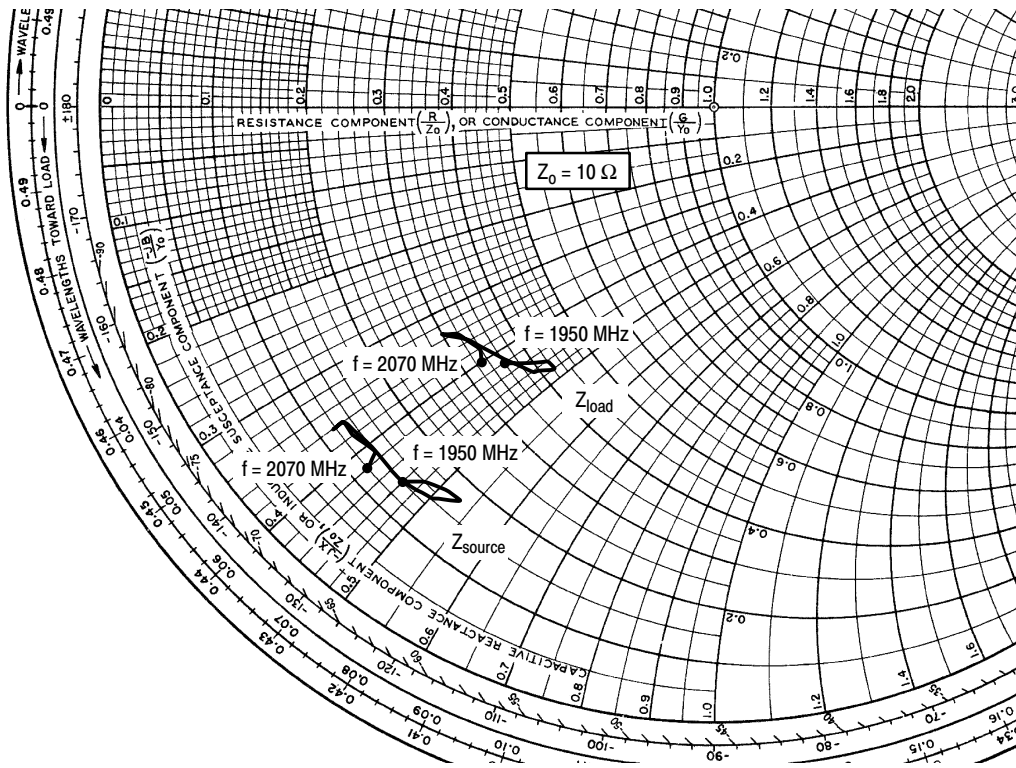
## TD-SCDMA TEST SIGNAL



**Figure 20. 3-Carrier TD-SCDMA Spectrum**



**Figure 21. 6-Carrier TD-SCDMA Spectrum**



$V_{DD} = 28 \text{ Vdc}$ ,  $I_{DQ} = 900 \text{ mA}$

f MHz	$Z_{\text{source}}$ $\Omega$	$Z_{\text{load}}$ $\Omega$
1950	1.43 - j4.56	3.61 - j4.19
1960	1.57 - j4.80	3.86 - j4.40
1970	1.72 - j5.12	4.18 - j4.62
1980	1.65 - j5.27	4.21 - j4.81
1990	1.48 - j4.98	3.91 - j4.59
2000	1.38 - j4.45	3.56 - j4.07
2010	1.35 - j4.01	3.31 - j3.62
2020	1.30 - j3.57	3.14 - j3.40
2030	1.21 - j3.62	2.99 - j3.31
2040	1.25 - j3.61	3.02 - j3.31
2050	1.34 - j3.76	3.19 - j3.44
2060	1.37 - j4.08	3.38 - j3.75
2070	1.24 - j4.24	3.33 - j3.99

$Z_{\text{source}}$  = Device input impedance as measured from gate to ground.

$Z_{\text{load}}$  = Test circuit impedance as measured from drain to ground.

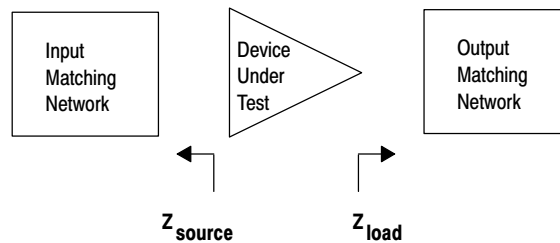
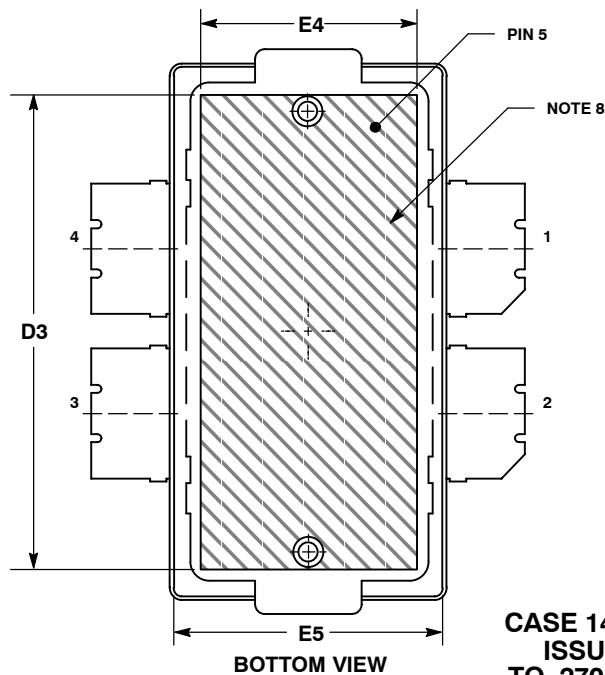
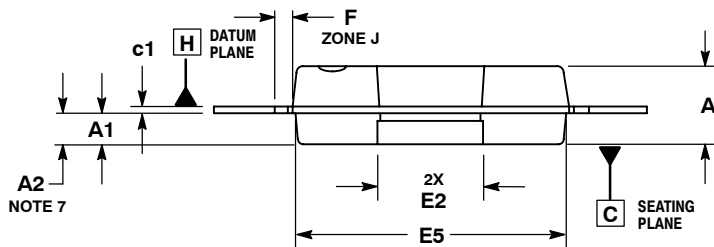
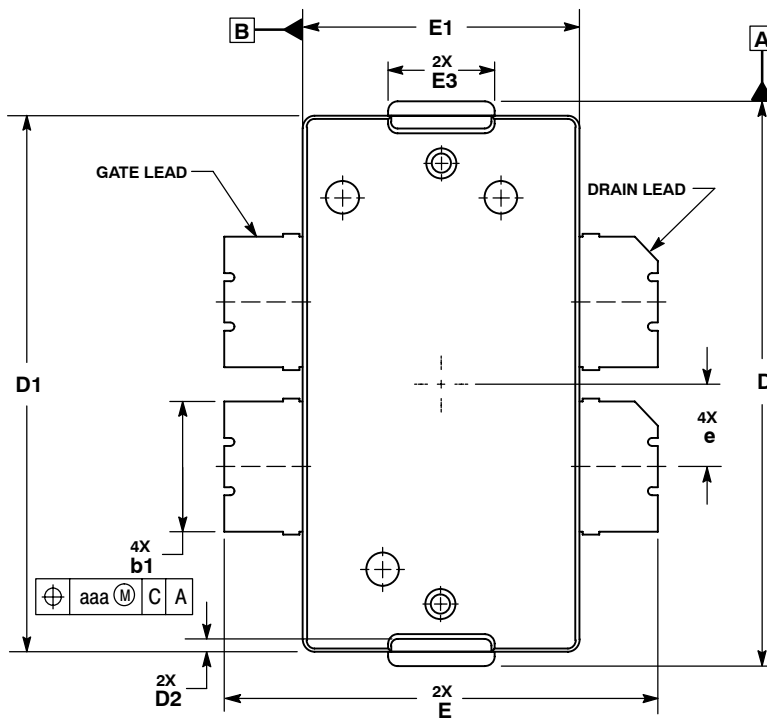


Figure 22. Series Equivalent Source and Load Impedance — TD-SCDMA

# PACKAGE DIMENSIONS



**CASE 1486-03  
ISSUE C  
TO-270 WB-4  
PLASTIC  
MRF6S21100NR1**

**NOTES:**

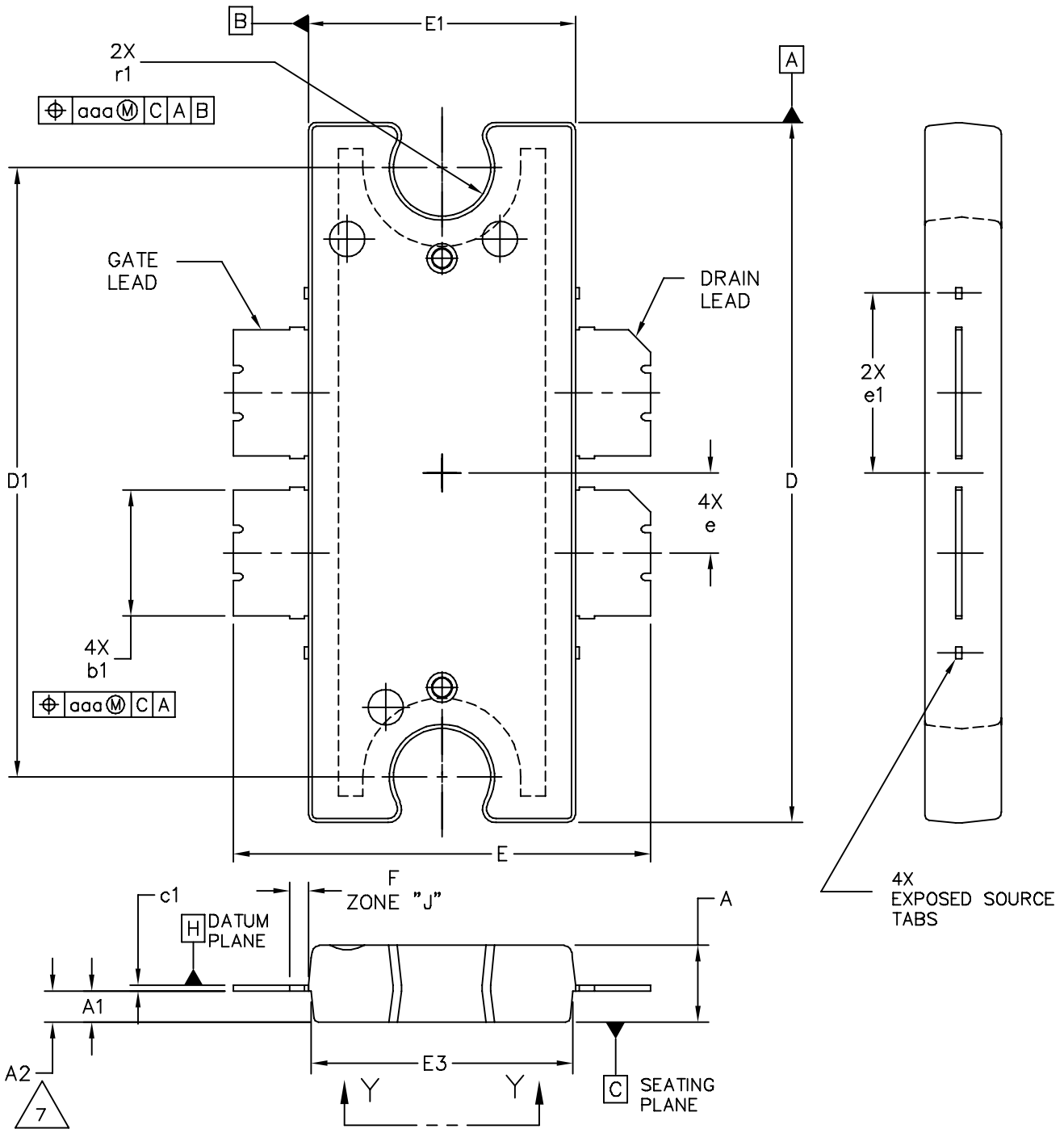
1. CONTROLLING DIMENSION: INCH.
2. INTERPRET DIMENSIONS AND TOLERANCES PER ASME Y14.5M-1994.
3. DATUM PLANE -H- IS LOCATED AT THE TOP OF LEAD AND IS COINCIDENT WITH THE LEAD WHERE THE LEAD EXITS THE PLASTIC BODY AT THE TOP OF THE PARTING LINE.
4. DIMENSIONS "D" AND "E1" DO NOT INCLUDE MOLD PROTRUSION. ALLOWABLE PROTRUSION IS .006 PER SIDE. DIMENSIONS "D" AND "E1" DO INCLUDE MOLD MISMATCH AND ARE DETERMINED AT DATUM PLANE -H-.
5. DIMENSION "b1" DOES NOT INCLUDE DAMBAR PROTRUSION. ALLOWABLE DAMBAR PROTRUSION SHALL BE .005 TOTAL IN EXCESS OF THE "b1" DIMENSION AT MAXIMUM MATERIAL CONDITION.
6. DATUMS -A- AND -B- TO BE DETERMINED AT DATUM PLANE -H-.
7. DIMENSION A2 APPLIES WITHIN ZONE "J" ONLY.
8. HATCHING REPRESENTS THE EXPOSED AREA OF THE HEAT SLUG.

DIM	INCHES		MILLIMETERS	
	MIN	MAX	MIN	MAX
A	.100	.104	2.54	2.64
A1	.039	.043	0.99	1.09
A2	.040	.042	1.02	1.07
D	.712	.720	18.08	18.29
D1	.688	.692	17.48	17.58
D2	.011	.019	0.28	0.48
D3	.600	---	15.24	---
E	.551	.559	14	14.2
E1	.353	.357	8.97	9.07
E2	.132	.140	3.35	3.56
E3	.124	.132	3.15	3.35
E4	.270	---	6.86	---
E5	.346	.350	8.79	8.89
F	.025 BSC		0.64 BSC	
b1	.164	.170	4.17	4.32
c1	.007	.011	0.18	0.28
e	.106 BSC		2.69 BSC	
aaa	.004		0.10	

**STYLE 1:**

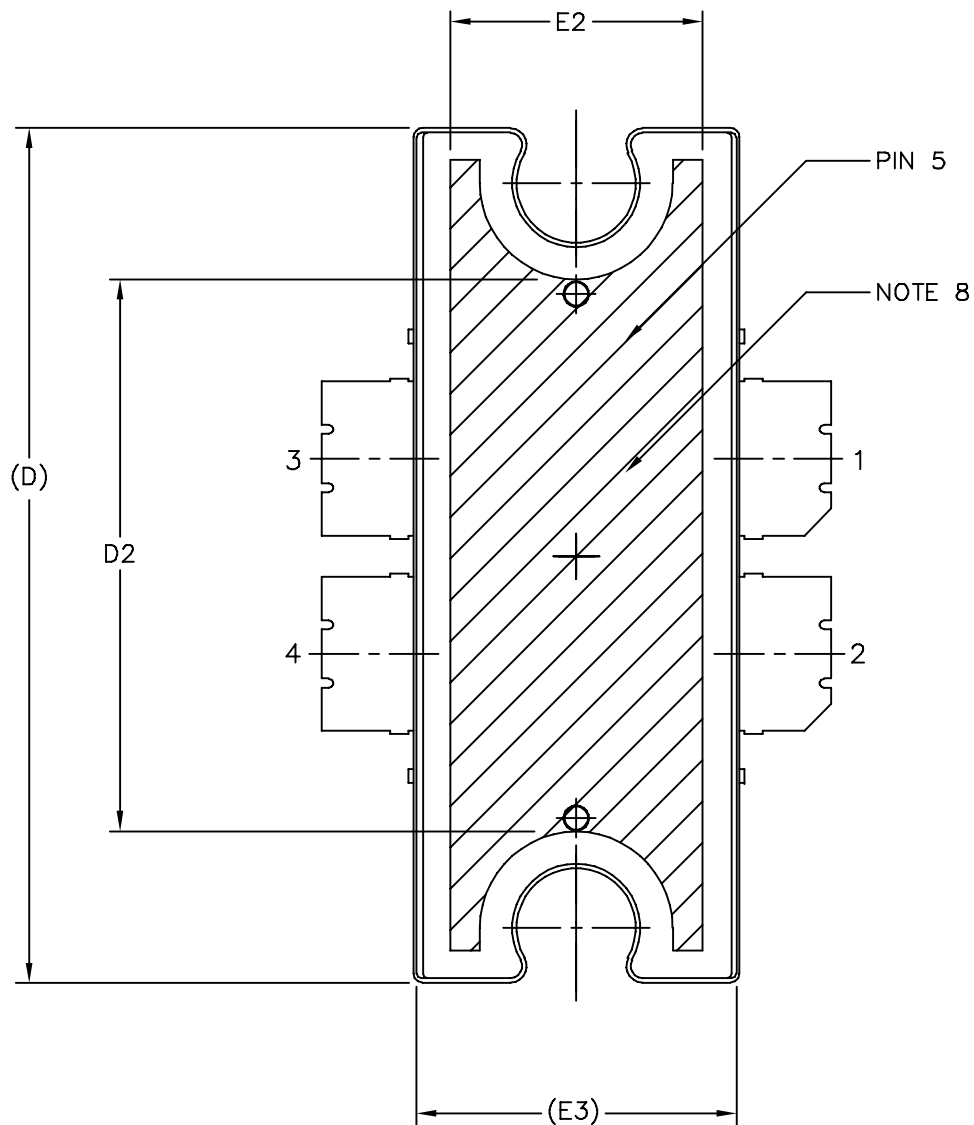
- PIN 1. DRAIN
- DRAIN
- GATE
- GATE
- SOURCE

MRF6S21100NR1 MRF6S21100NBR1



© FREESCALE SEMICONDUCTOR, INC. ALL RIGHTS RESERVED.		<b>MECHANICAL OUTLINE</b>		PRINT VERSION NOT TO SCALE	
TITLE: <b>TO-272</b> <b>4 LEAD, WIDE BODY</b>		DOCUMENT NO: 98ASA10575D		REV: D	
		CASE NUMBER: 1484-04		05 APR 2006	
		STANDARD: NON-JEDEC			

**MRF6S21100NR1 MRF6S21100NBR1**



© FREESCALE SEMICONDUCTOR, INC. ALL RIGHTS RESERVED.	<b>MECHANICAL OUTLINE</b>	PRINT VERSION NOT TO SCALE	
TITLE: TO-272 4 LEAD, WIDE BODY	DOCUMENT NO: 98ASA10575D	REV: D	
	CASE NUMBER: 1484-04	05 APR 2006	
	STANDARD: NON-JEDEC		

MRF6S21100NR1 MRF6S21100NBR1

NOTES:

1. CONTROLLING DIMENSION: INCH
2. INTERPRET DIMENSIONS AND TOLERANCES PER ASME Y14.5M-1994.
3. DATUM PLANE H IS LOCATED AT THE TOP OF LEAD AND IS COINCIDENT WITH THE LEAD WHERE THE LEAD EXITS THE PLASTIC BODY AT THE TOP OF THE PARTING LINE.
4. DIMENSIONS "D" AND "E1" DO NOT INCLUDE MOLD PROTRUSION. ALLOWABLE PROTRUSION IS .006 PER SIDE. DIMENSIONS "D" AND "E1" DO INCLUDE MOLD MISMATCH AND ARE DETERMINED AT DATUM PLANE H.
5. DIMENSIONS "b1" DOES NOT INCLUDE DAMBAR PROTRUSION. ALLOWABLE DAMBAR PROTRUSION SHALL BE .005 TOTAL IN EXCESS OF THE "b1" DIMENSION AT MAXIMUM MATERIAL CONDITION.
6. DATUM A AND B TO BE DETERMINED AT DATUM PLANE H.
7. DIMENSION A2 APPLIES WITHIN ZONE "J" ONLY.
8. HATCHING REPRESENTS EXPOSED AREA OF THE HEAT SLUG. HATCHED AREA SHOWN IS ON THE SAME PLANE.

STYLE 1:

PIN 1 - DRAIN      PIN 2 - DRAIN  
 PIN 3 - GATE      PIN 4 - GATE  
 PIN 5 - SOURCE

DIM	INCH		MILLIMETER		DIM	INCH		MILLIMETER	
	MIN	MAX	MIN	MAX		MIN	MAX	MIN	MAX
A	.100	.104	2.54	2.64	b1	.164	.170	4.17	4.32
A1	.039	.043	0.99	1.09	c1	.007	.011	.18	.28
A2	.040	.042	1.02	1.07	r1	.063	.068	1.60	1.73
D	.928	.932	23.57	23.67	e	.106 BSC		2.69 BSC	
D1	.810 BSC		20.57 BSC		e1	.239 INFO ONLY		6.07 INFO ONLY	
D2	.600	---	15.24	---	aaa	.004		.10	
E	.551	.559	14	14.2					
E1	.353	.357	8.97	9.07					
E2	.270	---	6.86	---					
E3	.346	.350	8.79	8.89					
F	.025 BSC		0.64 BSC						

© FREESCALE SEMICONDUCTOR, INC. ALL RIGHTS RESERVED.		<b>MECHANICAL OUTLINE</b>		PRINT VERSION NOT TO SCALE	
TITLE:  TO-272 4 LEAD WIDE BODY		DOCUMENT NO: 98ASA10575D		REV: D	
		CASE NUMBER: 1484-04		05 APR 2006	
		STANDARD: NON-JEDEC			



## PRODUCT DOCUMENTATION

Refer to the following documents to aid your design process.

### Application Notes

- AN1907: Solder Reflow Attach Method for High Power RF Devices in Plastic Packages
- AN1955: Thermal Measurement Methodology of RF Power Amplifiers
- AN3263: Bolt Down Mounting Method for High Power RF Transistors and RFICs in Over-Molded Plastic Packages

### Engineering Bulletins

- EB212: Using Data Sheet Impedances for RF LDMOS Devices

## REVISION HISTORY

The following table summarizes revisions to this document.

Revision	Date	Description
2	Jan. 2007	<ul style="list-style-type: none"><li>• Added "TD-SCDMA" to data sheet description paragraph, p. 1</li><li>• Removed Total Device Dissipation from Max Ratings table as data was redundant (information already provided in Thermal Characteristics table), p. 1</li><li>• Added <math>V_{GG(Q)}</math> and removed Min and Max value for <math>V_{GS(Q)}</math> in On Characteristics table to account for the test fixture's resistor divider network, p. 2</li><li>• Removed Forward Transconductance from On Characteristics table as it no longer provided usable information, p. 2</li><li>• Updated Part Numbers in Table 6, Component Designations and Values, to RoHS compliant part numbers, p. 3</li><li>• Adjusted scale for Fig. 5, Two-Tone Power Gain versus Output Power, to better match the device's capabilities, p. 5</li><li>• Removed lower voltage tests from Fig. 11, Power Gain versus Output Power, due to fixed tuned fixture limitations, p. 6</li><li>• Replaced Fig. 12, MTF versus Junction Temperature with updated graph. Removed Amps<sup>2</sup> and listed operating characteristics and location of MTF calculator for device, p. 7</li><li>• Added TD-SCDMA test circuit schematic, component designations and values, component layout, typical characteristic curves, test signal and series impedance, p. 9-12</li><li>• Added Product Documentation and Revision History, p. 17</li></ul>

## **How to Reach Us:**

### **Home Page:**

[www.freescale.com](http://www.freescale.com)

### **Web Support:**

<http://www.freescale.com/support>

### **USA/Europe or Locations Not Listed:**

Freescale Semiconductor, Inc.  
Technical Information Center, EL516  
2100 East Elliot Road  
Tempe, Arizona 85284  
+1-800-521-6274 or +1-480-768-2130  
[www.freescale.com/support](http://www.freescale.com/support)

### **Europe, Middle East, and Africa:**

Freescale Halbleiter Deutschland GmbH  
Technical Information Center  
Schatzbogen 7  
81829 Muenchen, Germany  
+44 1296 380 456 (English)  
+46 8 52200080 (English)  
+49 89 92103 559 (German)  
+33 1 69 35 48 48 (French)  
[www.freescale.com/support](http://www.freescale.com/support)

### **Japan:**

Freescale Semiconductor Japan Ltd.  
Headquarters  
ARCO Tower 15F  
1-8-1, Shimo-Meguro, Meguro-ku,  
Tokyo 153-0064  
Japan  
0120 191014 or +81 3 5437 9125  
[support.japan@freescale.com](mailto:support.japan@freescale.com)

### **Asia/Pacific:**

Freescale Semiconductor Hong Kong Ltd.  
Technical Information Center  
2 Dai King Street  
Tai Po Industrial Estate  
Tai Po, N.T., Hong Kong  
+800 2666 8080  
[support.asia@freescale.com](mailto:support.asia@freescale.com)

### **For Literature Requests Only:**

Freescale Semiconductor Literature Distribution Center  
P.O. Box 5405  
Denver, Colorado 80217  
1-800-441-2447 or 303-675-2140  
Fax: 303-675-2150  
[LDCForFreescaleSemiconductor@hibbertgroup.com](mailto:LDCForFreescaleSemiconductor@hibbertgroup.com)

Information in this document is provided solely to enable system and software implementers to use Freescale Semiconductor products. There are no express or implied copyright licenses granted hereunder to design or fabricate any integrated circuits or integrated circuits based on the information in this document.

Freescale Semiconductor reserves the right to make changes without further notice to any products herein. Freescale Semiconductor makes no warranty, representation or guarantee regarding the suitability of its products for any particular purpose, nor does Freescale Semiconductor assume any liability arising out of the application or use of any product or circuit, and specifically disclaims any and all liability, including without limitation consequential or incidental damages. "Typical" parameters that may be provided in Freescale Semiconductor data sheets and/or specifications can and do vary in different applications and actual performance may vary over time. All operating parameters, including "Typicals", must be validated for each customer application by customer's technical experts. Freescale Semiconductor does not convey any license under its patent rights nor the rights of others. Freescale Semiconductor products are not designed, intended, or authorized for use as components in systems intended for surgical implant into the body, or other applications intended to support or sustain life, or for any other application in which the failure of the Freescale Semiconductor product could create a situation where personal injury or death may occur. Should Buyer purchase or use Freescale Semiconductor products for any such unintended or unauthorized application, Buyer shall indemnify and hold Freescale Semiconductor and its officers, employees, subsidiaries, affiliates, and distributors harmless against all claims, costs, damages, and expenses, and reasonable attorney fees arising out of, directly or indirectly, any claim of personal injury or death associated with such unintended or unauthorized use, even if such claim alleges that Freescale Semiconductor was negligent regarding the design or manufacture of the part.

Freescale™ and the Freescale logo are trademarks of Freescale Semiconductor, Inc. All other product or service names are the property of their respective owners.  
© Freescale Semiconductor, Inc. 2007. All rights reserved.

