



# RF Power Field Effect Transistors

## N-Channel Enhancement-Mode Lateral MOSFETs

Designed for W-CDMA base station applications with frequencies from 2110 to 2170 MHz. Suitable for TDMA, CDMA and multicarrier amplifier applications. To be used in Class AB for PCN - PCS/cellular radio and WLL applications.

- Typical 2-carrier W-CDMA Performance:  $V_{DD} = 28$  Volts,  $I_{DQ} = 450$  mA,  $P_{out} = 11.5$  Watts Avg., Full Frequency Band, Channel Bandwidth = 3.84 MHz, PAR = 8.5 dB @ 0.01% Probability on CCDF.  
 Power Gain — 16 dB  
 Drain Efficiency — 27.7%  
 IM3 @ 10 MHz Offset — -37 dBc in 3.84 MHz Channel Bandwidth  
 ACPR @ 5 MHz Offset — -40 dBc in 3.84 MHz Channel Bandwidth
- Capable of Handling 10:1 VSWR, @ 28 Vdc, 2140 MHz, 50 Watts CW Output Power

### Features

- Characterized with Series Equivalent Large-Signal Impedance Parameters
- Internally Matched for Ease of Use
- Qualified Up to a Maximum of 32  $V_{DD}$  Operation
- Integrated ESD Protection
- Designed for Lower Memory Effects and Wide Instantaneous Bandwidth Applications
- Low Gold Plating Thickness on Leads, 40 $\mu$ ” Nominal.
- RoHS Compliant
- In Tape and Reel. R3 Suffix = 250 Units per 32 mm, 13 inch Reel.

**MRF6S21050LR3**  
**MRF6S21050LSR3**

**2110-2170 MHz, 11.5 W AVG., 28 V**  
**2 x W-CDMA**  
**LATERAL N-CHANNEL**  
**RF POWER MOSFETs**

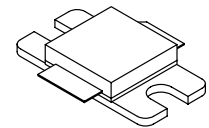

**CASE 465E-04, STYLE 1**  
**NI-400**  
**MRF6S21050LR3**

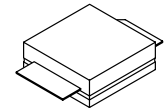

**CASE 465F-04, STYLE 1**  
**NI-400S**  
**MRF6S21050LSR3**

**Table 1. Maximum Ratings**

Rating	Symbol	Value	Unit
Drain-Source Voltage	$V_{DSS}$	-0.5, +68	Vdc
Gate-Source Voltage	$V_{GS}$	-0.5, +12	Vdc
Total Device Dissipation @ $T_C = 25^\circ\text{C}$ Derate above 25°C	$P_D$	151 0.86	W W/°C
Storage Temperature Range	$T_{stg}$	- 65 to +150	°C
Case Operating Temperature	$T_C$	150	°C
Operating Junction Temperature	$T_J$	200	°C

**Table 2. Thermal Characteristics**

Characteristic	Symbol	Value (1,2)	Unit
Thermal Resistance, Junction to Case Case Temperature 80°C, 50 W CW Case Temperature 76°C, 12 W CW	$R_{\theta JC}$	1.16 1.28	°C/W

**Table 3. ESD Protection Characteristics**

Test Methodology	Class
Human Body Model (per JESD22-A114)	1C (Minimum)
Machine Model (per EIA/JESD22-A115)	A (Minimum)
Charge Device Model (per JESD22-C101)	III (Minimum)

**Table 4. Electrical Characteristics** ( $T_C = 25^\circ\text{C}$  unless otherwise noted)

Characteristic	Symbol	Min	Typ	Max	Unit
----------------	--------	-----	-----	-----	------

**Off Characteristics**

Zero Gate Voltage Drain Leakage Current ( $V_{DS} = 68\text{ Vdc}$ , $V_{GS} = 0\text{ Vdc}$ )	$I_{DSS}$	—	—	10	$\mu\text{Adc}$
Zero Gate Voltage Drain Leakage Current ( $V_{DS} = 28\text{ Vdc}$ , $V_{GS} = 0\text{ Vdc}$ )	$I_{DSS}$	—	—	1	$\mu\text{Adc}$
Gate-Source Leakage Current ( $V_{GS} = 5\text{ Vdc}$ , $V_{DS} = 0\text{ Vdc}$ )	$I_{GSS}$	—	—	1	$\mu\text{Adc}$

**On Characteristics**

Gate Threshold Voltage ( $V_{DS} = 10\text{ Vdc}$ , $I_D = 200\ \mu\text{Adc}$ )	$V_{GS(th)}$	1	2	3	Vdc
Gate Quiescent Voltage ( $V_{DS} = 28\text{ Vdc}$ , $I_D = 450\text{ mAdc}$ )	$V_{GS(Q)}$	2	2.9	4	Vdc
Drain-Source On-Voltage ( $V_{GS} = 10\text{ Vdc}$ , $I_D = 1.1\text{ Adc}$ )	$V_{DS(on)}$	—	0.21	0.3	Vdc
Forward Transconductance ( $V_{DS} = 10\text{ Vdc}$ , $I_D = 1\text{ Adc}$ )	$g_{fs}$	—	5.3	—	S

**Dynamic Characteristics** <sup>(3)</sup>

Reverse Transfer Capacitance ( $V_{DS} = 28\text{ Vdc} \pm 30\text{ mV(rms)ac}$ @ 1 MHz, $V_{GS} = 0\text{ Vdc}$ )	$C_{rss}$	—	0.75	—	pF
---	-----------	---	------	---	----

**Functional Tests** (In Freescale Test Fixture, 50 ohm system)  $V_{DD} = 28\text{ Vdc}$ ,  $I_{DQ} = 450\text{ mA}$ ,  $P_{out} = 11.5\text{ W Avg.}$ ,  $f_1 = 2112.5\text{ MHz}$ ,  $f_2 = 2122.5\text{ MHz}$  and  $f_1 = 2157.5\text{ MHz}$ ,  $f_2 = 2167.5\text{ MHz}$ , 2-carrier W-CDMA, 3.84 MHz Channel Bandwidth Carriers. ACPR measured in 3.84 MHz Channel Bandwidth @  $\pm 5\text{ MHz}$  Offset. IM3 measured in 3.84 MHz Bandwidth @  $\pm 10\text{ MHz}$  Offset. PAR = 8.5 dB @ 0.01% Probability on CCDF.

Power Gain	$G_{ps}$	15	16	18	dB
Drain Efficiency	$\eta_D$	26	27.7	—	%
Intermodulation Distortion	IM3	—	-37	-35	dBc
Adjacent Channel Power Ratio	ACPR	—	-40	-38	dBc
Input Return Loss	IRL	—	-15	-9	dB

1. MTTF calculator available at <http://www.freescale.com/rf>. Select Tools/Software/Application Software/Calculators to access the MTTF calculators by product.
2. Refer to AN1955, *Thermal Measurement Methodology of RF Power Amplifiers*. Go to <http://www.freescale.com/rf>. Select Documentation/Application Notes - AN1955.
3. Part is internally matched both on input and output.

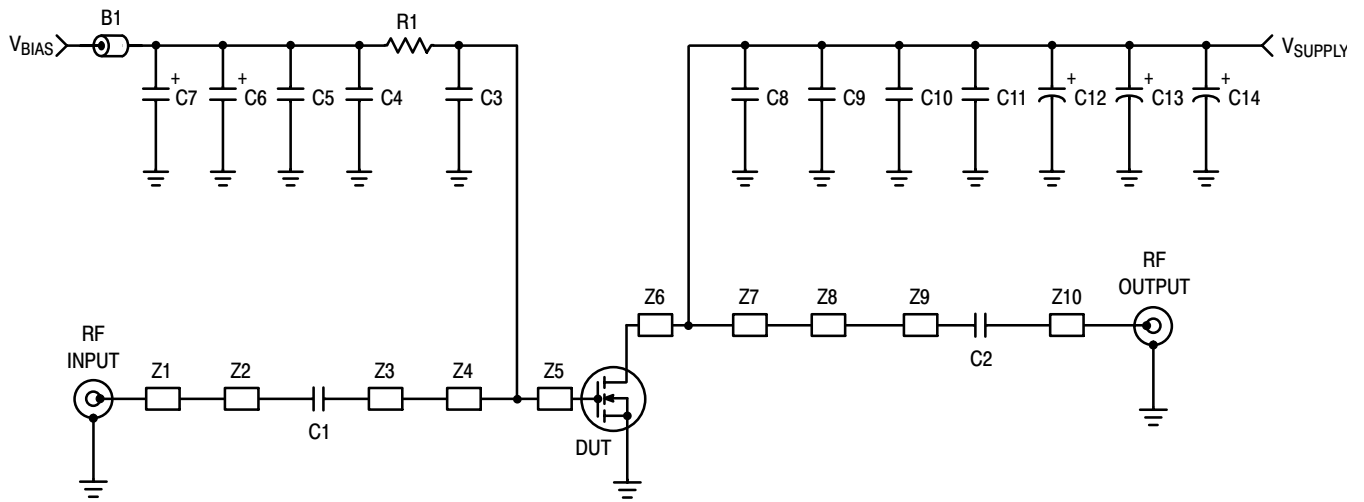

Z1, Z10	0.750" x 0.084" Microstrip	Z6	0.113" x 0.590" Microstrip
Z2	0.905" x 0.084" Microstrip	Z7	0.325" x 0.590" Microstrip
Z3	0.435" x 0.173" Microstrip	Z8	0.214" x 0.150" Microstrip
Z4	0.073" x 0.333" Microstrip	Z9	0.723" x 0.084" Microstrip
Z5	0.070" x 0.333" Microstrip	PCB	Arlon GX-0300-5022, 0.030", $\epsilon_r = 2.5$

Figure 1. MRF6S21050LR3 (LSR3) Test Circuit Schematic

Table 5. MRF6S21050LR3 (LSR3) Test Circuit Component Designations and Values

Part	Description	Part Number	Manufacturer
B1	Bead, Surface Mount	2743019447	Fair-Rite
C1, C2, C3, C8	6.8 pF Chip Capacitors	100B6R8CP500X	ATC
C4	0.01 $\mu$ F Chip Capacitor (1825)	C1825C103J1RAC	Kemet
C5, C11	2.2 $\mu$ F, 50 V Chip Capacitors (1825)	C1825C225J5RAC	Kemet
C6	22 $\mu$ F, 25 V Tantalum Capacitor	ECS-T1ED226R	Panasonic TE Series
C7	47 $\mu$ F, 16 V Tantalum Capacitor	T491D476K016AS	Kemet
C9, C10	10 $\mu$ F, 50 V Chip Capacitors (2220)	GRM55DR61H106KA88B	Murata
C12	47 $\mu$ F, 50 V Electrolytic Capacitor	MVK50VC47RM8X10TP	Nippon
C13, C14	220 $\mu$ F, 50 V Electrolytic Capacitors	MVY50VC221MJ10TP	Nippon
R1	3.3 $\Omega$ , 1/4 W Chip Resistor (1210)	ERJ-14YJ3R3U	Dale/Vishay

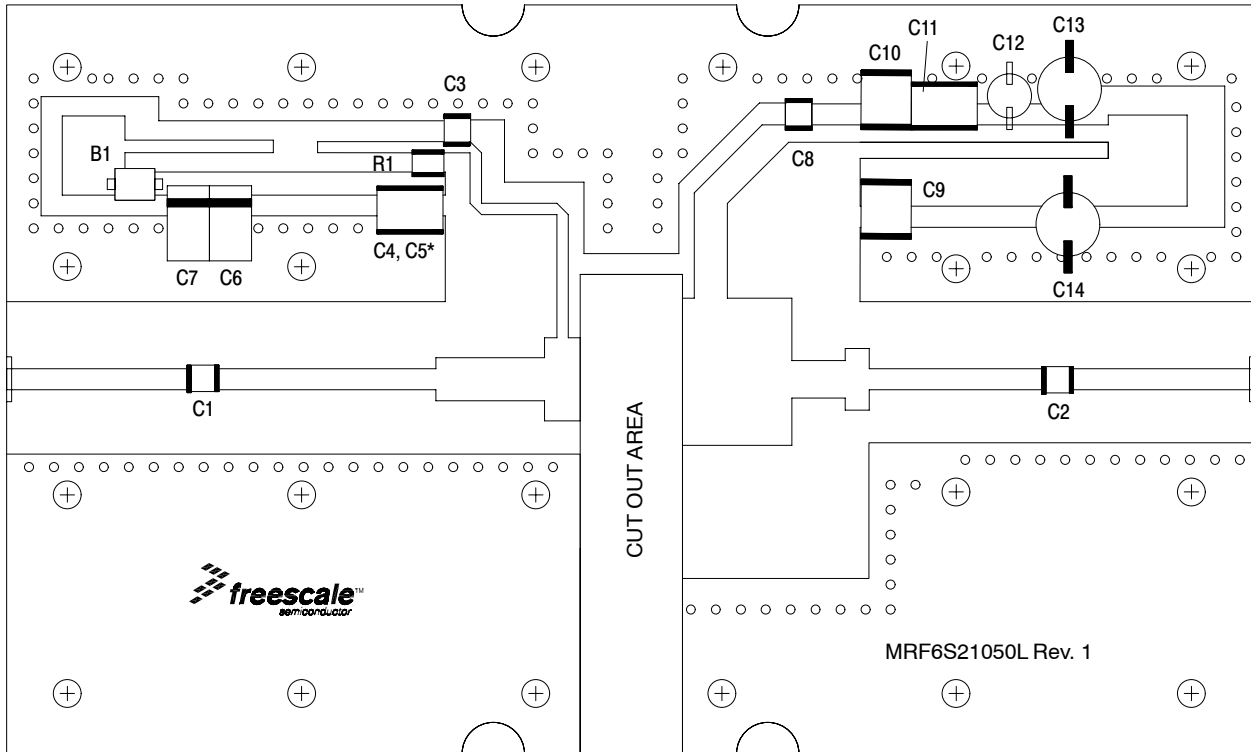

\* C4 on bottom, C5 on top.

**Figure 2. MRF6S21050LR3(LSR3) Test Circuit Component Layout**

## TYPICAL CHARACTERISTICS

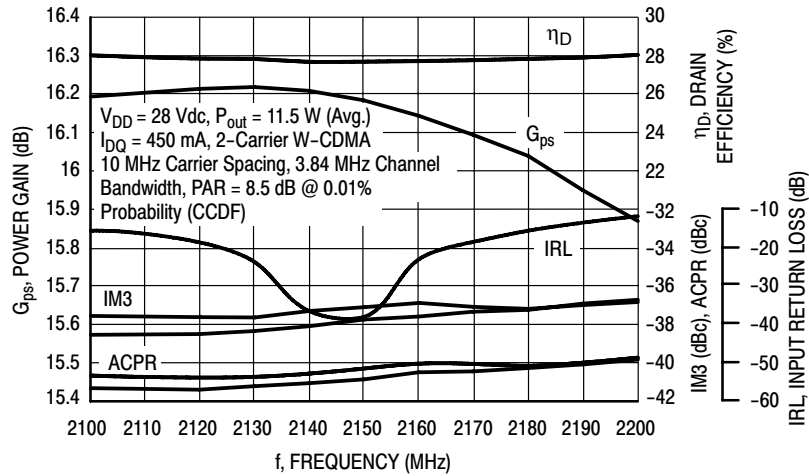

Figure 3. 2-Carrier W-CDMA Broadband Performance @  $P_{out} = 11.5$  Watts

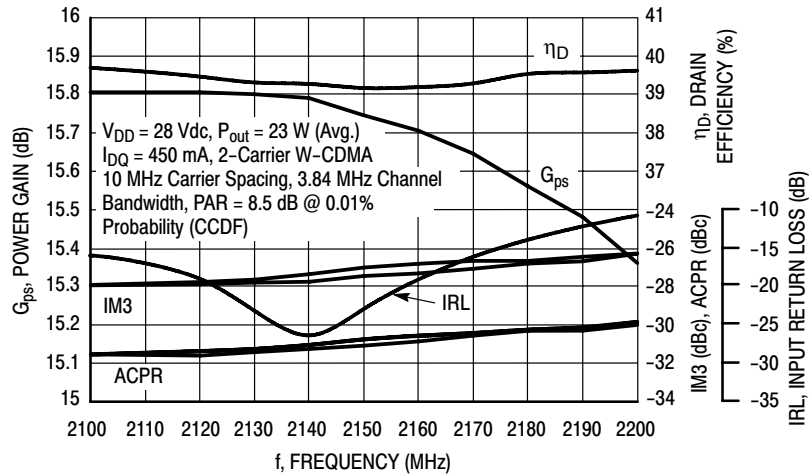

Figure 4. 2-Carrier W-CDMA Broadband Performance @  $P_{out} = 23$  Watts

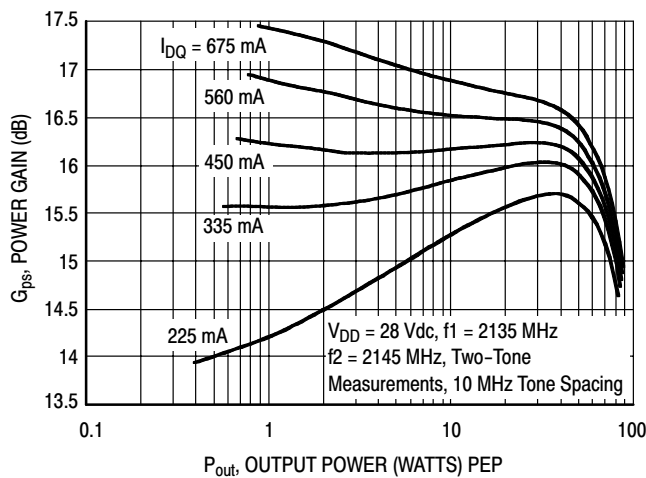

Figure 5. Two-Tone Power Gain versus Output Power

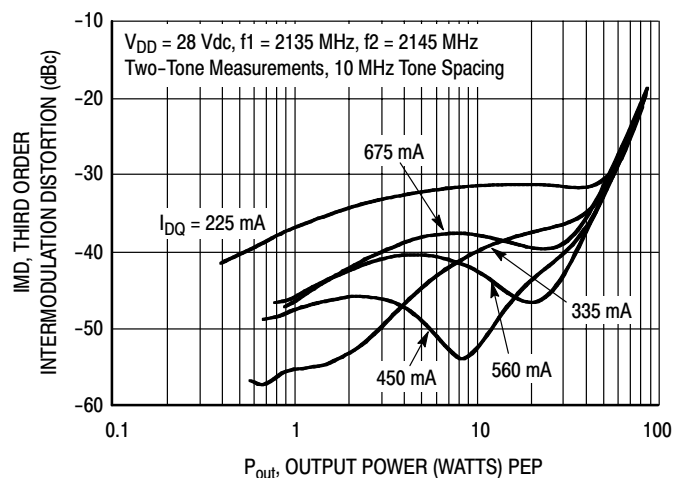
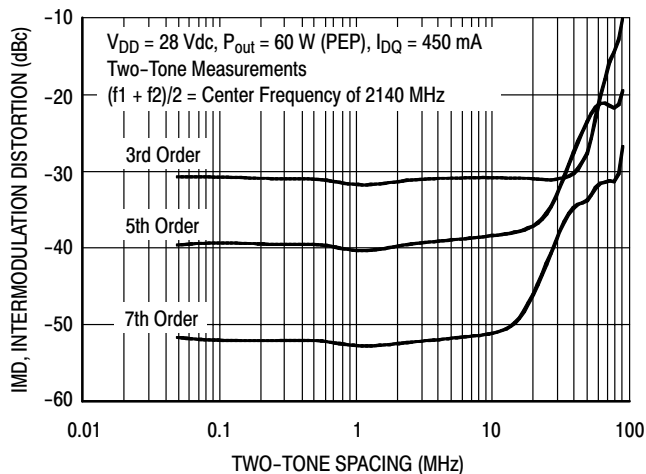

Figure 6. Third Order Intermodulation Distortion versus Output Power

MRF6S21050LR3 MRF6S21050LSR3

## TYPICAL CHARACTERISTICS



**Figure 7. Intermodulation Distortion Products versus Tone Spacing**

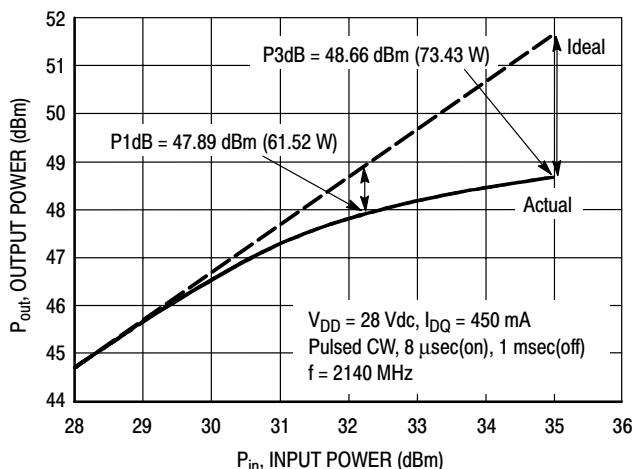

**Figure 8. Pulse CW Output Power versus Input Power**

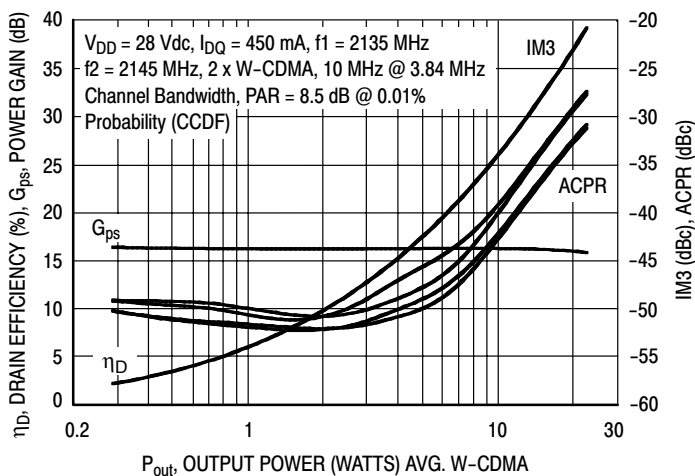

**Figure 9. 2-Carrier W-CDMA ACPR, IM3, Power Gain and Drain Efficiency versus Output Power**

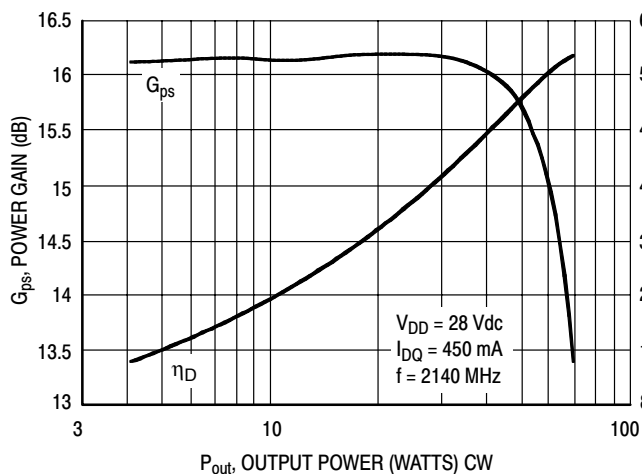

**Figure 10. Power Gain and Drain Efficiency versus CW Output Power**

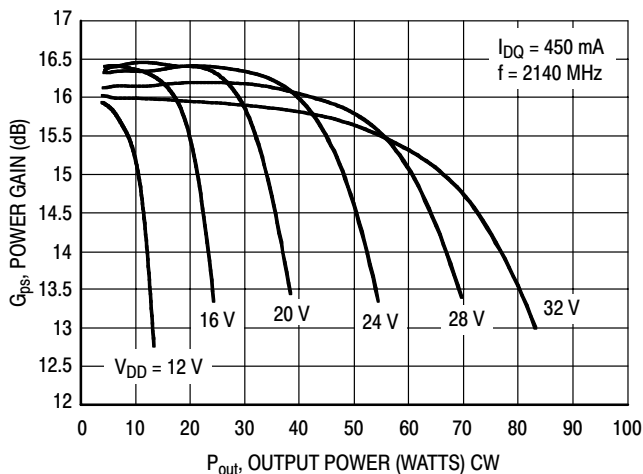

**Figure 11. Power Gain versus Output Power**

MRF6S21050LR3 MRF6S21050LSR3

## TYPICAL CHARACTERISTICS

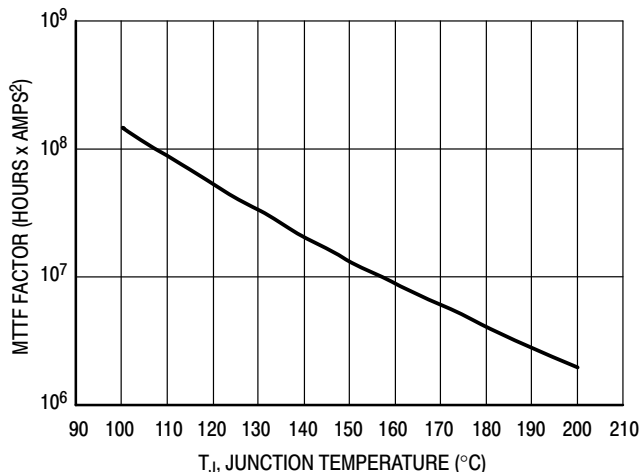

This above graph displays calculated MTTF in hours x ampere<sup>2</sup> drain current. Life tests at elevated temperatures have correlated to better than ±10% of the theoretical prediction for metal failure. Divide MTTF factor by  $I_D^2$  for MTTF in a particular application.

Figure 12. MTTF Factor versus Junction Temperature

## W-CDMA TEST SIGNAL

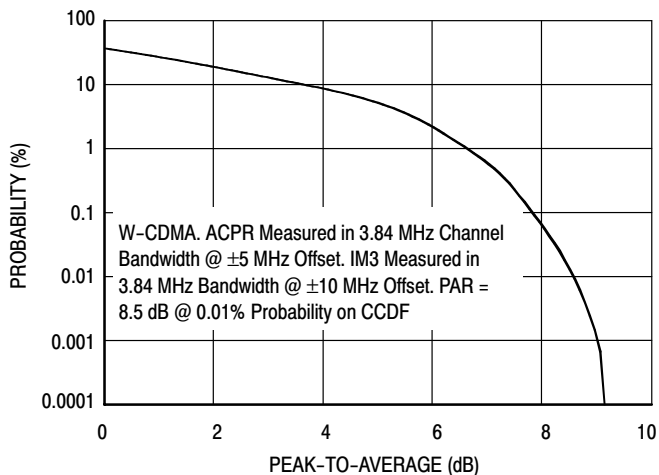

Figure 13. CCDF W-CDMA 3GPP, Test Model 1, 64 DPCH, 67% Clipping, Single-Carrier Test Signal

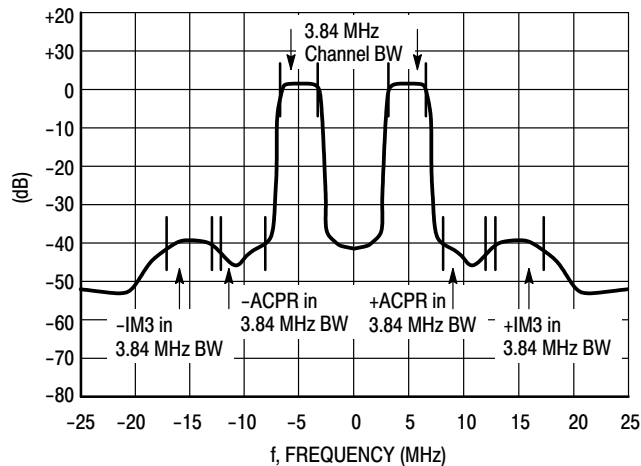
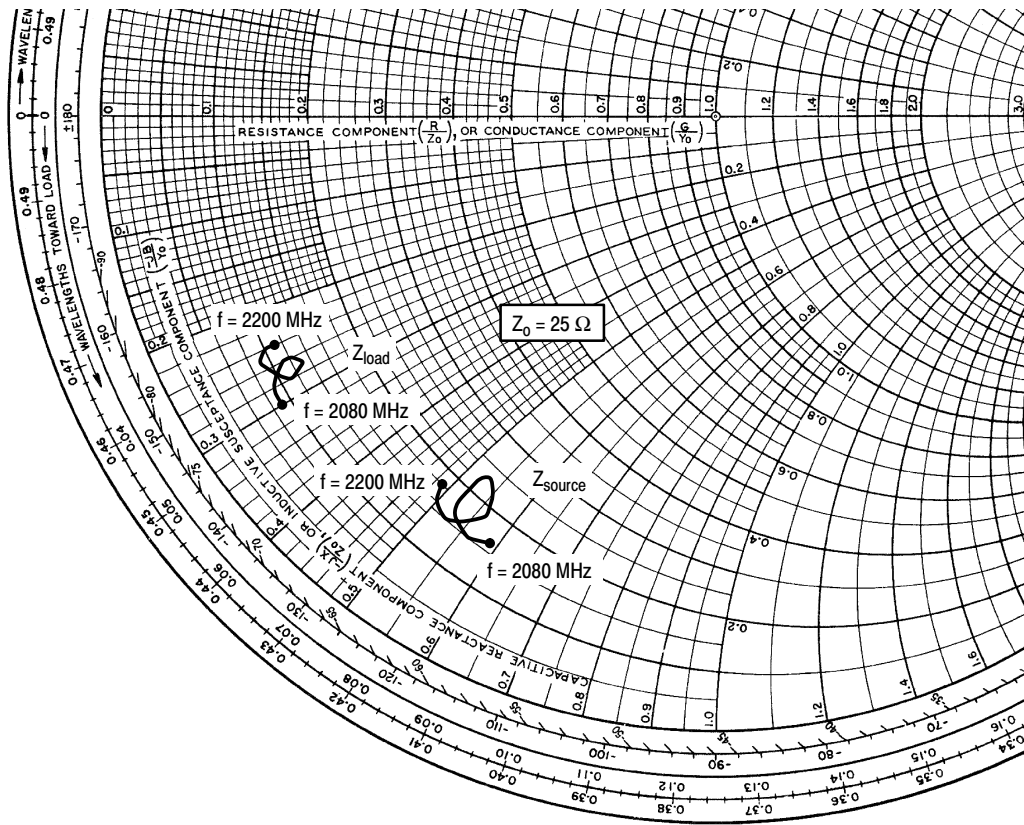

Figure 14. 2-Carrier W-CDMA Spectrum



$V_{DD} = 28 \text{ Vdc}$ ,  $I_{DQ} = 450 \text{ mA}$ ,  $P_{out} = 11.5 \text{ W Avg.}$

f MHz	$Z_{source}$ $\Omega$	$Z_{load}$ $\Omega$
2080	4.09 - j14.65	2.36 - j7.52
2090	3.74 - j13.95	2.25 - j7.11
2100	3.95 - j13.36	2.40 - j6.78
2110	4.44 - j13.00	2.68 - j6.59
2120	5.03 - j12.89	2.99 - j6.52
2130	5.55 - j13.05	3.26 - j6.64
2140	5.76 - j13.26	3.32 - j6.68
2150	5.57 - j13.70	3.20 - j6.87
2160	4.86 - j13.92	2.82 - j6.93
2170	4.04 - j13.61	2.44 - j6.70
2180	3.69 - j12.91	2.33 - j6.29
2190	3.91 - j12.44	2.49 - j6.05
2200	4.41 - j12.32	2.77 - j5.96

$Z_{source}$  = Test circuit impedance as measured from gate to ground.

$Z_{load}$  = Test circuit impedance as measured from drain to ground.

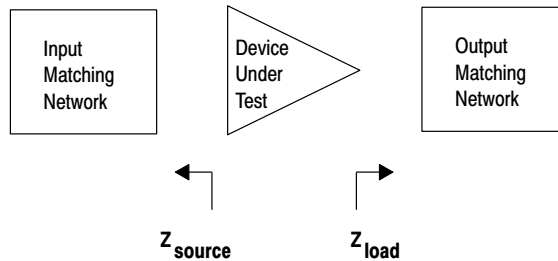

Figure 15. Series Equivalent Source and Load Impedance



# NOTES

# NOTES

## PACKAGE DIMENSIONS

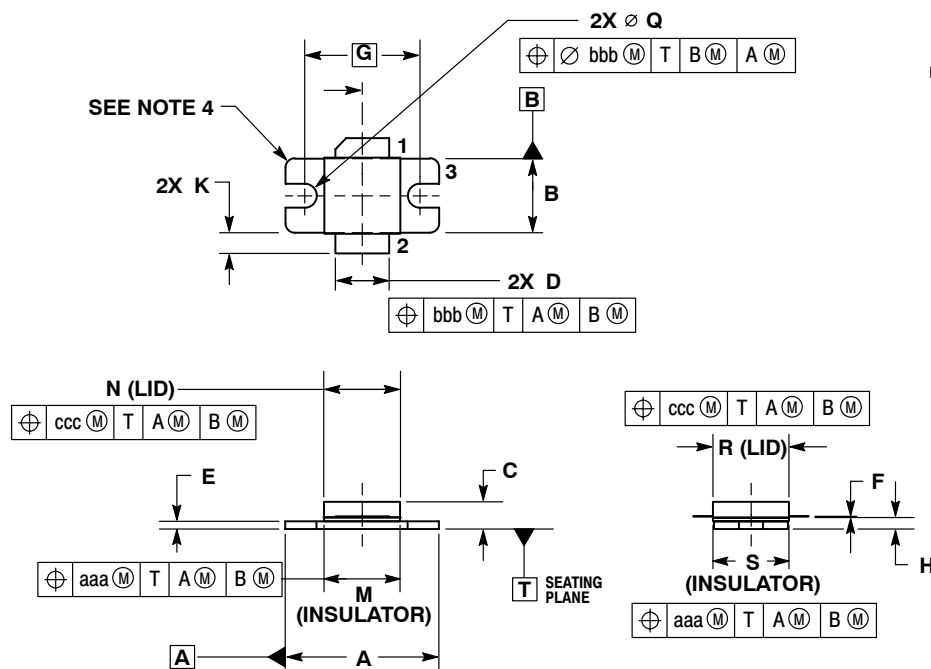

- NOTES:
1. CONTROLLING DIMENSION: INCH.
  2. INTERPRET DIMENSIONS AND TOLERANCES PER ASME Y14.5M, 1994.
  3. DIMENSION H IS MEASURED 0.030 (0.762) AWAY FROM PACKAGE BODY.
  4. INFORMATION ONLY: CORNER BREAK (4X) TO BE  $.060 \pm .005$  (1.52  $\pm$  0.13) RADIUS OR  $.06 \pm .005$  (1.52  $\pm$  0.13) x 45° CHAMFER.

DIM	INCHES		MILLIMETERS	
	MIN	MAX	MIN	MAX
A	.795	.805	20.19	20.44
B	.380	.390	9.65	9.9
C	.125	.163	3.17	4.14
D	.275	.285	6.98	7.24
E	.035	.045	0.89	1.14
F	.004	.006	0.10	0.15
G	.600 BSC		15.24 BSC	
H	.057	.067	1.45	1.7
K	.092	.122	2.33	3.1
M	.395	.405	10	10.3
N	.395	.405	10	10.3
Q	$\varnothing$ .120	$\varnothing$ .130	$\varnothing$ 3.05	$\varnothing$ 3.3
R	.395	.405	10	10.3
S	.395	.405	10	10.3
aaa	.005 BSC		0.127 BSC	
bbb	.010 BSC		0.254 BSC	
ccc	.015 BSC		0.381 BSC	

- STYLE 1:  
 PIN 1. DRAIN  
 2. GATE  
 3. SOURCE

**CASE 465E-04  
 ISSUE F  
 NI-400  
 MRF6S21050LR3**

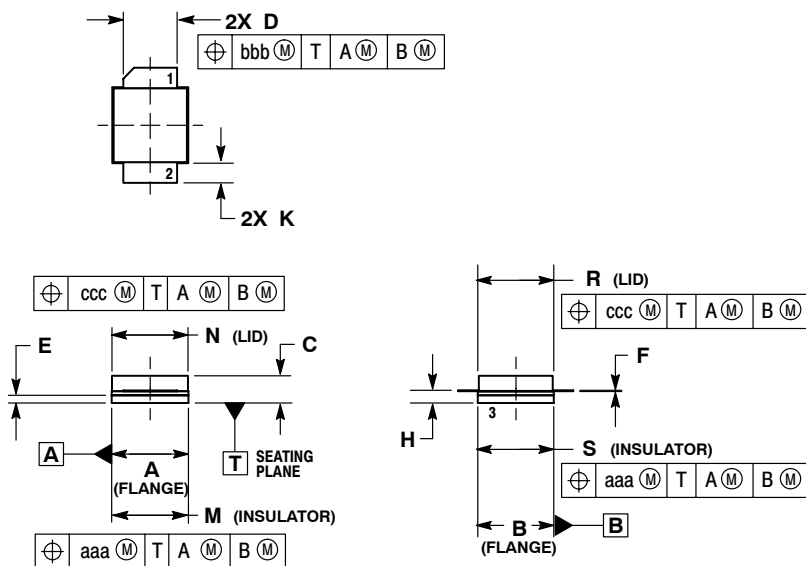

- NOTES:
1. CONTROLLING DIMENSION: INCH.
  2. INTERPRET DIMENSIONS AND TOLERANCES PER ASME Y14.5M-1994.
  3. DIMENSION H IS MEASURED 0.030 (0.762) AWAY FROM PACKAGE BODY.

DIM	INCHES		MILLIMETERS	
	MIN	MAX	MIN	MAX
A	.395	.405	10.03	10.29
B	.395	.405	10.03	10.29
C	.125	.163	3.18	4.14
D	.275	.285	6.98	7.24
E	.035	.045	0.89	1.14
F	.004	.006	0.10	0.15
H	.057	.067	1.45	1.70
K	.092	.122	2.34	3.10
M	.395	.405	10.03	10.29
N	.395	.405	10.03	10.29
R	.395	.405	10.03	10.29
S	.395	.405	10.03	10.29
aaa	.005 REF		0.127 REF	
bbb	.010 REF		0.254 REF	
ccc	.015 REF		0.38 REF	

- STYLE 1:  
 PIN 1. DRAIN  
 2. GATE  
 3. SOURCE

**CASE 465F-04  
 ISSUE E  
 NI-400S  
 MRF6S21050LSR3**

**MRF6S21050LR3 MRF6S21050LSR3**

## **How to Reach Us:**

### **Home Page:**

www.freescale.com

### **E-mail:**

support@freescale.com

### **USA/Europe or Locations Not Listed:**

Freescale Semiconductor  
Technical Information Center, CH370  
1300 N. Alma School Road  
Chandler, Arizona 85224  
+1-800-521-6274 or +1-480-768-2130  
support@freescale.com

### **Europe, Middle East, and Africa:**

Freescale Halbleiter Deutschland GmbH  
Technical Information Center  
Schatzbogen 7  
81829 Muenchen, Germany  
+44 1296 380 456 (English)  
+46 8 52200080 (English)  
+49 89 92103 559 (German)  
+33 1 69 35 48 48 (French)  
support@freescale.com

### **Japan:**

Freescale Semiconductor Japan Ltd.  
Headquarters  
ARCO Tower 15F  
1-8-1, Shimo-Meguro, Meguro-ku,  
Tokyo 153-0064  
Japan  
0120 191014 or +81 3 5437 9125  
support.japan@freescale.com

### **Asia/Pacific:**

Freescale Semiconductor Hong Kong Ltd.  
Technical Information Center  
2 Dai King Street  
Tai Po Industrial Estate  
Tai Po, N.T., Hong Kong  
+800 2666 8080  
support.asia@freescale.com

### **For Literature Requests Only:**

Freescale Semiconductor Literature Distribution Center  
P.O. Box 5405  
Denver, Colorado 80217  
1-800-441-2447 or 303-675-2140  
Fax: 303-675-2150  
LDCForFreescaleSemiconductor@hibbertgroup.com

Information in this document is provided solely to enable system and software implementers to use Freescale Semiconductor products. There are no express or implied copyright licenses granted hereunder to design or fabricate any integrated circuits or integrated circuits based on the information in this document.

Freescale Semiconductor reserves the right to make changes without further notice to any products herein. Freescale Semiconductor makes no warranty, representation or guarantee regarding the suitability of its products for any particular purpose, nor does Freescale Semiconductor assume any liability arising out of the application or use of any product or circuit, and specifically disclaims any and all liability, including without limitation consequential or incidental damages. "Typical" parameters that may be provided in Freescale Semiconductor data sheets and/or specifications can and do vary in different applications and actual performance may vary over time. All operating parameters, including "Typicals", must be validated for each customer application by customer's technical experts. Freescale Semiconductor does not convey any license under its patent rights nor the rights of others. Freescale Semiconductor products are not designed, intended, or authorized for use as components in systems intended for surgical implant into the body, or other applications intended to support or sustain life, or for any other application in which the failure of the Freescale Semiconductor product could create a situation where personal injury or death may occur. Should Buyer purchase or use Freescale Semiconductor products for any such unintended or unauthorized application, Buyer shall indemnify and hold Freescale Semiconductor and its officers, employees, subsidiaries, affiliates, and distributors harmless against all claims, costs, damages, and expenses, and reasonable attorney fees arising out of, directly or indirectly, any claim of personal injury or death associated with such unintended or unauthorized use, even if such claim alleges that Freescale Semiconductor was negligent regarding the design or manufacture of the part.

Freescale™ and the Freescale logo are trademarks of Freescale Semiconductor, Inc. All other product or service names are the property of their respective owners.

© Freescale Semiconductor, Inc. 2006. All rights reserved.

