

RF Power Field Effect Transistors

N-Channel Enhancement-Mode Lateral MOSFETs

Designed for N-CDMA base station applications with frequencies from 1930 to 1990 MHz. Suitable for TDMA, CDMA and multicarrier amplifier applications. To be used in Class AB for PCN - PCS/cellular radio and WLL applications.

- Typical 2-Carrier N-CDMA Performance: $V_{DD} = 28$ Volts, $I_{DQ} = 950$ mA, $P_{out} = 22$ Watts Avg., Full Frequency Band, IS-95 CDMA (Pilot, Sync, Paging, Traffic Codes 8 Through 13) Channel Bandwidth = 1.2288 MHz. PAR = 9.8 dB @ 0.01% Probability on CCDF.
 - Power Gain — 14.5 dB
 - Drain Efficiency — 25.5%
 - IM3 @ 2.5 MHz Offset — -37 dBc in 1.2288 MHz Bandwidth
 - ACPR @ 885 kHz Offset — -51 dBc in 30 kHz Bandwidth
- Capable of Handling 5:1 VSWR, @ 28 Vdc, 1960 MHz, 100 Watts CW Output Power

Features

- Characterized with Series Equivalent Large-Signal Impedance Parameters
- Internally Matched for Ease of Use
- Qualified Up to a Maximum of 32 V_{DD} Operation
- Integrated ESD Protection
- N Suffix Indicates Lead-Free Terminations
- Designed for Lower Memory Effects and Wide Instantaneous Bandwidth Applications
- 200°C Capable Plastic Package
- RoHS Compliant
- In Tape and Reel. R1 Suffix = 500 Units per 44 mm, 13 inch Reel.

MRF6S19100NR1
MRF6S19100NBR1

1930-1990 MHz, 22 W AVG., 28 V
2 x N-CDMA
LATERAL N-CHANNEL
RF POWER MOSFETs

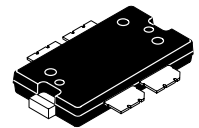

CASE 1486-03, STYLE 1
TO-270 WB-4
PLASTIC
MRF6S19100NR1

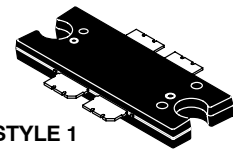

CASE 1484-04, STYLE 1
TO-272 WB-4
PLASTIC
MRF6S19100NBR1

Table 1. Maximum Ratings

Rating	Symbol	Value	Unit
Drain-Source Voltage	V_{DSS}	-0.5, +68	Vdc
Gate-Source Voltage	V_{GS}	-0.5, +12	Vdc
Total Device Dissipation @ $T_C = 25^\circ\text{C}$ Derate above 25°C	P_D	287 1.64	W W/°C
Storage Temperature Range	T_{stg}	- 65 to +175	°C
Operating Junction Temperature	T_J	200	°C

Table 2. Thermal Characteristics

Characteristic	Symbol	Value (1,2)	Unit
Thermal Resistance, Junction to Case Case Temperature 80°C, 100 W CW Case Temperature 75°C, 23 W CW	$R_{\theta JC}$	0.61 0.65	°C/W

1. MTF calculator available at <http://www.freescale.com/rf>. Select Tools/Software/Application Software/Calculators to access the MTF calculators by product.
2. Refer to AN1955, *Thermal Measurement Methodology of RF Power Amplifiers*. Go to <http://www.freescale.com/rf>. Select Documentation/Application Notes - AN1955.

Table 3. ESD Protection Characteristics

Test Methodology	Class
Human Body Model (per JESD22-A114)	1B (Minimum)
Machine Model (per EIA/JESD22-A115)	A (Minimum)
Charge Device Model (per JESD22-C101)	IV (Minimum)

Table 4. Moisture Sensitivity Level

Test Methodology	Rating	Package Peak Temperature	Unit
Per JESD 22-A113, IPC/JEDEC J-STD-020	3	260	°C

Table 5. Electrical Characteristics ($T_C = 25^\circ\text{C}$ unless otherwise noted)

Characteristic	Symbol	Min	Typ	Max	Unit
----------------	--------	-----	-----	-----	------

Off Characteristics

Zero Gate Voltage Drain Leakage Current ($V_{DS} = 68\text{ Vdc}$, $V_{GS} = 0\text{ Vdc}$)	I_{DSS}	—	—	10	μAdc
Zero Gate Voltage Drain Leakage Current ($V_{DS} = 28\text{ Vdc}$, $V_{GS} = 0\text{ Vdc}$)	I_{DSS}	—	—	1	μAdc
Gate-Source Leakage Current ($V_{GS} = 5\text{ Vdc}$, $V_{DS} = 0\text{ Vdc}$)	I_{GSS}	—	—	1	μAdc

On Characteristics

Gate Threshold Voltage ($V_{DS} = 10\text{ Vdc}$, $I_D = 330\ \mu\text{Adc}$)	$V_{GS(th)}$	1	2	3	Vdc
Gate Quiescent Voltage ($V_{DS} = 28\text{ Vdc}$, $I_D = 950\ \text{mAdc}$)	$V_{GS(Q)}$	2	2.8	4	Vdc
Drain-Source On-Voltage ($V_{GS} = 10\text{ Vdc}$, $I_D = 3.3\ \text{Adc}$)	$V_{DS(on)}$	—	0.24	—	Vdc
Forward Transconductance ($V_{DS} = 10\text{ Vdc}$, $I_D = 2.2\ \text{Adc}$)	g_{fs}	—	5.3	—	S

Dynamic Characteristics ⁽¹⁾

Reverse Transfer Capacitance ($V_{DS} = 28\text{ Vdc} \pm 30\ \text{mV(rms)ac}$ @ 1 MHz, $V_{GS} = 0\text{ Vdc}$)	C_{rss}	—	1.5	—	pF
--	-----------	---	-----	---	----

Functional Tests (In Freescale Test Fixture, 50 ohm system) $V_{DD} = 28\text{ Vdc}$, $I_{DQ} = 950\ \text{mA}$, $P_{out} = 22\ \text{W Avg.}$, $f_1 = 1930\ \text{MHz}$, $f_2 = 1932.5\ \text{MHz}$ and $f_1 = 1987.5\ \text{MHz}$, $f_2 = 1990\ \text{MHz}$, 2-Carrier N-CDMA, 1.2288 MHz Channel Bandwidth Carriers. ACPR measured in 30 kHz Channel Bandwidth @ $\pm 885\ \text{kHz}$ Offset. IM3 measured in 1.2288 MHz Channel Bandwidth @ $\pm 2.5\ \text{MHz}$ Offset. PAR = 9.8 dB @ 0.01% Probability on CCDF.

Power Gain	G_{ps}	13	14.5	16	dB
Drain Efficiency	η_D	24	25.5	36	%
Intermodulation Distortion	IM3	-47	-37	-35	dBc
Adjacent Channel Power Ratio	ACPR	-60	-51	-48	dBc
Input Return Loss	IRL	—	-12	-10	dB

1. Part is internally matched both on input and output.

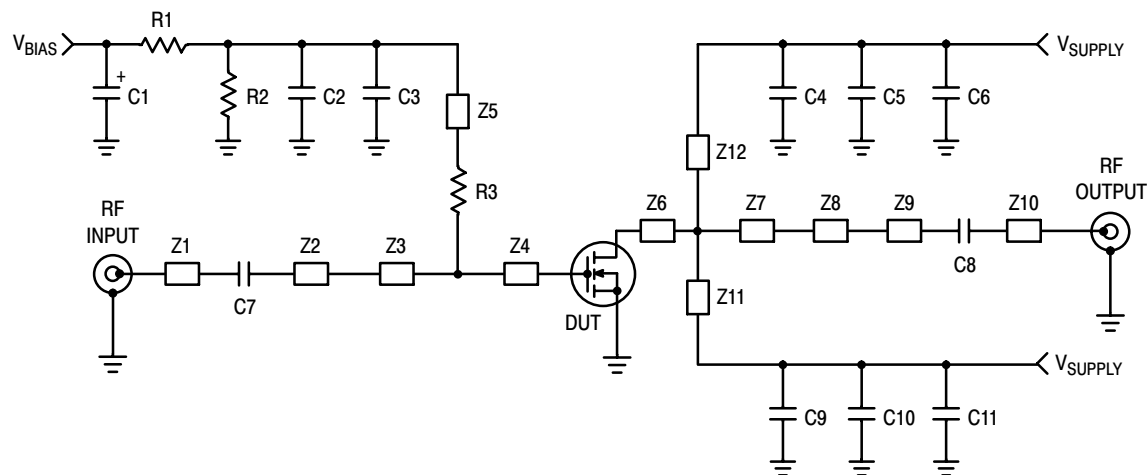

Z1, Z10 0.743" x 0.084" Microstrip
 Z2 0.818" x 0.084" Microstrip
 Z3 0.165" x 0.386" Microstrip
 Z4 0.505" x 0.800" Microstrip
 Z5 0.323" x 0.040" Microstrip
 Z6 0.160" x 0.880" Microstrip

Z7 0.319" x 0.880" Microstrip
 Z8 0.355" x 0.215" Microstrip
 Z9 0.661" x 0.084" Microstrip
 Z11, Z12 1.328" x 0.120" Microstrip
 PCB Arlon AD250, 0.030", $\epsilon_r = 2.5$

Figure 1. MRF6S19100NR1(NBR1) Test Circuit Schematic

Table 6. MRF6S19100NR1(NBR1) Test Circuit Component Designations and Values

Part	Description	Part Number	Manufacturer
C1	10 μ F, 35 V Tantalum Capacitor	T491D106K035AS	Kemet
C2	100 nF Chip Capacitor (1206)		
C3, C7	5.1 pF 600B Chip Capacitors	600B5R1BT250XT	ATC
C4, C8, C9	9.1 pF 600B Chip Capacitors	600B9R1BT250XT	ATC
C5, C6, C10, C11	10 μ F, 50 V Chip Capacitors	GRM55DR61H106KA88L	Murata
R1	1 k Ω , 1/4 W Chip Resistor (1206)		
R2	10 k Ω , 1/4 W Chip Resistor (1206)		
R3	10 Ω , 1/4 W Chip Resistor (1206)		

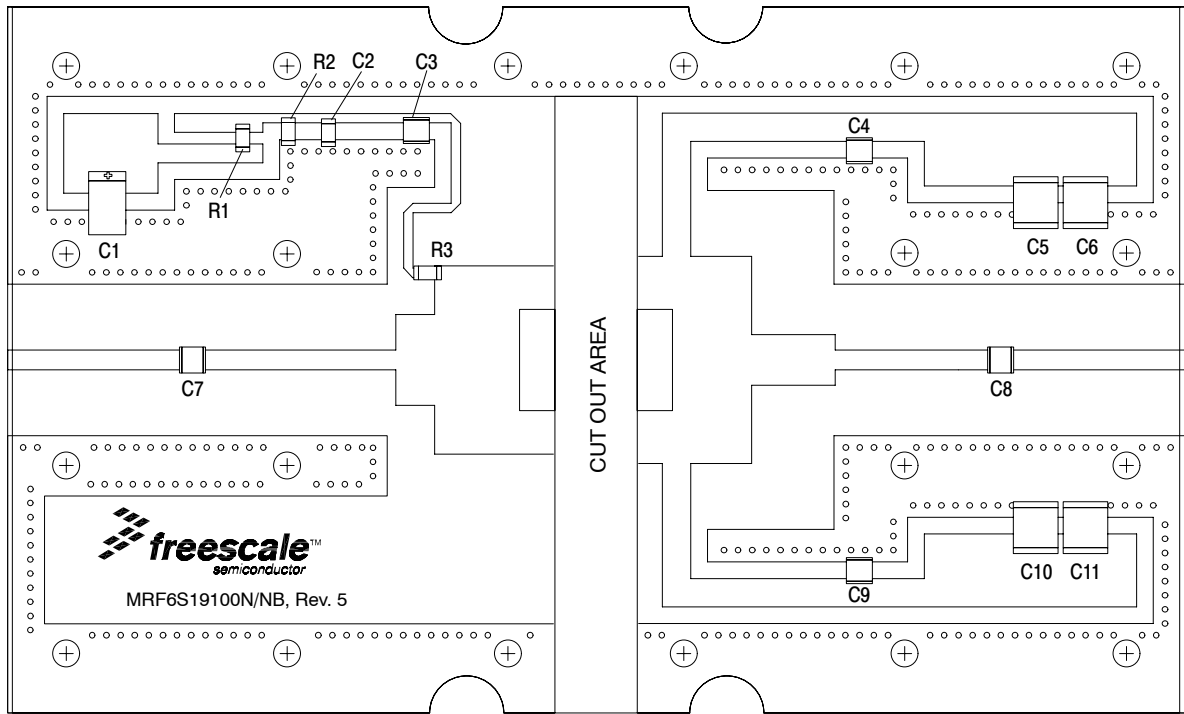

Figure 2. MRF6S19100NR1(NBR1) Test Circuit Component Layout

TYPICAL CHARACTERISTICS

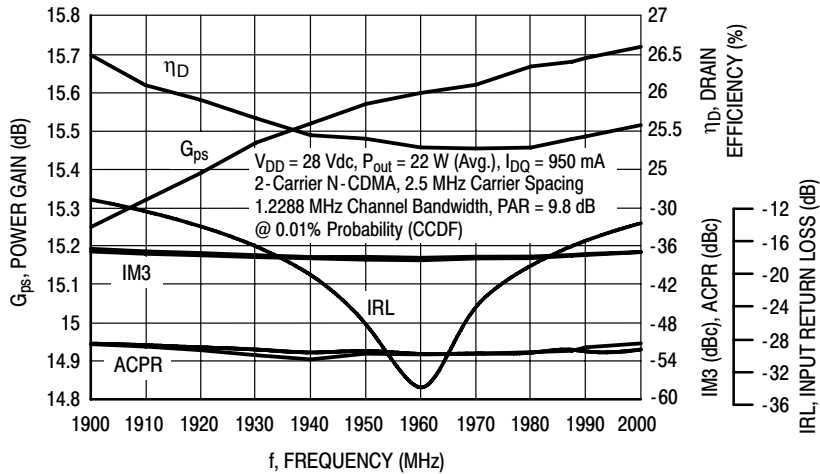

Figure 3. 2-Carrier N-CDMA Broadband Performance @ $P_{out} = 22$ Watts Avg.

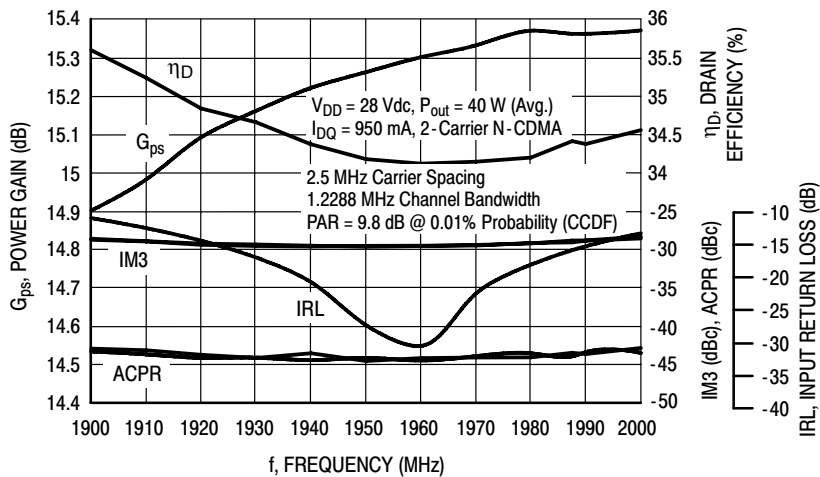

Figure 4. 2-Carrier N-CDMA Broadband Performance @ $P_{out} = 40$ Watts Avg.

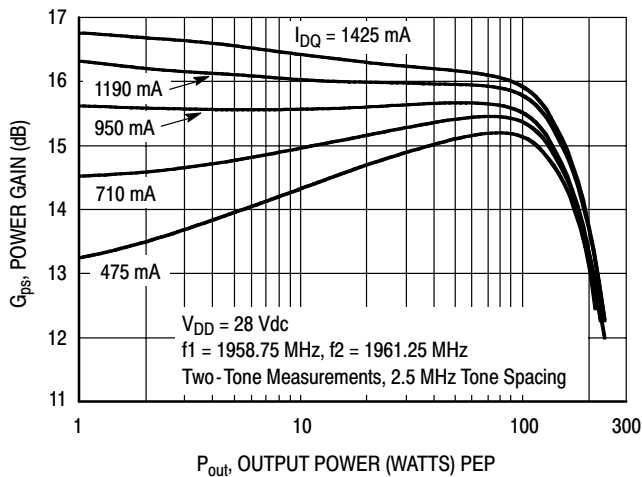

Figure 5. Two-Tone Power Gain versus Output Power

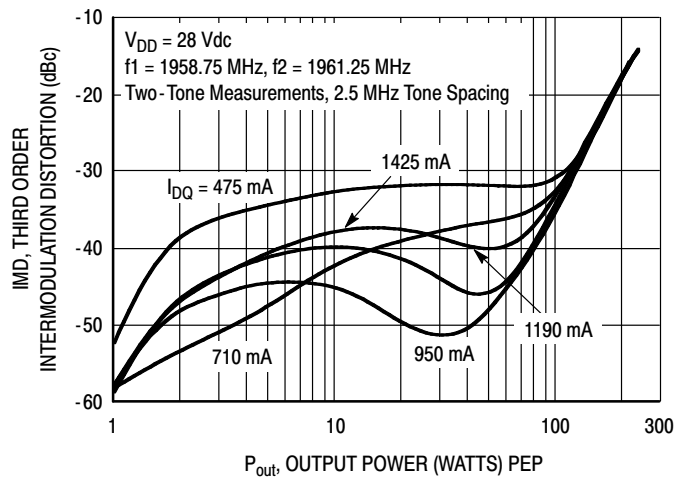

Figure 6. Third Order Intermodulation Distortion versus Output Power

TYPICAL CHARACTERISTICS

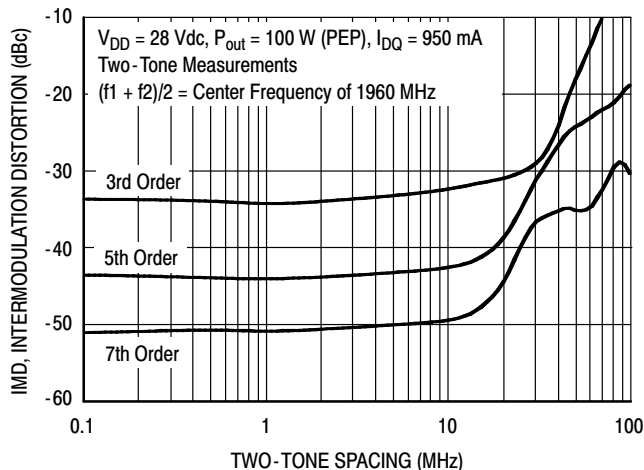

Figure 7. Intermodulation Distortion Products versus Tone Spacing

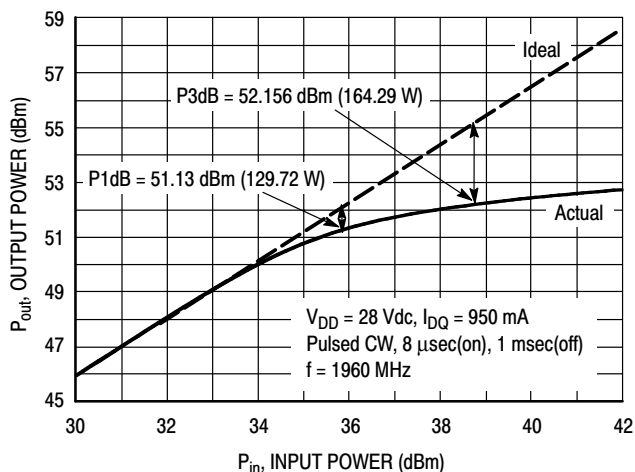

Figure 8. Pulse CW Output Power versus Input Power

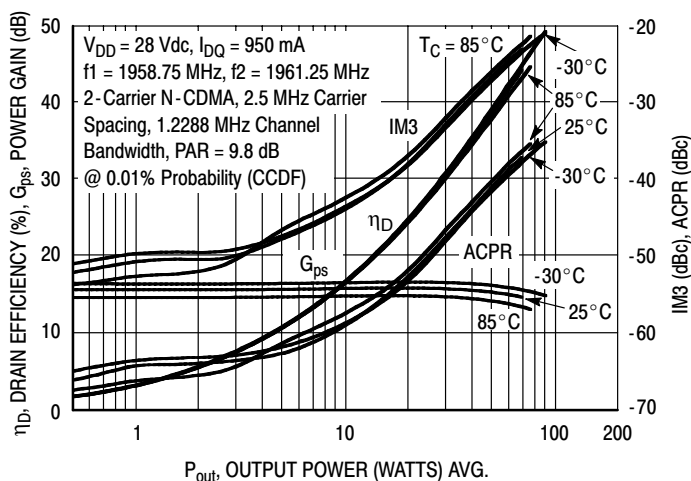

Figure 9. 2-Carrier N-CDMA ACPR, IM3, Power Gain and Drain Efficiency versus Output Power

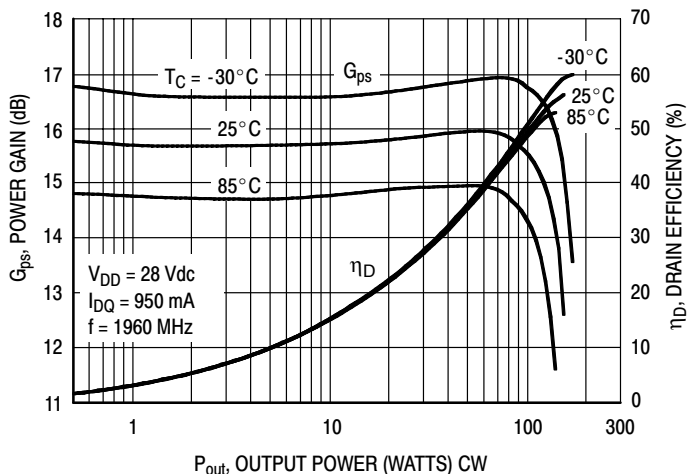

Figure 10. Power Gain and Drain Efficiency versus CW Output Power

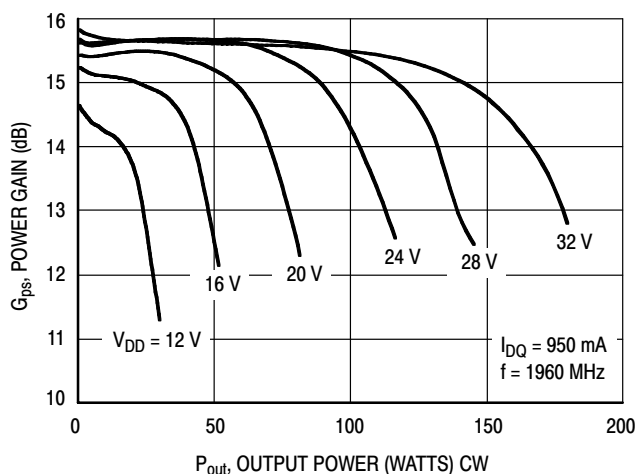
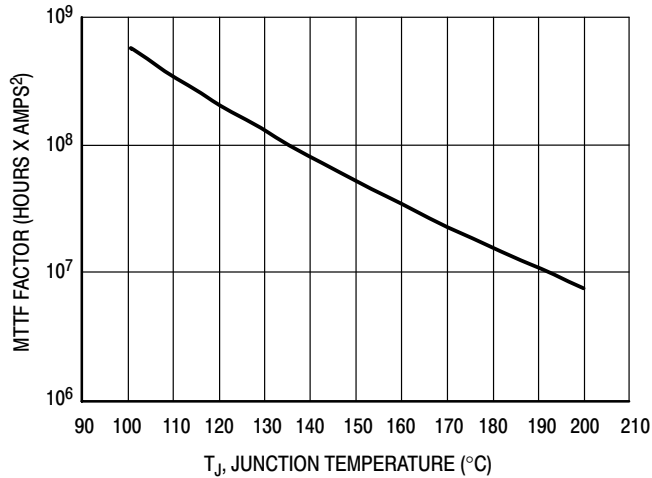

Figure 11. Power Gain versus Output Power

TYPICAL CHARACTERISTICS



This above graph displays calculated MTTF in hours x ampere² drain current. Life tests at elevated temperatures have correlated to better than $\pm 10\%$ of the theoretical prediction for metal failure. Divide MTTF factor by I_D^2 for MTTF in a particular application.

Figure 12. MTTF Factor versus Junction Temperature

N-CDMA TEST SIGNAL

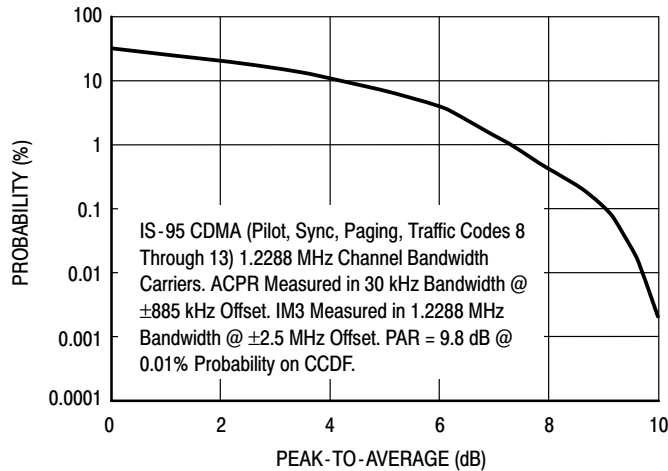

Figure 13. 2-Carrier CCDF N-CDMA

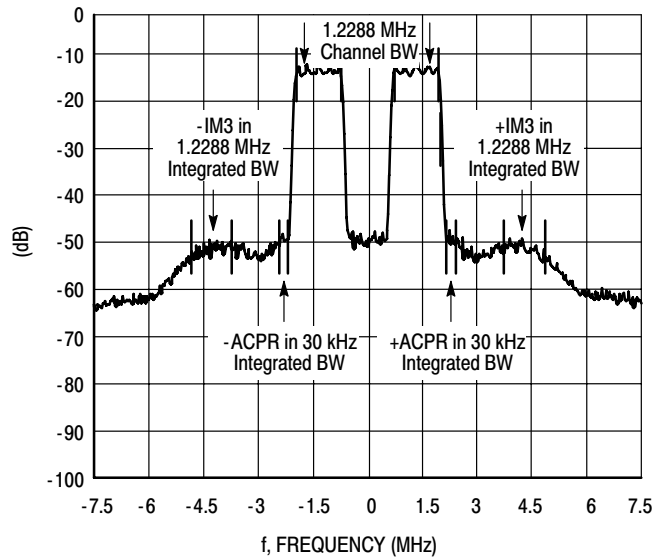
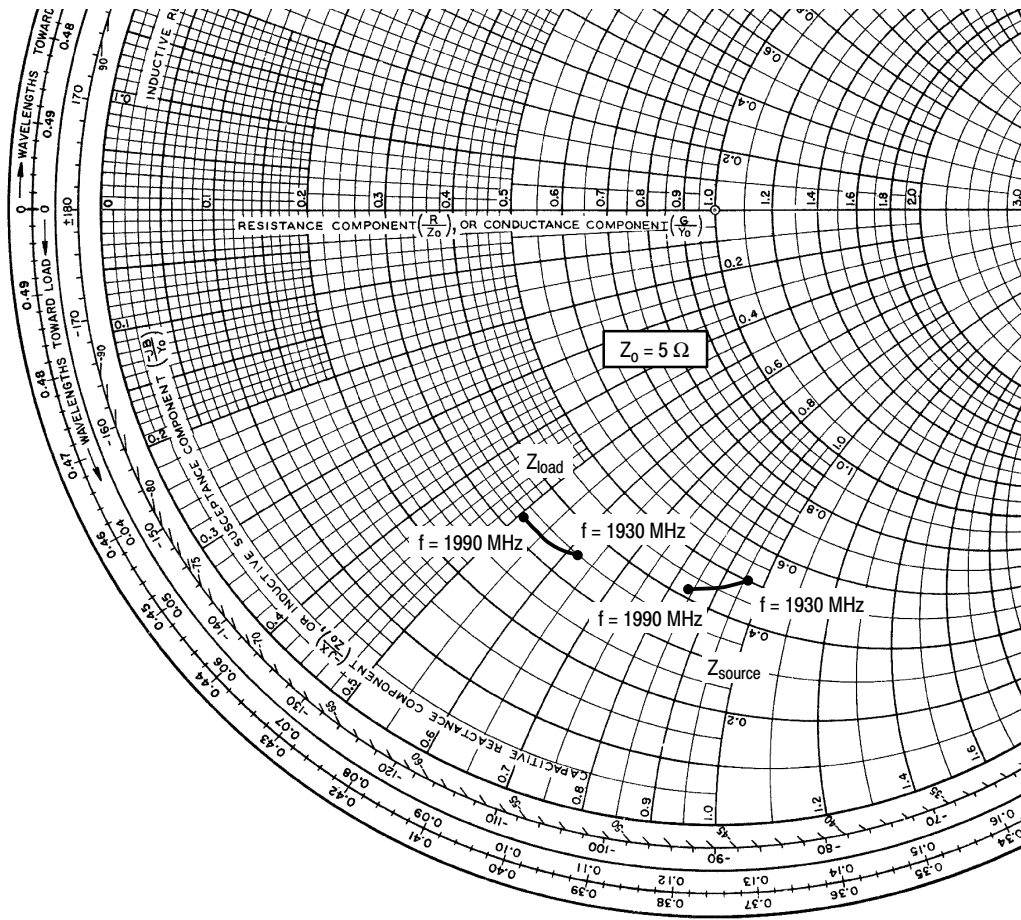

Figure 14. 2-Carrier N-CDMA Spectrum



$V_{DD} = 28 \text{ Vdc}$, $I_{DQ} = 950 \text{ mA}$, $P_{out} = 22 \text{ W Avg.}$

f MHz	Z_{source} Ω	Z_{load} Ω
1930	$2.51 - j4.80$	$1.74 - j3.11$
1960	$2.31 - j4.54$	$1.67 - j2.85$
1990	$2.12 - j4.20$	$1.63 - j2.55$

Z_{source} = Test circuit impedance as measured from gate to ground.

Z_{load} = Test circuit impedance as measured from drain to ground.

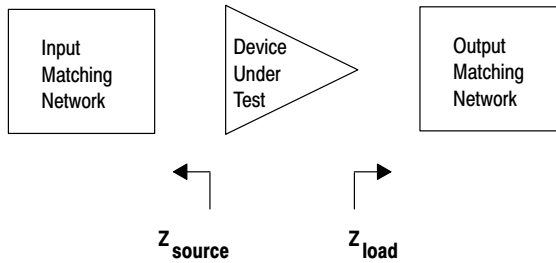

Figure 15. Series Equivalent Source and Load Impedance

NOTES

NOTES

NOTES

PACKAGE DIMENSIONS

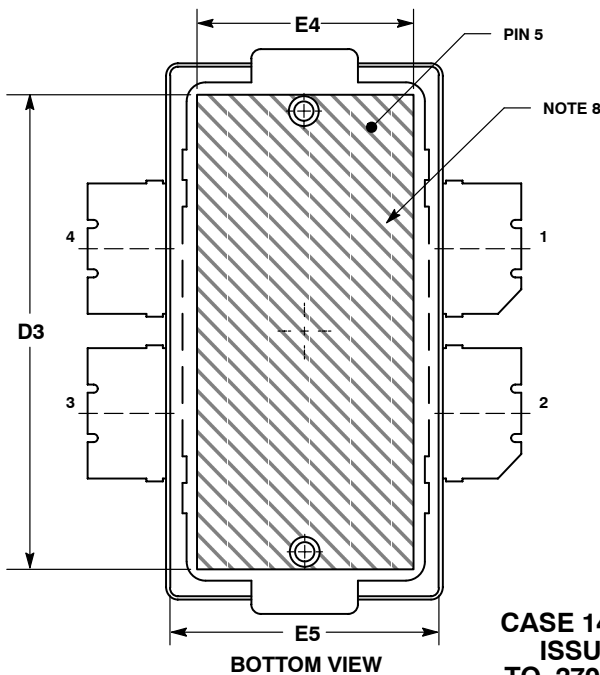
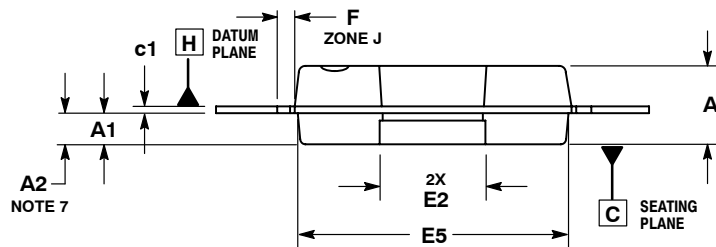
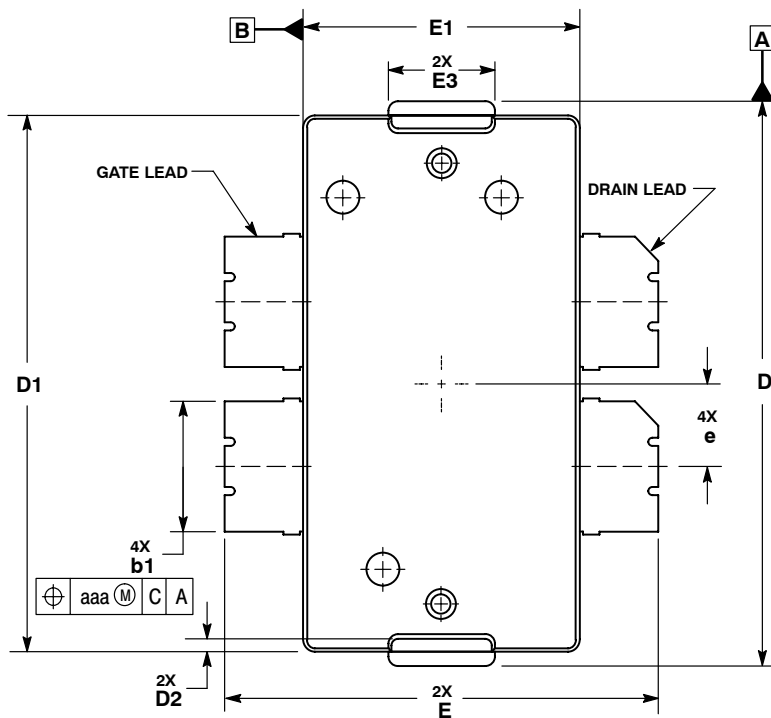

**CASE 1486-03
ISSUE C
TO-270 WB-4
PLASTIC
MRF6S19100NR1**

NOTES:

1. CONTROLLING DIMENSION: INCH.
2. INTERPRET DIMENSIONS AND TOLERANCES PER ASME Y14.5M-1994.
3. DATUM PLANE -H- IS LOCATED AT THE TOP OF LEAD AND IS COINCIDENT WITH THE LEAD WHERE THE LEAD EXITS THE PLASTIC BODY AT THE TOP OF THE PARTING LINE.
4. DIMENSIONS "D" AND "E1" DO NOT INCLUDE MOLD PROTRUSION. ALLOWABLE PROTRUSION IS .006 PER SIDE. DIMENSIONS "D" AND "E1" DO INCLUDE MOLD MISMATCH AND ARE DETERMINED AT DATUM PLANE -H-.
5. DIMENSION "b1" DOES NOT INCLUDE DAMBAR PROTRUSION. ALLOWABLE DAMBAR PROTRUSION SHALL BE .005 TOTAL IN EXCESS OF THE "b1" DIMENSION AT MAXIMUM MATERIAL CONDITION.
6. DATUMS -A- AND -B- TO BE DETERMINED AT DATUM PLANE -H-.
7. DIMENSION A2 APPLIES WITHIN ZONE "J" ONLY.
8. HATCHING REPRESENTS THE EXPOSED AREA OF THE HEAT SLUG.

DIM	INCHES		MILLIMETERS	
	MIN	MAX	MIN	MAX
A	.100	.104	2.54	2.64
A1	.039	.043	0.99	1.09
A2	.040	.042	1.02	1.07
D	.712	.720	18.08	18.29
D1	.688	.692	17.48	17.58
D2	.011	.019	0.28	0.48
D3	.600	---	15.24	---
E	.551	.559	14	14.2
E1	.353	.357	8.97	9.07
E2	.132	.140	3.35	3.56
E3	.124	.132	3.15	3.35
E4	.270	---	6.86	---
E5	.346	.350	8.79	8.89
F	.025 BSC		0.64 BSC	
b1	.164	.170	4.17	4.32
c1	.007	.011	0.18	0.28
e	.106 BSC		2.69 BSC	
aaa	.004		0.10	

STYLE 1:

- PIN 1. DRAIN
- DRAIN
- GATE
- GATE
- SOURCE

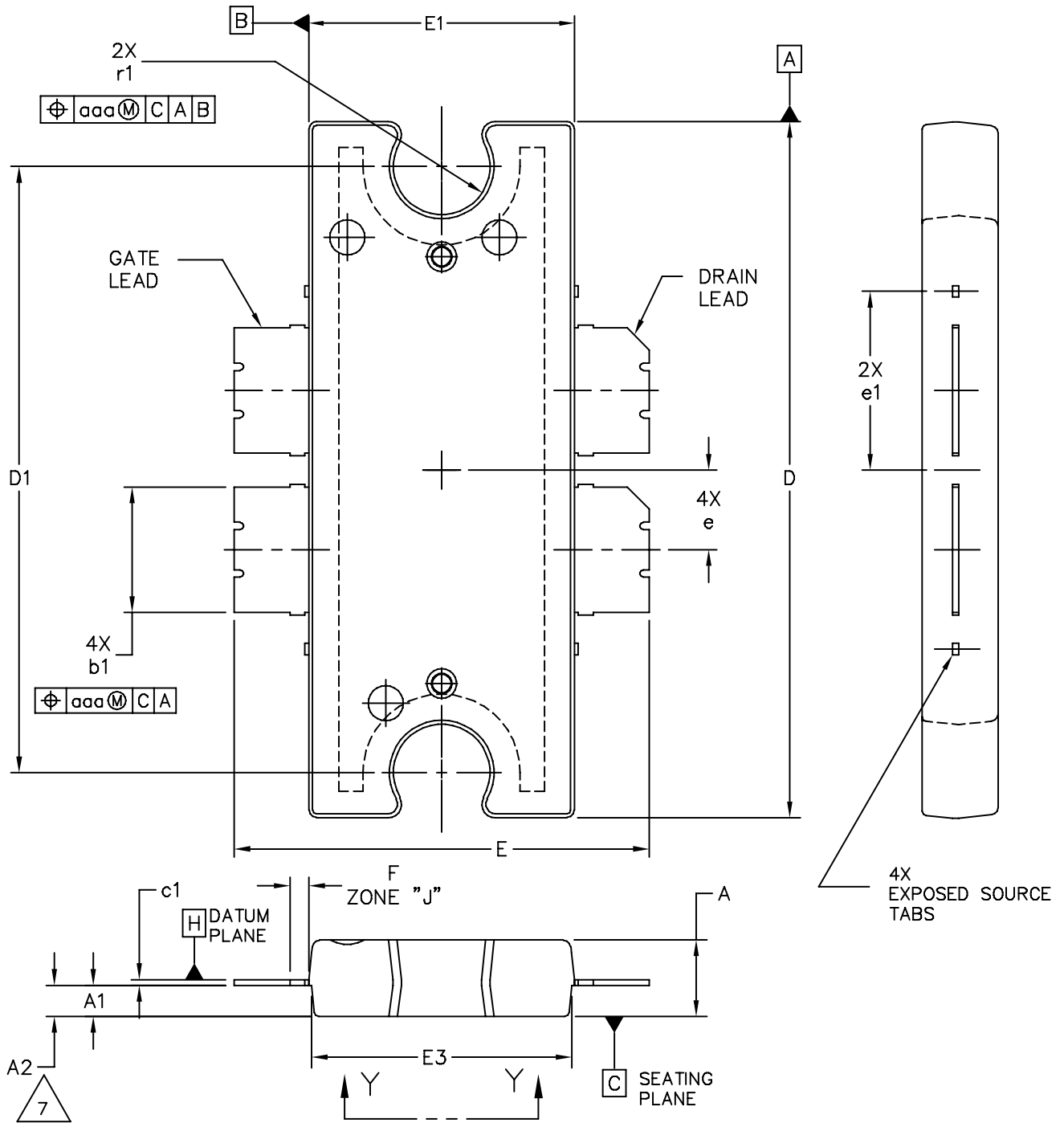

© FREESCALE SEMICONDUCTOR, INC. ALL RIGHTS RESERVED.		MECHANICAL OUTLINE		PRINT VERSION NOT TO SCALE	
TITLE: TO-272 4 LEAD, WIDE BODY			DOCUMENT NO: 98ASA10575D		REV: D
			CASE NUMBER: 1484-04		05 APR 2006
			STANDARD: NON-JEDEC		

MRF6S19100NR1 MRF6S19100NBR1

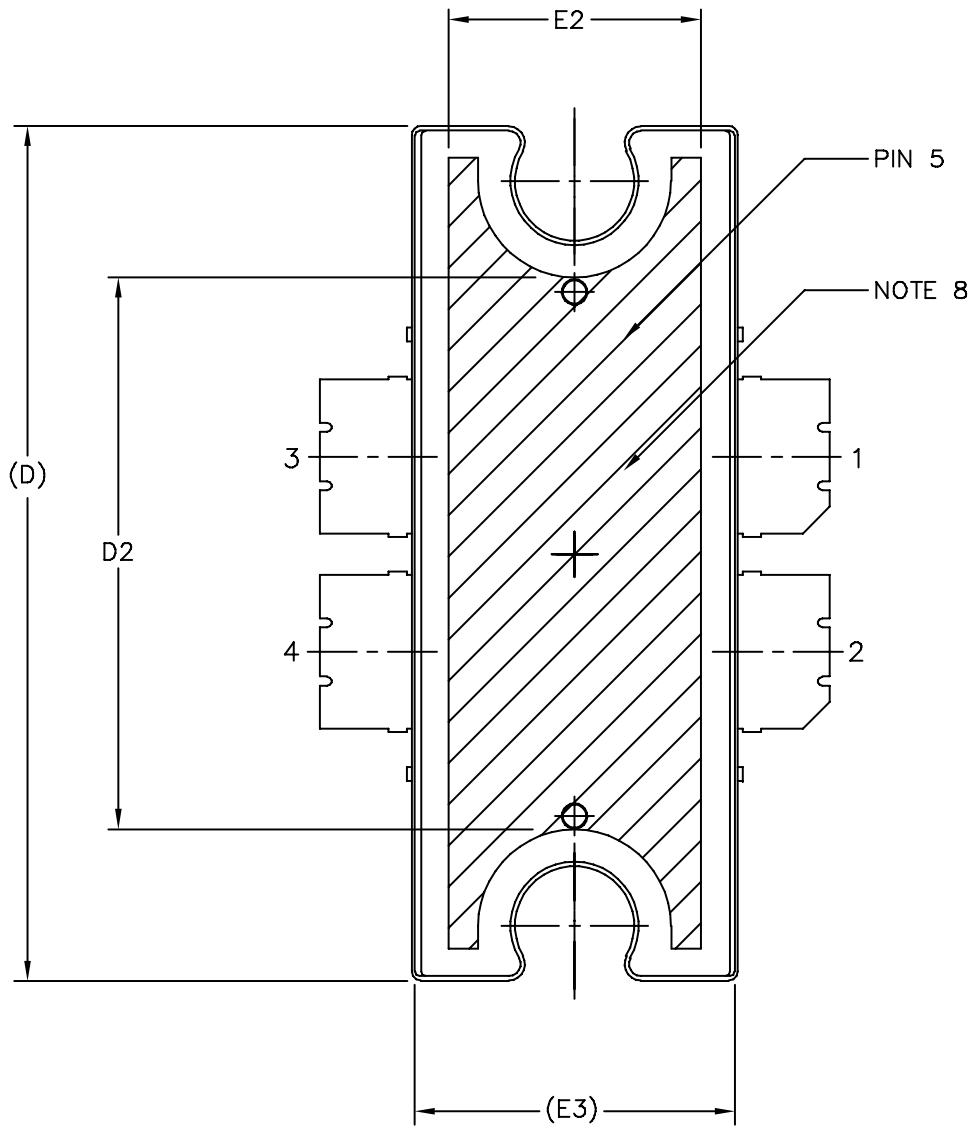

© FREESCALE SEMICONDUCTOR, INC. ALL RIGHTS RESERVED.	MECHANICAL OUTLINE	PRINT VERSION NOT TO SCALE	
TITLE: TO-272 4 LEAD, WIDE BODY	DOCUMENT NO: 98ASA10575D	REV: D	
	CASE NUMBER: 1484-04	05 APR 2006	
	STANDARD: NON-JEDEC		

NOTES:

1. CONTROLLING DIMENSION: INCH
2. INTERPRET DIMENSIONS AND TOLERANCES PER ASME Y14.5M-1994.
3. DATUM PLANE H IS LOCATED AT THE TOP OF LEAD AND IS COINCIDENT WITH THE LEAD WHERE THE LEAD EXITS THE PLASTIC BODY AT THE TOP OF THE PARTING LINE.
4. DIMENSIONS "D" AND "E1" DO NOT INCLUDE MOLD PROTRUSION. ALLOWABLE PROTRUSION IS .006 PER SIDE. DIMENSIONS "D" AND "E1" DO INCLUDE MOLD MISMATCH AND ARE DETERMINED AT DATUM PLANE H.
5. DIMENSIONS "b1" DOES NOT INCLUDE DAMBAR PROTRUSION. ALLOWABLE DAMBAR PROTRUSION SHALL BE .005 TOTAL IN EXCESS OF THE "b1" DIMENSION AT MAXIMUM MATERIAL CONDITION.
6. DATUM A AND B TO BE DETERMINED AT DATUM PLANE H.
7. DIMENSION A2 APPLIES WITHIN ZONE "J" ONLY.
8. HATCHING REPRESENTS EXPOSED AREA OF THE HEAT SLUG. HATCHED AREA SHOWN IS ON THE SAME PLANE.

STYLE 1:

PIN 1 - DRAIN PIN 2 - DRAIN
 PIN 3 - GATE PIN 4 - GATE
 PIN 5 - SOURCE

DIM	INCH		MILLIMETER		DIM	INCH		MILLIMETER	
	MIN	MAX	MIN	MAX		MIN	MAX	MIN	MAX
A	.100	.104	2.54	2.64	b1	.164	.170	4.17	4.32
A1	.039	.043	0.99	1.09	c1	.007	.011	.18	.28
A2	.040	.042	1.02	1.07	r1	.063	.068	1.60	1.73
D	.928	.932	23.57	23.67	e	.106 BSC		2.69 BSC	
D1	.810 BSC		20.57 BSC		e1	.239 INFO ONLY		6.07 INFO ONLY	
D2	.600	---	15.24	---	aaa	.004		.10	
E	.551	.559	14	14.2					
E1	.353	.357	8.97	9.07					
E2	.270	---	6.86	---					
E3	.346	.350	8.79	8.89					
F	.025 BSC		0.64 BSC						

© FREESCALE SEMICONDUCTOR, INC.
 ALL RIGHTS RESERVED.

MECHANICAL OUTLINE

PRINT VERSION NOT TO SCALE

TITLE: TO-272 4 LEAD WIDE BODY	DOCUMENT NO: 98ASA10575D	REV: D
	CASE NUMBER: 1484-04	05 APR 2006
	STANDARD: NON-JEDEC	

How to Reach Us:

Home Page:

www.freescale.com

E-mail:

support@freescale.com

USA/Europe or Locations Not Listed:

Freescale Semiconductor
Technical Information Center, CH370
1300 N. Alma School Road
Chandler, Arizona 85224
+1-800-521-6274 or +1-480-768-2130
support@freescale.com

Europe, Middle East, and Africa:

Freescale Halbleiter Deutschland GmbH
Technical Information Center
Schatzbogen 7
81829 Muenchen, Germany
+44 1296 380 456 (English)
+46 8 52200080 (English)
+49 89 92103 559 (German)
+33 1 69 35 48 48 (French)
support@freescale.com

Japan:

Freescale Semiconductor Japan Ltd.
Headquarters
ARCO Tower 15F
1-8-1, Shimo-Meguro, Meguro-ku,
Tokyo 153-0064
Japan
0120 191014 or +81 3 5437 9125
support.japan@freescale.com

Asia/Pacific:

Freescale Semiconductor Hong Kong Ltd.
Technical Information Center
2 Dai King Street
Tai Po Industrial Estate
Tai Po, N.T., Hong Kong
+800 2666 8080
support.asia@freescale.com

For Literature Requests Only:

Freescale Semiconductor Literature Distribution Center
P.O. Box 5405
Denver, Colorado 80217
1-800-441-2447 or 303-675-2140
Fax: 303-675-2150
LDCForFreescaleSemiconductor@hibbertgroup.com

Information in this document is provided solely to enable system and software implementers to use Freescale Semiconductor products. There are no express or implied copyright licenses granted hereunder to design or fabricate any integrated circuits or integrated circuits based on the information in this document.

Freescale Semiconductor reserves the right to make changes without further notice to any products herein. Freescale Semiconductor makes no warranty, representation or guarantee regarding the suitability of its products for any particular purpose, nor does Freescale Semiconductor assume any liability arising out of the application or use of any product or circuit, and specifically disclaims any and all liability, including without limitation consequential or incidental damages. "Typical" parameters that may be provided in Freescale Semiconductor data sheets and/or specifications can and do vary in different applications and actual performance may vary over time. All operating parameters, including "Typicals", must be validated for each customer application by customer's technical experts. Freescale Semiconductor does not convey any license under its patent rights nor the rights of others. Freescale Semiconductor products are not designed, intended, or authorized for use as components in systems intended for surgical implant into the body, or other applications intended to support or sustain life, or for any other application in which the failure of the Freescale Semiconductor product could create a situation where personal injury or death may occur. Should Buyer purchase or use Freescale Semiconductor products for any such unintended or unauthorized application, Buyer shall indemnify and hold Freescale Semiconductor and its officers, employees, subsidiaries, affiliates, and distributors harmless against all claims, costs, damages, and expenses, and reasonable attorney fees arising out of, directly or indirectly, any claim of personal injury or death associated with such unintended or unauthorized use, even if such claim alleges that Freescale Semiconductor was negligent regarding the design or manufacture of the part.

Freescale™ and the Freescale logo are trademarks of Freescale Semiconductor, Inc. All other product or service names are the property of their respective owners.

© Freescale Semiconductor, Inc. 2006. All rights reserved.

