

RF Power Field Effect Transistors

N-Channel Enhancement-Mode Lateral MOSFETs

Designed primarily for pulsed wideband applications with frequencies up to 450 MHz. Devices are unmatched and are suitable for use in industrial, medical and scientific applications.

- Typical Pulsed Performance at 450 MHz: $V_{DD} = 50$ Volts, $I_{DQ} = 150$ mA, $P_{out} = 1000$ Watts Peak, Pulse Width = 100 μ sec, Duty Cycle = 20%
Power Gain — 20 dB
Drain Efficiency — 64%
- Capable of Handling 10:1 VSWR, @ 50 Vdc, 450 MHz, 1000 Watts Peak Power

Features

- Qualified Up to a Maximum of 50 V_{DD} Operation
- Integrated ESD Protection
- Excellent Thermal Stability
- Designed for Push-Pull Operation
- Greater Negative Gate-Source Voltage Range for Improved Class C Operation
- RoHS Compliant
- In Tape and Reel. R6 Suffix = 150 Units per 56 mm, 13 inch Reel.

MRF6VP41KHR6
MRF6VP41KHSR6

10-450 MHz, 1000 W, 50 V
LATERAL N-CHANNEL
BROADBAND
RF POWER MOSFETs

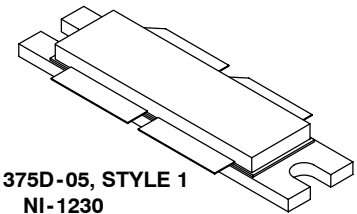

CASE 375D-05, STYLE 1
NI-1230
MRF6VP41KHR6

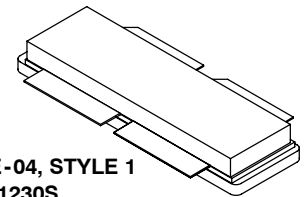

CASE 375E-04, STYLE 1
NI-1230S
MRF6VP41KHSR6

PARTS ARE PUSH-PULL

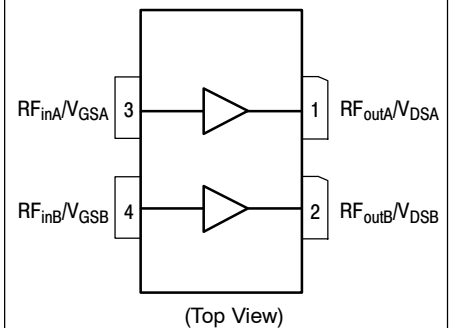

Figure 1. Pin Connections

Table 1. Maximum Ratings

Rating	Symbol	Value	Unit
Drain-Source Voltage	V_{DSS}	-0.5, +110	Vdc
Gate-Source Voltage	V_{GS}	-6, +10	Vdc
Storage Temperature Range	T_{stg}	-65 to +150	$^{\circ}$ C
Case Operating Temperature	T_C	150	$^{\circ}$ C
Operating Junction Temperature	T_J	200	$^{\circ}$ C

Table 2. Thermal Characteristics

Characteristic	Symbol	Value (1,2)	Unit
Thermal Resistance, Junction to Case Case Temperature 80°C, 1000 W Pulsed, 100 µsec Pulse Width, 20% Duty Cycle	$R_{\theta JC}$	0.03	°C/W

Table 3. ESD Protection Characteristics

Test Methodology	Class
Human Body Model (per JESD22-A114)	2 (Minimum)
Machine Model (per EIA/JESD22-A115)	A (Minimum)
Charge Device Model (per JESD22-C101)	IV (Minimum)

Table 4. Electrical Characteristics ($T_C = 25^\circ\text{C}$ unless otherwise noted)

Characteristic	Symbol	Min	Typ	Max	Unit
----------------	--------	-----	-----	-----	------

Off Characteristics ⁽³⁾

Gate-Source Leakage Current ($V_{GS} = 5 \text{ Vdc}$, $V_{DS} = 0 \text{ Vdc}$)	I_{GSS}	—	—	10	µAdc
Drain-Source Breakdown Voltage ($I_D = 300 \text{ mA}$, $V_{GS} = 0 \text{ Vdc}$)	$V_{(BR)DSS}$	110	—	—	Vdc
Zero Gate Voltage Drain Leakage Current ($V_{DS} = 50 \text{ Vdc}$, $V_{GS} = 0 \text{ Vdc}$)	I_{DSS}	—	—	100	µAdc
Zero Gate Voltage Drain Leakage Current ($V_{DS} = 100 \text{ Vdc}$, $V_{GS} = 0 \text{ Vdc}$)	I_{DSS}	—	—	5	mA

On Characteristics

Gate Threshold Voltage ⁽³⁾ ($V_{DS} = 10 \text{ Vdc}$, $I_D = 1600 \text{ µAdc}$)	$V_{GS(th)}$	1	1.68	3	Vdc
Gate Quiescent Voltage ⁽⁴⁾ ($V_{DD} = 50 \text{ Vdc}$, $I_D = 150 \text{ mAdc}$, Measured in Functional Test)	$V_{GS(Q)}$	1.5	2.2	3.5	Vdc
Drain-Source On-Voltage ⁽³⁾ ($V_{GS} = 10 \text{ Vdc}$, $I_D = 4 \text{ Adc}$)	$V_{DS(on)}$	—	0.28	—	Vdc

Dynamic Characteristics ⁽³⁾

Reverse Transfer Capacitance ($V_{DS} = 50 \text{ Vdc} \pm 30 \text{ mV(rms)ac}$ @ 1 MHz, $V_{GS} = 0 \text{ Vdc}$)	C_{rss}	—	3.3	—	pF
Output Capacitance ($V_{DS} = 50 \text{ Vdc} \pm 30 \text{ mV(rms)ac}$ @ 1 MHz, $V_{GS} = 0 \text{ Vdc}$)	C_{oss}	—	147	—	pF
Input Capacitance ($V_{DS} = 50 \text{ Vdc}$, $V_{GS} = 0 \text{ Vdc} \pm 30 \text{ mV(rms)ac}$ @ 1 MHz)	C_{iss}	—	506	—	pF

Functional Tests ⁽⁴⁾ (In Freescale Test Fixture, 50 ohm system) $V_{DD} = 50 \text{ Vdc}$, $I_{DQ} = 150 \text{ mA}$, $P_{out} = 1000 \text{ W Peak}$ (200 W Avg.), $f = 450 \text{ MHz}$, 100 µsec Pulse Width, 20% Duty Cycle

Power Gain	G_{ps}	19	20	22	dB
Drain Efficiency	η_D	60	64	—	%
Input Return Loss	IRL	—	-18	-9	dB

1. MTTF calculator available at <http://www.freescale.com/rf>. Select Software & Tools/Development Tools/Calculators to access MTTF calculators by product.
2. Refer to AN1955, *Thermal Measurement Methodology of RF Power Amplifiers*. Go to <http://www.freescale.com/rf>. Select Documentation/Application Notes - AN1955.
3. Each side of device measured separately.
4. Measurement made with device in push-pull configuration.

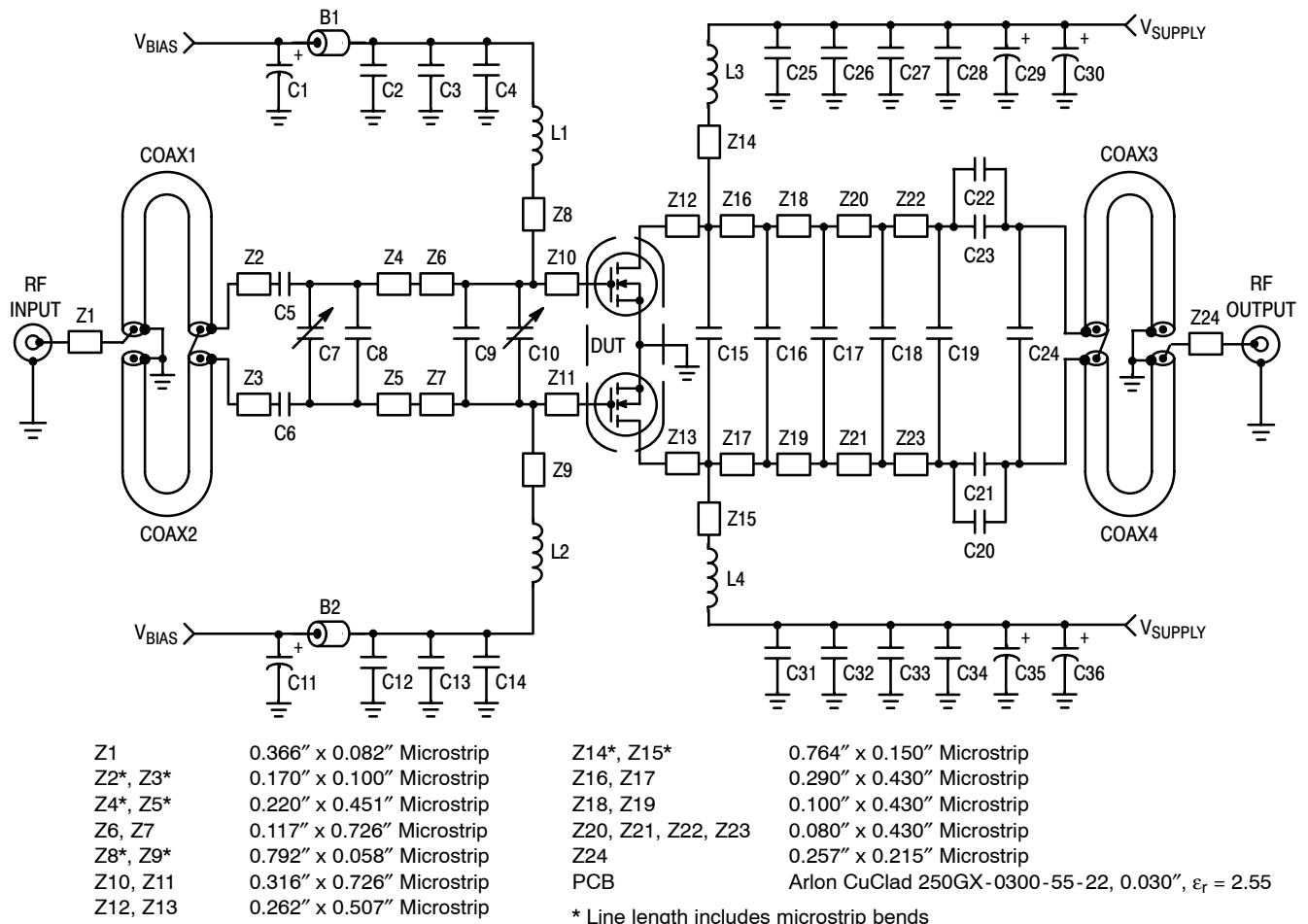

Figure 2. MRF6VP41KHR6 Test Circuit Schematic

Table 5. MRF6VP41KHR6 Test Circuit Component Designations and Values

Part	Description	Part Number	Manufacturer
B1, B2	47 Ω , 100 MHz Short Ferrite Beads	2743019447	Fair-Rite
C1, C11	47 μ F, 50 V Electrolytic Capacitors	476KXM063M	Illinois
C2, C12, C28, C34	0.1 μ F Chip Capacitors	CDR33BX104AKYS	Kemet
C3, C13, C27, C33	220 nF, 50 V Chip Capacitors	C1812C224K5RAC	Kemet
C4, C14	2.2 μ F, 50 V Chip Capacitors	C1825C225J5RAC	Kemet
C5, C6, C8, C15	27 pF Chip Capacitors	ATC100B270JT500XT	ATC
C7, C10	0.8-8.0 pF Variable Capacitors	27291SL	Johanson Components
C9	33 pF Chip Capacitor	ATC100B330JT500XT	ATC
C16	12 pF Chip Capacitor	ATC100B120JT500XT	ATC
C17	10 pF Chip Capacitor	ATC100B100JT500XT	ATC
C18	9.1 pF Chip Capacitor	ATC100B9R1CT500XT	ATC
C19	8.2 pF Chip Capacitor	ATC100B8R2CT500XT	ATC
C20, C21, C22, C23, C25, C32	240 pF Chip Capacitors	ATC100B241JT200XT	ATC
C24	5.6 pF Chip Capacitor	ATC100B5R6CT500XT	ATC
C26, C31	2.2 μ F, 100 V Chip Capacitors	2225X7R225KT3AB	ATC
C29, C30, C35, C36	330 μ F, 63 V Electrolytic Capacitors	EMVY630GTR331MMH0S	Multicomp
Coax1, 2, 3, 4	25 Ω Semi Rigid Coax, 2.2" Long	UT-141C-25	Micro-Coax
L1, L2	2.5 nH, 1 Turn Inductors	A01TKLC	CoilCraft
L3, L4	43 nH, 10 Turn Inductors	B10TJLC	Coilcraft

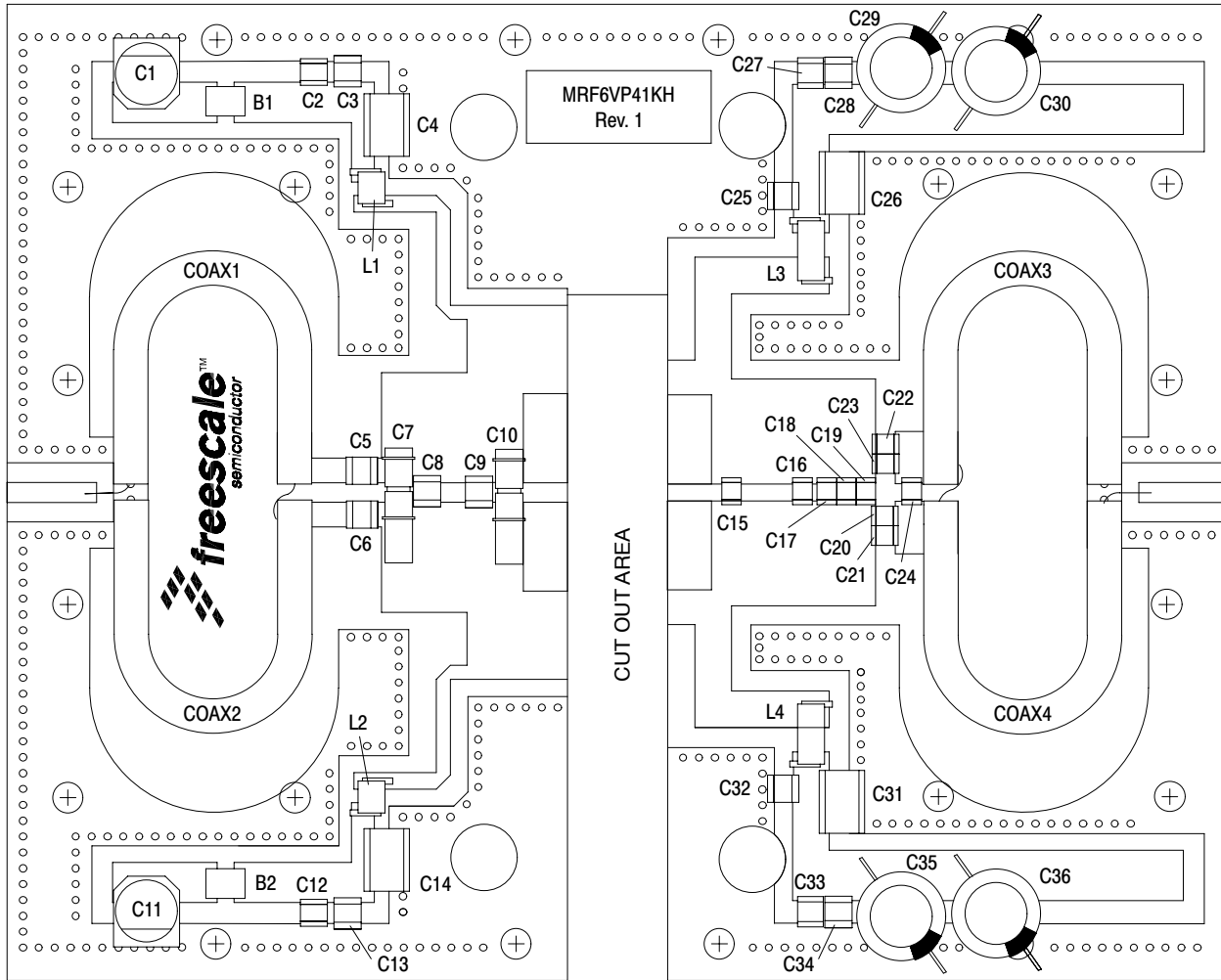

Figure 3. MRF6VP41KHR6 Test Circuit Component Layout

TYPICAL CHARACTERISTICS

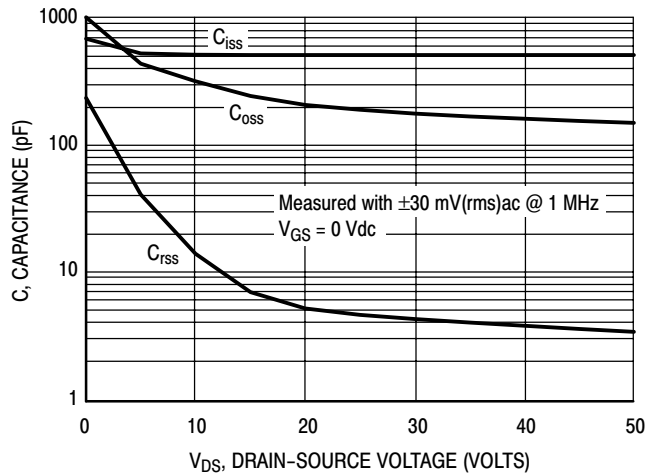

Figure 4. Capacitance versus Drain-Source Voltage

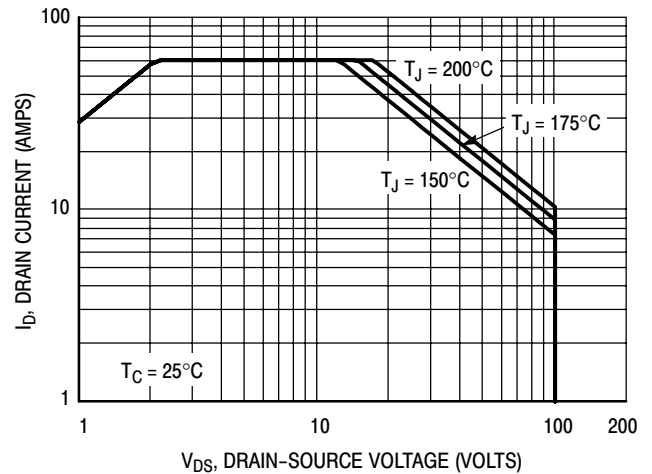

Figure 5. DC Safe Operating Area

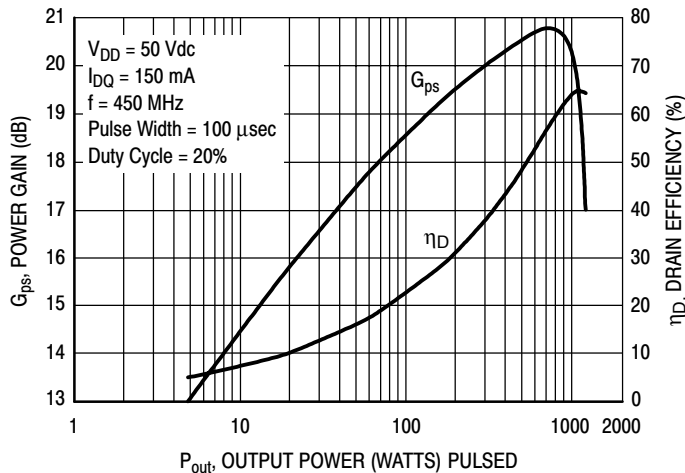

Figure 6. Pulsed Power Gain and Drain Efficiency versus Output Power

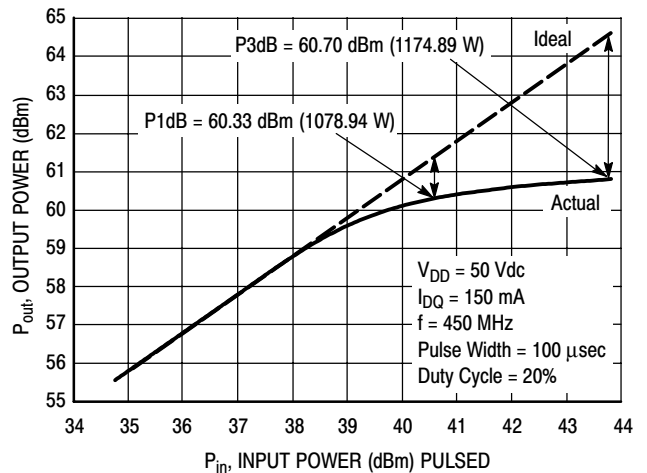

Figure 7. Pulsed Output Power versus Input Power

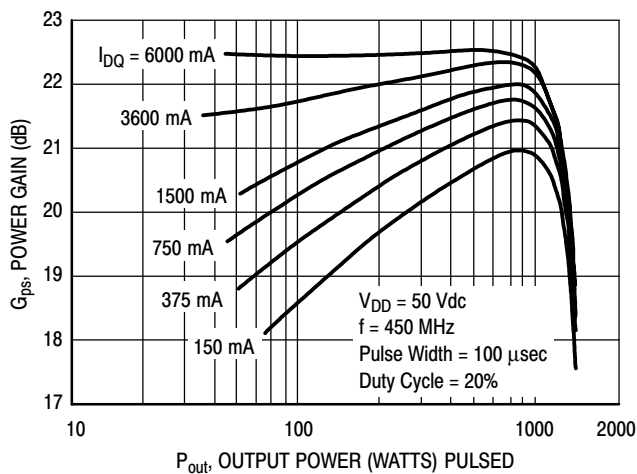

Figure 8. Pulsed Power Gain versus Output Power

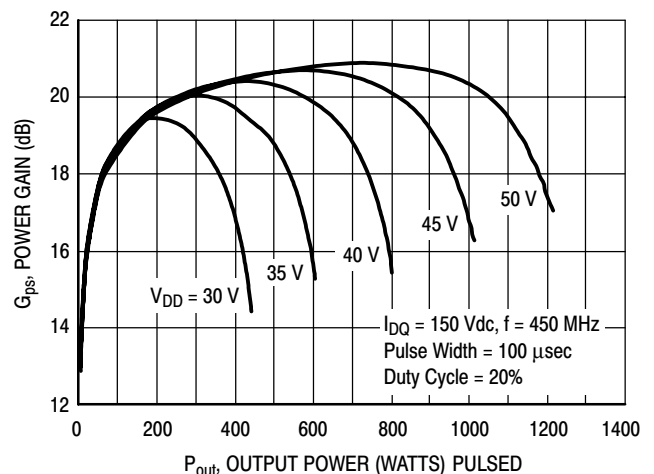

Figure 9. Pulsed Power Gain versus Output Power

TYPICAL CHARACTERISTICS

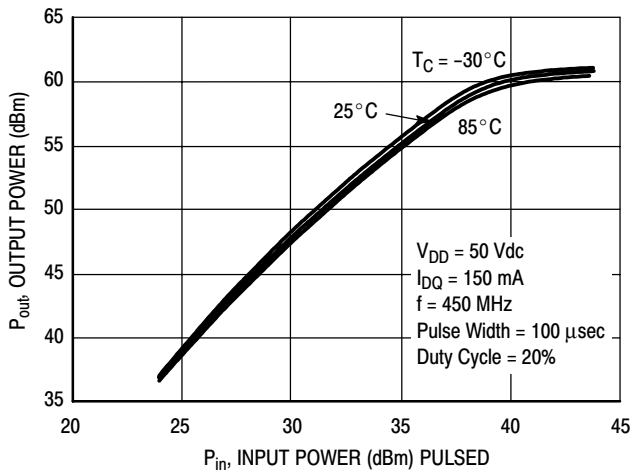

Figure 10. Pulsed Output Power versus Input Power

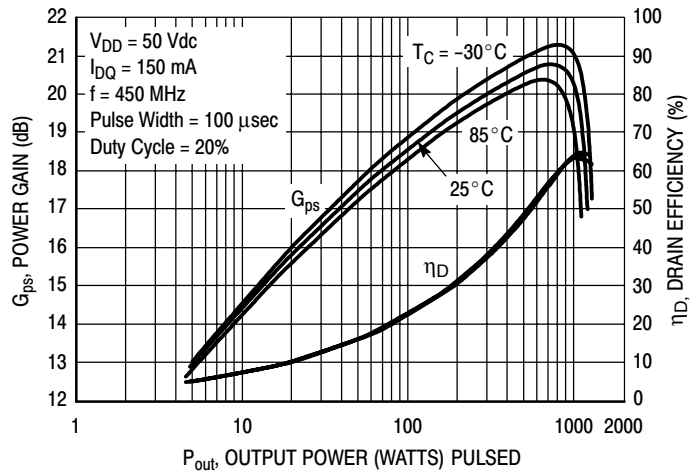
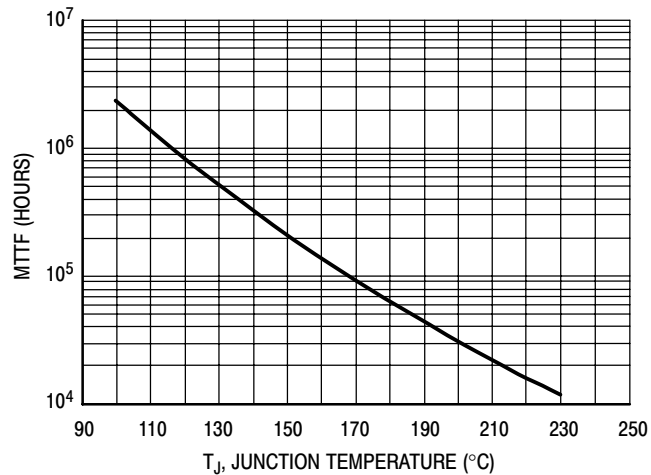

Figure 11. Pulsed Power Gain and Drain Efficiency versus Output Power



This above graph displays calculated MTTF in hours when the device is operated at $V_{DD} = 50$ Vdc, $P_{out} = 1000$ W Peak, Pulse Width = 100 μ sec, Duty Cycle = 20%, and $\eta_D = 64\%$.

MTTF calculator available at <http://www.freescale.com/rf>. Select Software & Tools/Development Tools/Calculators to access MTTF calculators by product.

Figure 12. MTTF versus Junction Temperature

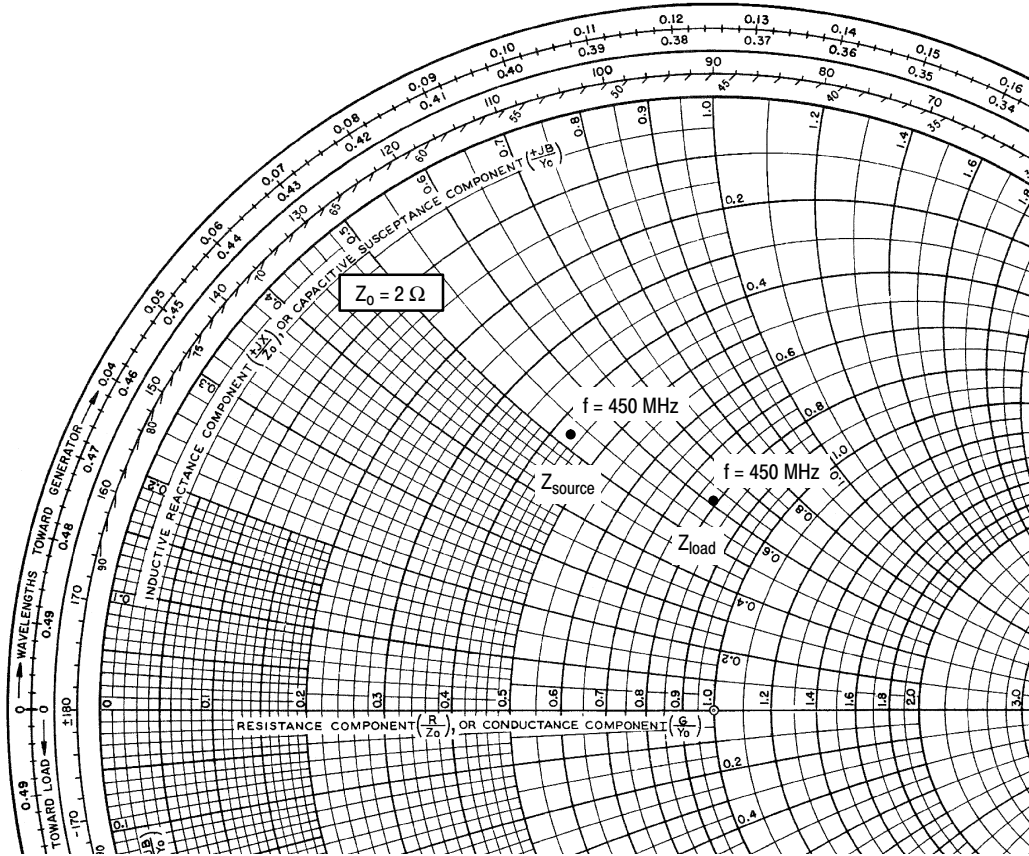

$V_{DD} = 50 \text{ Vdc}$, $I_{DQ} = 150 \text{ mA}$, $P_{out} = 1000 \text{ W Peak}$

f MHz	Z _{source} Ω	Z _{load} Ω
450	0.86 + j1.06	1.58 + j1.22

Z_{source} = Test circuit impedance as measured from gate to ground.

Z_{load} = Test circuit impedance as measured from drain to ground.

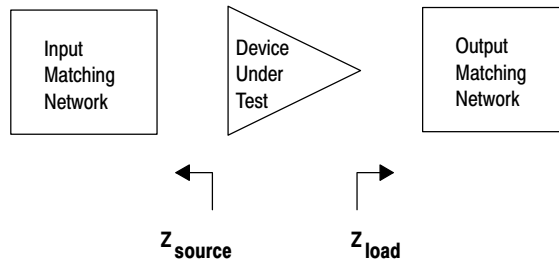
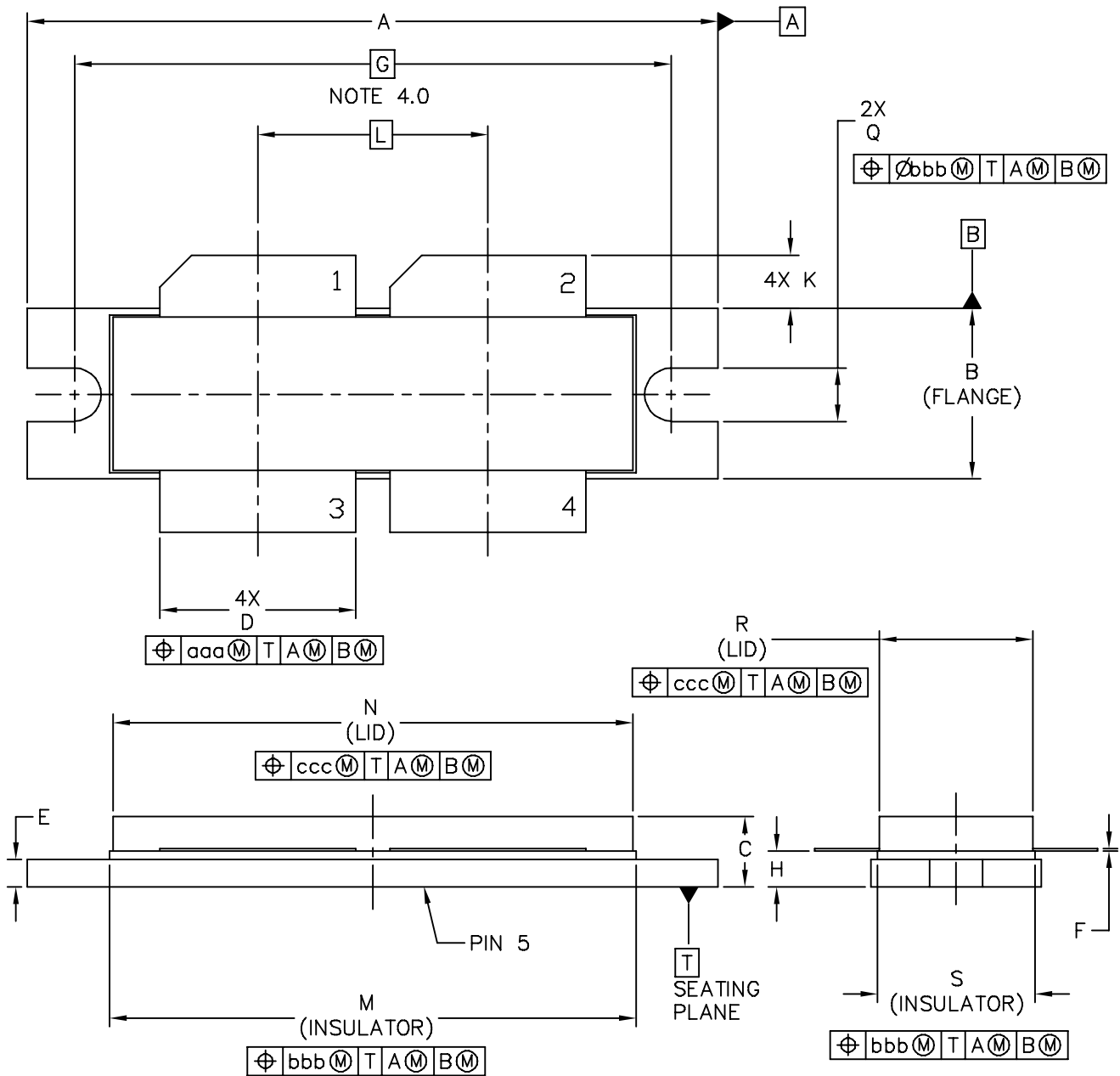

Figure 13. Series Equivalent Source and Load Impedance

PACKAGE DIMENSIONS



© FREESCALE SEMICONDUCTOR, INC. ALL RIGHTS RESERVED.	MECHANICAL OUTLINE	PRINT VERSION NOT TO SCALE
TITLE: <div style="text-align: center; font-size: 1.2em;">NI-1230</div>	DOCUMENT NO: 98ASB16977C	REV: E
	CASE NUMBER: 375D-05	31 MAR 2005
	STANDARD: NON-JEDEC	

MRF6VP41KHR6 MRF6VP41KHSR6

NOTES:

- 1.0 INTERPRET DIMENSIONS AND TOLERANCES PER ASME Y14.5M-1994.
- 2.0 CONTROLLING DIMENSION: INCH
- 3.0 DIMENSION H IS MEASURED .030 (0.762) AWAY FROM PACKAGE BODY.
- 4.0 RECOMMENDED BOLT CENTER DIMENSION OF 1.52 (38.61) BASED ON M3 SCREW.

STYLE 1:

- PIN 1 - DRAIN
- 2 - DRAIN
- 3 - GATE
- 4 - GATE
- 5 - SOURCE

DIM	INCH		MILLIMETER		DIM	INCH		MILLIMETER	
	MIN	MAX	MIN	MAX		MIN	MAX	MIN	MAX
A	1.615	1.625	41.02	41.28	N	1.218	1.242	30.94	31.55
B	.395	.405	10.03	10.29	Q	.120	.130	3.05	3.3
C	.150	.200	3.81	5.08	R	.355	.365	9.01	9.27
D	.455	.465	11.56	11.81	S	.365	.375	9.27	9.53
E	.062	.066	1.57	1.68					
F	.004	.007	0.1	0.18					
G	1.400 BSC		35.56 BSC		aaa	.013		0.33	
H	.082	.090	2.08	2.29	bbb	.010		0.25	
K	.117	.137	2.97	3.48	ccc	.020		0.51	
L	.540 BSC		13.72 BSC						
M	1.219	1.241	30.96	31.52					
© FREESCALE SEMICONDUCTOR, INC. ALL RIGHTS RESERVED.			MECHANICAL OUTLINE			PRINT VERSION NOT TO SCALE			
TITLE: NI-1230					DOCUMENT NO: 98ASB16977C			REV: E	
					CASE NUMBER: 375D-05			31 MAR 2005	
					STANDARD: NON-JEDEC				

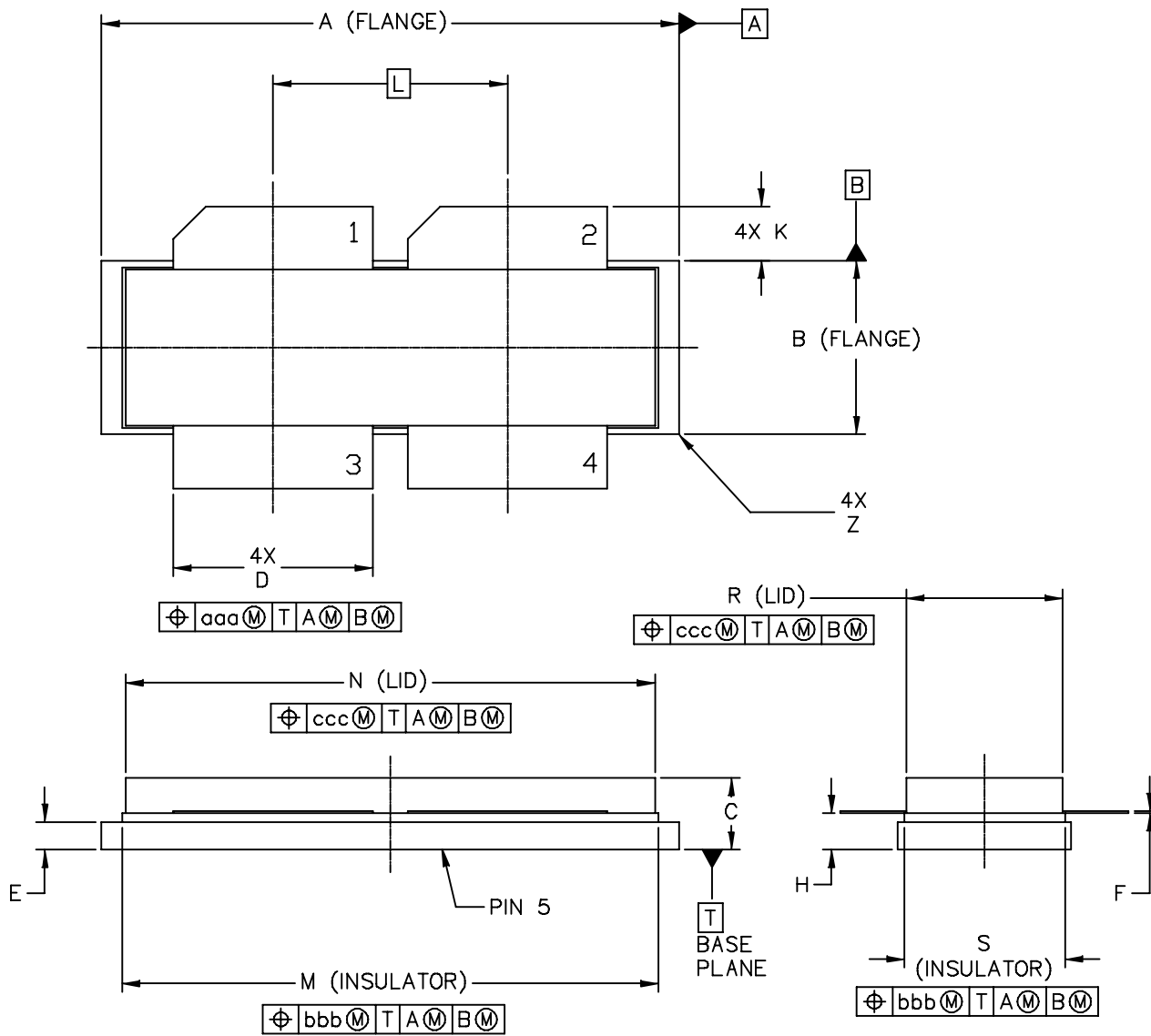

© FREESCALE SEMICONDUCTOR, INC. ALL RIGHTS RESERVED.	MECHANICAL OUTLINE	PRINT VERSION NOT TO SCALE	
TITLE: NI-1230S	DOCUMENT NO: 98ARB18247C	REV: F	
	CASE NUMBER: 375E-04	05 AUG 2005	
	STANDARD: NON-JEDEC		

NOTES:

1. INTERPRET DIMENSIONS AND TOLERANCES PER ASME Y14.5M-1994.
2. CONTROLLING DIMENSION: INCH
3. DIMENSION H IS MEASURED .030 AWAY FROM PACKAGE BODY

STYLE 1:

- PIN 1 - DRAIN
- 2 - DRAIN
- 3 - GATE
- 4 - GATE
- 5 - SOURCE

DIM	INCHES		MILLIMETERS		DIM	INCHES		MILLIMETERS	
	MIN	MAX	MIN	MAX		MIN	MAX	MIN	MAX
A	1.265	1.275	32.13	32.38	R	.355	.365	9.01	9.27
B	.395	.405	10.03	10.29	S	.365	.375	9.27	9.53
C	.150	.200	3.81	5.08	Z	---	.040	---	1.02
D	.455	.465	11.56	11.81					
E	.062	.066	1.57	1.68	aaa	.013		0.33	
F	.004	.007	0.1	0.18	bbb	.010		0.25	
H	.082	.090	2.08	2.29	ccc	.020		0.51	
K	.117	.137	2.97	3.48					
L	.540 BSC		13.72 BSC						
M	1.219	1.241	30.96	31.52					
N	1.218	1.242	30.94	31.55					
© FREESCALE SEMICONDUCTOR, INC. ALL RIGHTS RESERVED.			MECHANICAL OUTLINE			PRINT VERSION NOT TO SCALE			
TITLE: NI-1230S					DOCUMENT NO: 98ARB18247C			REV: F	
					CASE NUMBER: 375E-04			05 AUG 2005	
					STANDARD: NON-JEDEC				

PRODUCT DOCUMENTATION

Refer to the following documents to aid your design process.

Application Notes

- AN1955: Thermal Measurement Methodology of RF Power Amplifiers

Engineering Bulletins

- EB212: Using Data Sheet Impedances for RF LDMOS Devices

REVISION HISTORY

The following table summarizes revisions to this document.

Revision	Date	Description
0	Jan. 2008	<ul style="list-style-type: none">• Initial Release of Data Sheet

How to Reach Us:

Home Page:

www.freescale.com

Web Support:

<http://www.freescale.com/support>

USA/Europe or Locations Not Listed:

Freescale Semiconductor, Inc.
Technical Information Center, EL516
2100 East Elliot Road
Tempe, Arizona 85284
+1-800-521-6274 or +1-480-768-2130
www.freescale.com/support

Europe, Middle East, and Africa:

Freescale Halbleiter Deutschland GmbH
Technical Information Center
Schatzbogen 7
81829 Muenchen, Germany
+44 1296 380 456 (English)
+46 8 52200080 (English)
+49 89 92103 559 (German)
+33 1 69 35 48 48 (French)
www.freescale.com/support

Japan:

Freescale Semiconductor Japan Ltd.
Headquarters
ARCO Tower 15F
1-8-1, Shimo-Meguro, Meguro-ku,
Tokyo 153-0064
Japan
0120 191014 or +81 3 5437 9125
support.japan@freescale.com

Asia/Pacific:

Freescale Semiconductor Hong Kong Ltd.
Technical Information Center
2 Dai King Street
Tai Po Industrial Estate
Tai Po, N.T., Hong Kong
+800 2666 8080
support.asia@freescale.com

For Literature Requests Only:

Freescale Semiconductor Literature Distribution Center
P.O. Box 5405
Denver, Colorado 80217
1-800-441-2447 or 303-675-2140
Fax: 303-675-2150
LDCForFreescaleSemiconductor@hibbertgroup.com

Information in this document is provided solely to enable system and software implementers to use Freescale Semiconductor products. There are no express or implied copyright licenses granted hereunder to design or fabricate any integrated circuits or integrated circuits based on the information in this document.

Freescale Semiconductor reserves the right to make changes without further notice to any products herein. Freescale Semiconductor makes no warranty, representation or guarantee regarding the suitability of its products for any particular purpose, nor does Freescale Semiconductor assume any liability arising out of the application or use of any product or circuit, and specifically disclaims any and all liability, including without limitation consequential or incidental damages. "Typical" parameters that may be provided in Freescale Semiconductor data sheets and/or specifications can and do vary in different applications and actual performance may vary over time. All operating parameters, including "Typicals", must be validated for each customer application by customer's technical experts. Freescale Semiconductor does not convey any license under its patent rights nor the rights of others. Freescale Semiconductor products are not designed, intended, or authorized for use as components in systems intended for surgical implant into the body, or other applications intended to support or sustain life, or for any other application in which the failure of the Freescale Semiconductor product could create a situation where personal injury or death may occur. Should Buyer purchase or use Freescale Semiconductor products for any such unintended or unauthorized application, Buyer shall indemnify and hold Freescale Semiconductor and its officers, employees, subsidiaries, affiliates, and distributors harmless against all claims, costs, damages, and expenses, and reasonable attorney fees arising out of, directly or indirectly, any claim of personal injury or death associated with such unintended or unauthorized use, even if such claim alleges that Freescale Semiconductor was negligent regarding the design or manufacture of the part.

Freescale™ and the Freescale logo are trademarks of Freescale Semiconductor, Inc. All other product or service names are the property of their respective owners.

© Freescale Semiconductor, Inc. 2008. All rights reserved.

