

The RF MOSFET Line
RF Power Field Effect Transistors
N-Channel Enhancement-Mode Lateral MOSFETs

MRF5S21100LR3
MRF5S21100LSR3

Designed for W-CDMA base station applications with frequencies from 2110 to 2170 MHz. Suitable for TDMA, CDMA and multicarrier amplifier applications. To be used in Class AB for PCN - PCS/cellular radio and WLL applications.

- Typical 2-carrier W-CDMA Performance for $V_{DD} = 28$ Volts, $I_{DQ} = 1050$ mA, $f_1 = 2135$ MHz, $f_2 = 2145$ MHz, Channel Bandwidth = 3.84 MHz, Adjacent Channels Measured over 3.84 MHz BW @ $f_1 - 5$ MHz and $f_2 + 5$ MHz, Distortion Products Measured over a 3.84 MHz BW @ $f_1 - 10$ MHz and $f_2 + 10$ MHz, Peak/Avg. = 8.5 dB @ 0.01% Probability on CCDF.
 - Output Power — 23 Watts Avg.
 - Power Gain — 13.5 dB
 - Efficiency — 26%
 - IM3 — -37 dBc
 - ACPR — -40 dBc
- Internally Matched, Controlled Q, for Ease of Use
- High Gain, High Efficiency and High Linearity
- Integrated ESD Protection
- Designed for Maximum Gain and Insertion Phase Flatness
- Capable of Handling 10:1 VSWR, @ 28 Vdc, 2140 MHz, 100 Watts CW Output Power
- Excellent Thermal Stability
- Characterized with Series Equivalent Large-Signal Impedance Parameters
- Qualified Up to a Maximum of 32 V_{DD} Operation
- Low Gold Plating Thickness on Leads. L Suffix Indicates 40 μ " Nominal.
- In Tape and Reel. R3 Suffix = 250 Units per 56 mm, 13 inch Reel.

2170 MHz, 23 W AVG.,
2 x W-CDMA, 28 V
LATERAL N-CHANNEL
RF POWER MOSFETs

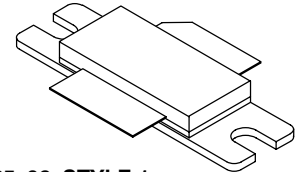

CASE 465-06, STYLE 1
NI-780
MRF5S21100LR3

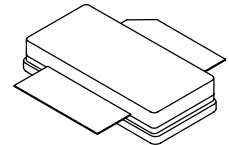

CASE 465A-06, STYLE 1
NI-780S
MRF5S21100LSR3

MAXIMUM RATINGS

Rating	Symbol	Value	Unit
Drain-Source Voltage	V_{DSS}	65	Vdc
Gate-Source Voltage	V_{GS}	-0.5, +15	Vdc
Total Device Dissipation @ $T_C = 25^\circ\text{C}$ Derate above 25 $^\circ\text{C}$	P_D	250 1.43	Watts W/ $^\circ\text{C}$
Storage Temperature Range	T_{stg}	-65 to +150	$^\circ\text{C}$
Operating Junction Temperature	T_J	200	$^\circ\text{C}$

THERMAL CHARACTERISTICS

Characteristic	Symbol	Value (1)	Unit
Thermal Resistance, Junction to Case Case Temperature 80 $^\circ\text{C}$, 100 W CW Case Temperature 80 $^\circ\text{C}$, 23 W CW	$R_{\theta JC}$	0.70 0.76	$^\circ\text{C}/\text{W}$

(1) Refer to AN1955/D, *Thermal Measurement Methodology of RF Power Amplifiers*. Go to <http://www.motorola.com/semiconductors/rl>. Select Documentation/Application Notes - AN1955.

NOTE - CAUTION - MOS devices are susceptible to damage from electrostatic charge. Reasonable precautions in handling and packaging MOS devices should be observed.

ESD PROTECTION CHARACTERISTICS

Test Conditions	Class
Human Body Model	2 (Minimum)
Machine Model	M3 (Minimum)
Charge Device Model	C7 (Minimum)

ELECTRICAL CHARACTERISTICS (T_C = 25°C unless otherwise noted)

Characteristic	Symbol	Min	Typ	Max	Unit
----------------	--------	-----	-----	-----	------

OFF CHARACTERISTICS

Zero Gate Voltage Drain Leakage Current (V _{DS} = 65 Vdc, V _{GS} = 0 Vdc)	I _{DSS}	—	—	10	μA _{dc}
Zero Gate Voltage Drain Leakage Current (V _{DS} = 28 Vdc, V _{GS} = 0 Vdc)	I _{DSS}	—	—	1	μA _{dc}
Gate-Source Leakage Current (V _{GS} = 5 Vdc, V _{DS} = 0 Vdc)	I _{GSS}	—	—	0.5	μA _{dc}

ON CHARACTERISTICS (DC)

Gate Threshold Voltage (V _{DS} = 10 Vdc, I _D = 250 μA _{dc})	V _{GS(th)}	2.5	2.8	3.5	Vdc
Gate Quiescent Voltage (V _{DS} = 28 Vdc, I _D = 1050 mA _{dc})	V _{GS(Q)}	—	3.8	—	Vdc
Drain-Source On-Voltage (V _{GS} = 10 Vdc, I _D = 2.5 A _{dc})	V _{DS(on)}	—	0.24	0.3	Vdc
Forward Transconductance (V _{DS} = 10 Vdc, I _D = 2.5 A _{dc})	g _{fs}	—	6	—	S

DYNAMIC CHARACTERISTICS (1)

Reverse Transfer Capacitance (V _{DS} = 28 Vdc ± 30 mV(rms) _{ac} @ 1 MHz, V _{GS} = 0 Vdc)	C _{r_{ss}}	—	2.14	—	pF
--	-----------------------------	---	------	---	----

FUNCTIONAL TESTS (In Motorola Test Fixture, 50 ohm system) 2-carrier W-CDMA, 3.84 MHz Channel Bandwidth Carriers, ACPR and IM3 measured in 3.84 MHz Bandwidth. Peak/Avg. = 8.5 dB @ 0.01% Probability on CCDF.

Common-Source Amplifier Power Gain (V _{DD} = 28 Vdc, P _{out} = 23 W Avg., I _{DQ} = 1050 mA, f ₁ = 2112.5 MHz, f ₂ = 2122.5 MHz and f ₁ = 2157.5 MHz, f ₂ = 2167.5 MHz)	G _{ps}	12.5	13.5	—	dB
Drain Efficiency (V _{DD} = 28 Vdc, P _{out} = 23 W Avg., I _{DQ} = 1050 mA, f ₁ = 2112.5 MHz, f ₂ = 2122.5 MHz and f ₁ = 2157.5 MHz, f ₂ = 2167.5 MHz)	η	24	26	—	%
Third Order Intermodulation Distortion (V _{DD} = 28 Vdc, P _{out} = 23 W Avg., I _{DQ} = 1050 mA, f ₁ = 2112.5 MHz, f ₂ = 2122.5 MHz and f ₁ = 2157.5 MHz, f ₂ = 2167.5 MHz; IM3 measured over 3.84 MHz BW at f ₁ -10 MHz and f ₂ +10 MHz referenced to carrier channel power.)	IM3	—	-37	-35	dBc
Adjacent Channel Power Ratio (V _{DD} = 28 Vdc, P _{out} = 23 W Avg., I _{DQ} = 1050 mA, f ₁ = 2112.5 MHz, f ₂ = 2122.5 MHz and f ₁ = 2157.5 MHz, f ₂ = 2167.5 MHz; ACPR measured over 3.84 MHz at f ₁ -5 MHz and f ₂ +5 MHz.)	ACPR	—	-40	-38	dBc
Input Return Loss (V _{DD} = 28 Vdc, P _{out} = 23 W Avg., I _{DQ} = 1050 mA, f ₁ = 2112.5 MHz, f ₂ = 2122.5 MHz and f ₁ = 2157.5 MHz, f ₂ = 2167.5 MHz)	IRL	—	-16	-9	dB

(1) Part is internally matched both on input and output.

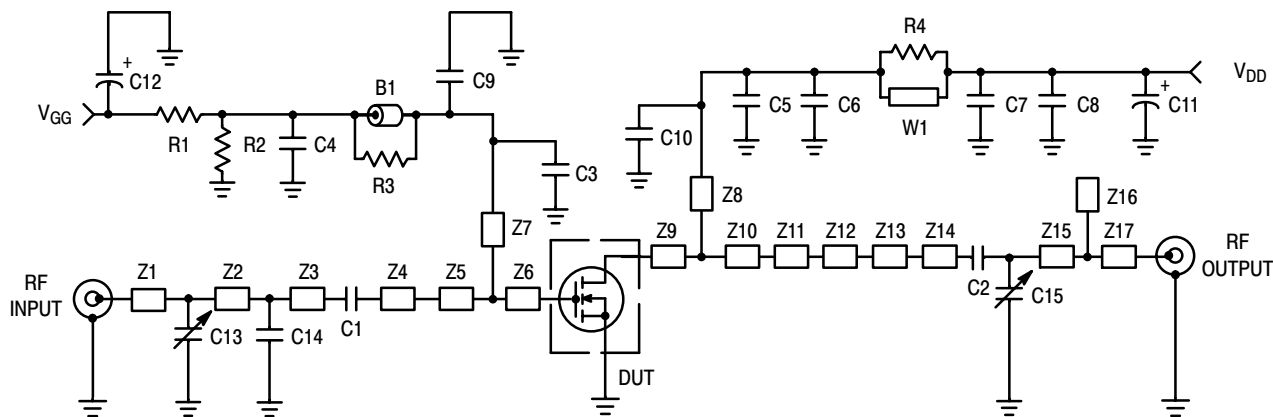

Z1	0.674" x 0.080" Microstrip	Z10	0.368" x 1.136" Microstrip
Z2	0.421" x 0.080" Microstrip	Z11	0.151" x 0.393" Microstrip
Z3	0.140" x 0.080" Microstrip	Z12	0.280" x 0.220" Microstrip
Z4	1.031" x 0.080" Microstrip	Z13	0.481" x 0.142" Microstrip
Z5	0.380" x 0.643" Microstrip	Z14	0.138" x 0.080" Microstrip
Z6	0.080" x 0.643" Microstrip	Z15	0.344" x 0.080" Microstrip
Z7	0.927" x 0.048" Microstrip	Z16	0.147" x 0.099" Microstrip
Z8	0.620" x 0.048" Microstrip	Z17	0.859" x 0.080" Microstrip
Z9	0.079" x 1.136" Microstrip	PCB	Arlon GX-0300-SS-22, 30 mil, $\epsilon_r = 2.55$

Figure 1. MRF5S21100L Test Circuit Schematic

Table 1. MRF5S21100L Test Circuit Component Designations and Values

Part	Description	Value, P/N or DWG	Manufacturer
B1	Short RF Bead	95F786	Newark
C1, C2	8.2 pF Chip Capacitors, B Case	100B8R2CP500X	ATC
C3	5.6 pF Chip Capacitor, B Case	100B5R6CP500X	ATC
C4	0.1 μ F Chip Capacitor, B Case	CDR33BX104AKWS	Kemet
C5, C7	7.5 pF Chip Capacitors, B Case	100B7R5JP500X	ATC
C6	1.2 pF Chip Capacitor, B Case	100B1R2BP500X	ATC
C8	1K pF Chip Capacitor, B Case	100B102JP500X	ATC
C9, C10	0.56 μ F Chip Capacitors, B Case	700A561MP150X	Kemet
C11	470 μ F, 63 V Electrolytic Capacitor	95F4579	Newark
C12	100 μ F, 50 V Electrolytic Capacitor	51F2913	Newark
C13	0.6 - 4.5 pF Gigatrim Variable Capacitor	44F3358	Newark
C14	2.7 pF Chip Capacitor, B Case	100B2R7CP500X	ATC
C15	0.4 - 2.5 pF Gigatrim Variable Capacitor	44F3367	Newark
R1	1 k Ω Chip Resistor	D5534M07B1K00R	Newark
R2	560 k Ω Chip Resistor	CR1206564JT	Newark
R3, R4	12 Ω Chip Resistors	RM73B2B120JT	Garrett Electronics
W1	Wire Strap	14 Gauge Jumper Wire	

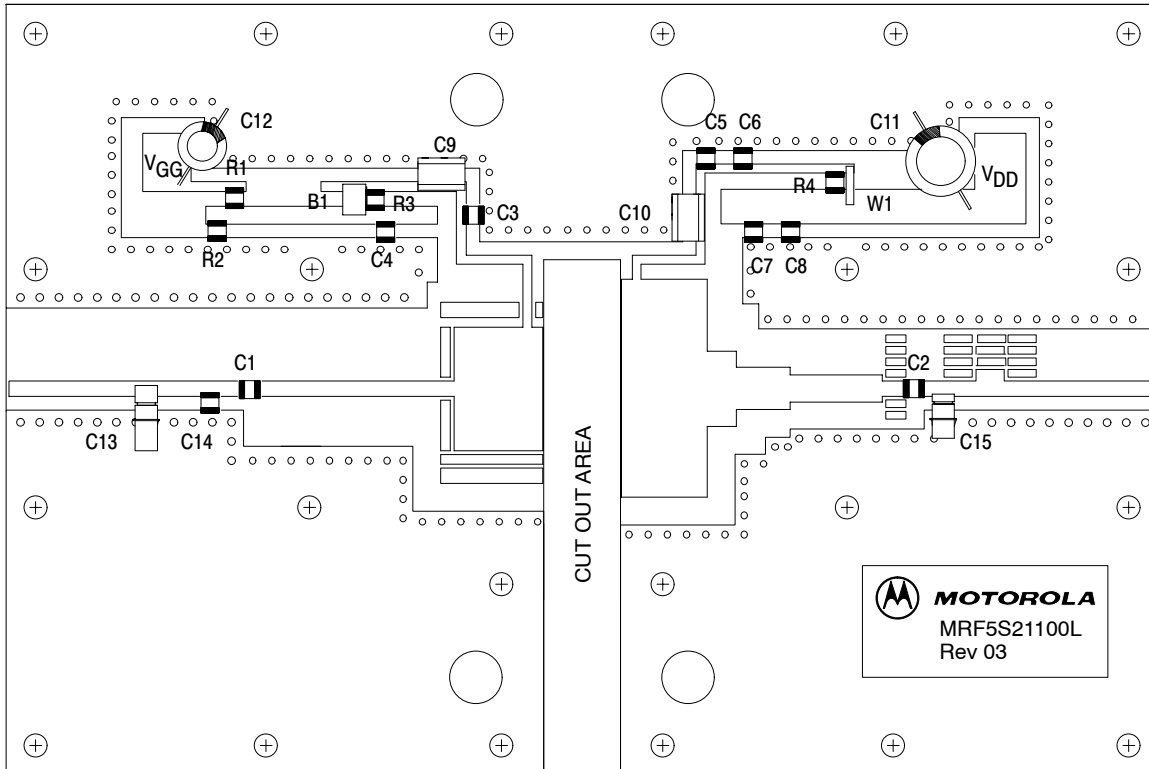

Figure 2. MRF5S21100L Test Circuit Component Layout

Freescale Semiconductor, Inc.

TYPICAL CHARACTERISTICS

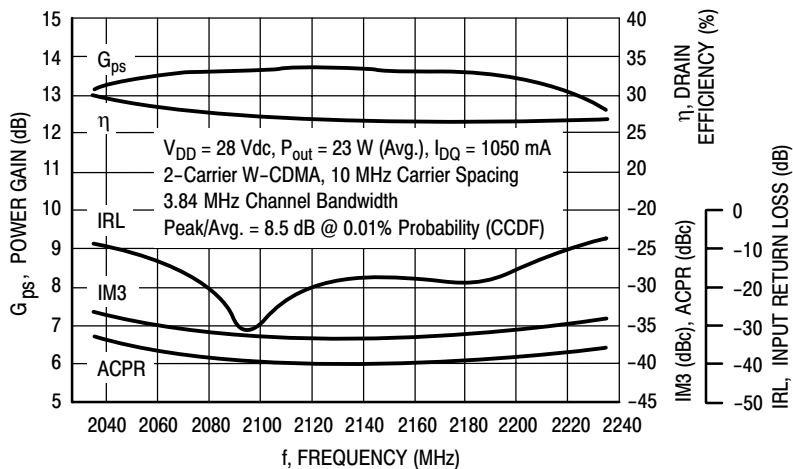

Figure 3. 2-Carrier W-DCMA Broadband Performance

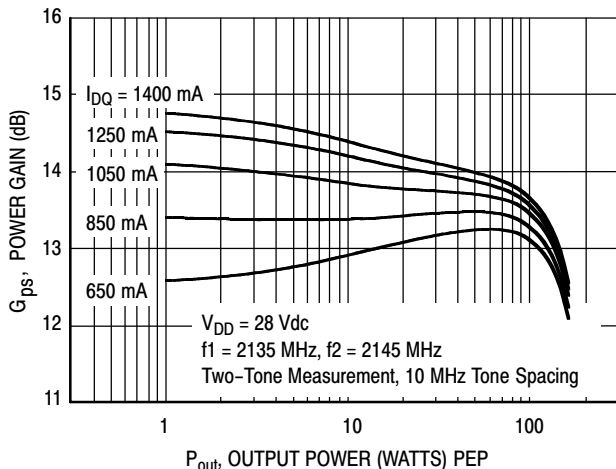

Figure 4. Two-Tone Power Gain versus Output Power

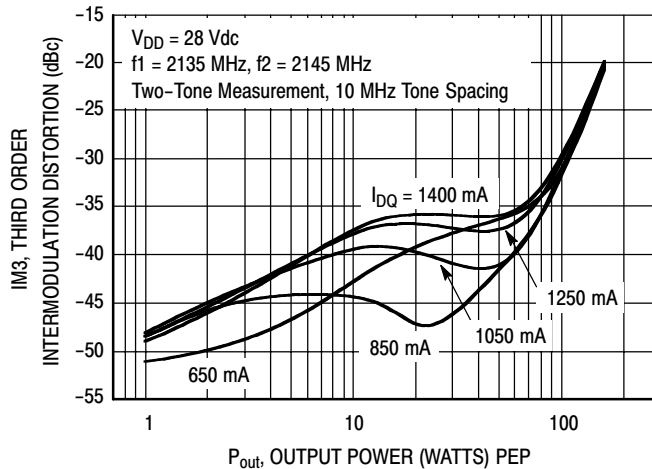

Figure 5. Third Order Intermodulation Distortion versus Output Power

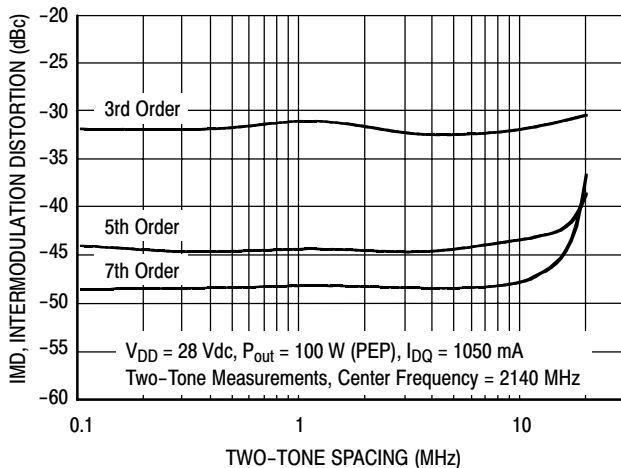

Figure 6. Intermodulation Distortion Products versus Tone Spacing

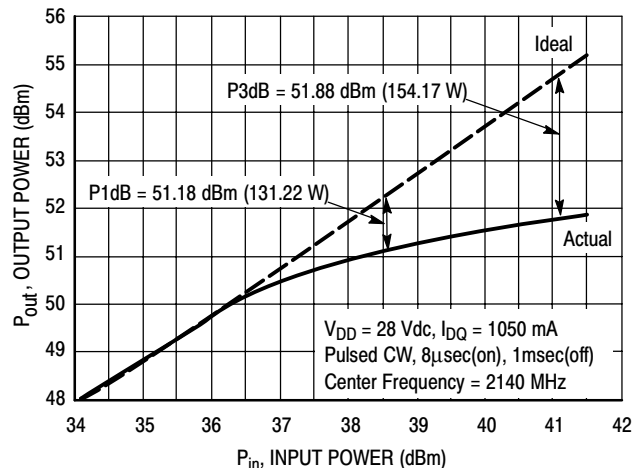

Figure 7. Pulse CW Output Power versus Input Power

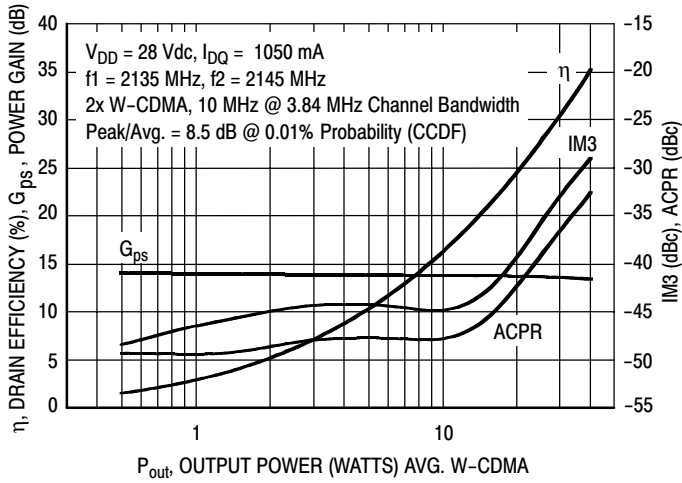

Figure 8. 2-Carrier W-CDMA ACPR, IM3, Power Gain and Drain Efficiency versus Output Power

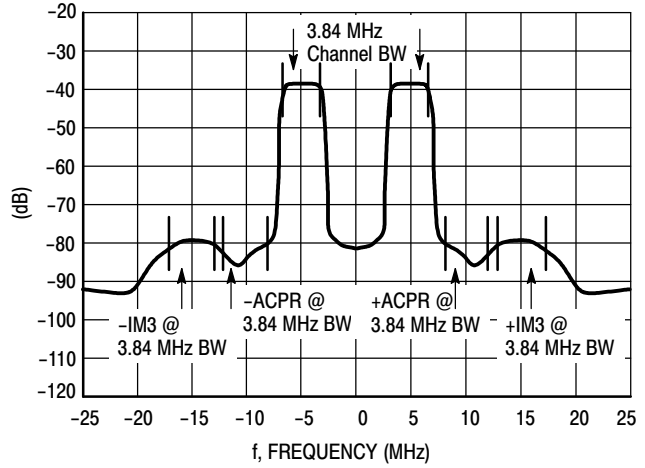

Figure 9. 2-Carrier W-CDMA Spectrum

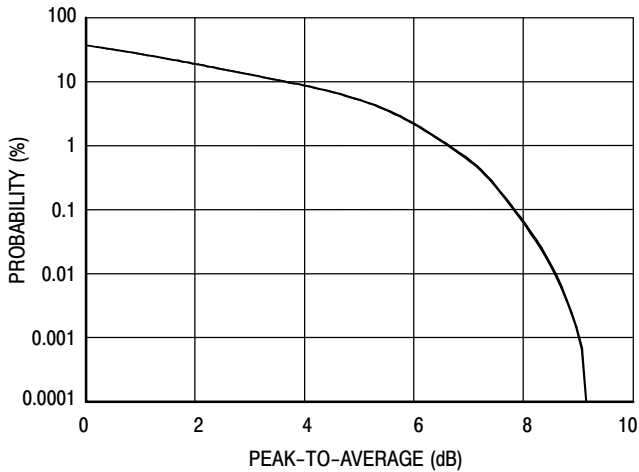
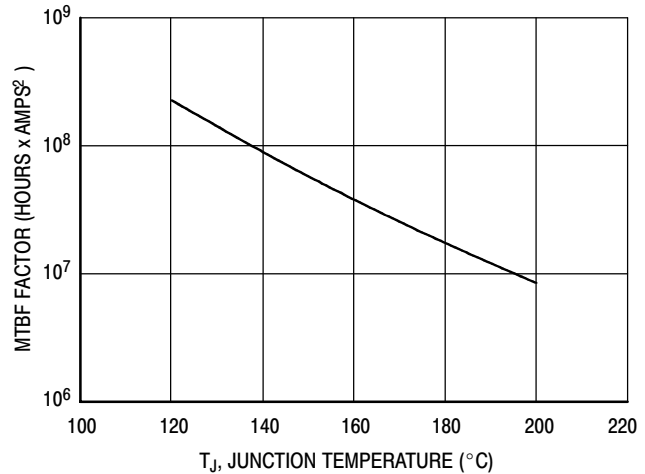
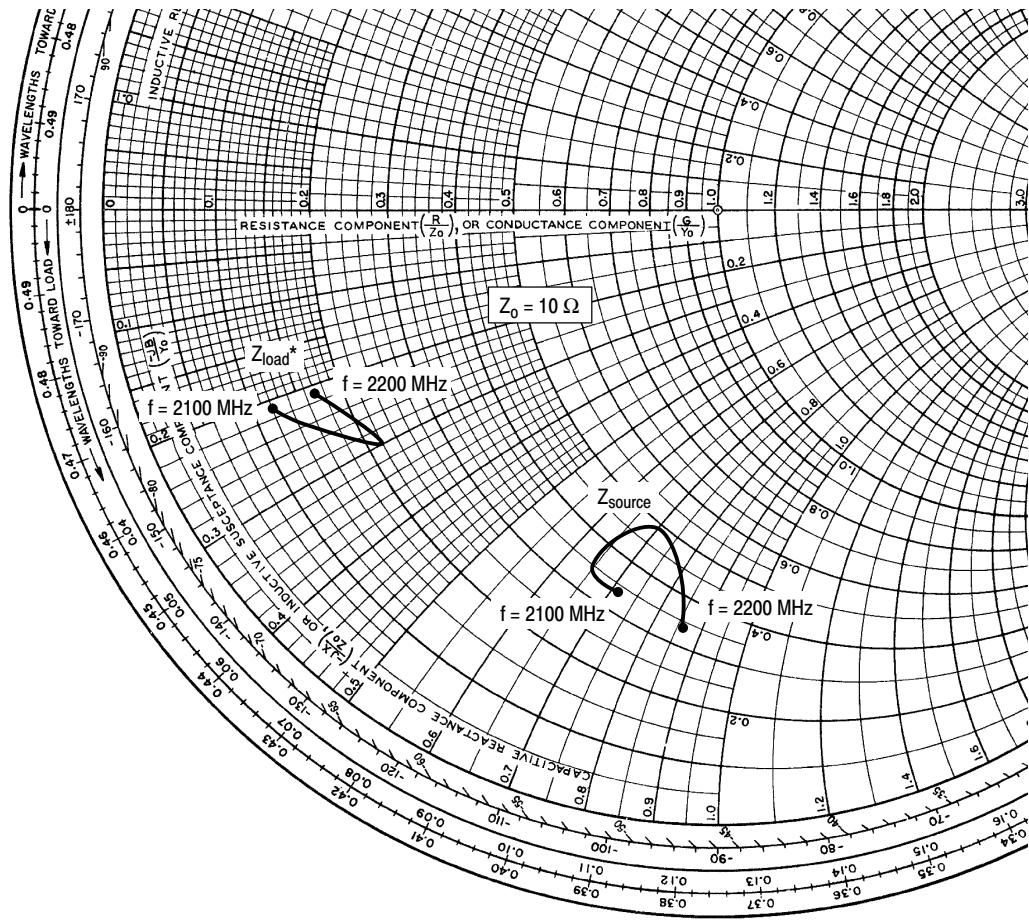

Figure 10. CCDF W-CDMA 3GPP, Test Model 1, 64 DPCH, 67% Clipping, Single Carrier Test Signal



This above graph displays calculated MTBF in hours x ampere² drain current. Life tests at elevated temperatures have correlated to better than $\pm 10\%$ of the theoretical prediction for metal failure. Divide MTBF factor by I_D^2 for MTBF in a particular application.

Figure 11. MTBF Factor versus Junction Temperature



$V_{DD} = 28 \text{ Vdc}$, $I_{DQ} = 1050 \text{ mA}$, $P_{out} = 23 \text{ W Avg.}$

f MHz	Z_{source} Ω	Z_{load} Ω
2100	$3.4 - j7.2$	$1.2 - j2.1$
2120	$3.4 - j6.5$	$1.4 - j2.3$
2160	$4.9 - j7.0$	$2.2 - j3.0$
2200	$3.4 - j8.6$	$1.7 - j2.1$

Z_{source} = Test circuit impedance as measured from gate to ground.

Z_{load} = Test circuit impedance as measured from drain to ground.

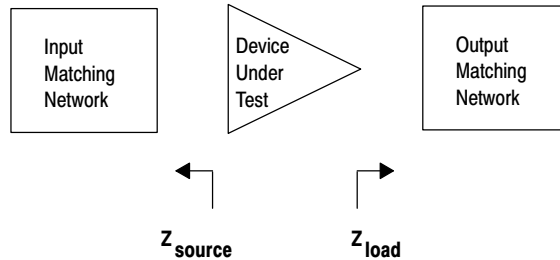

Figure 12. Series Equivalent Input and Output Impedance

NOTES

NOTES

NOTES

Freescale Semiconductor, Inc.

PACKAGE DIMENSIONS

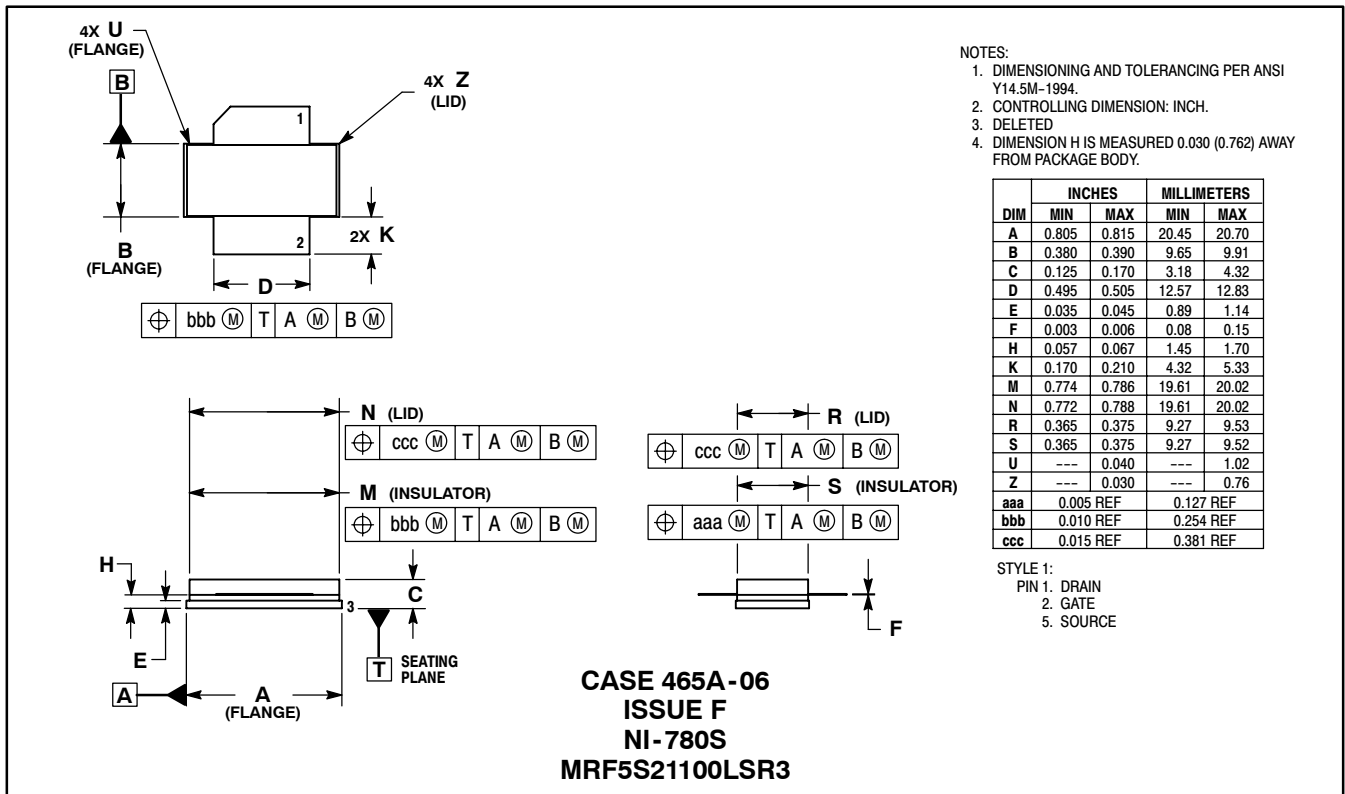
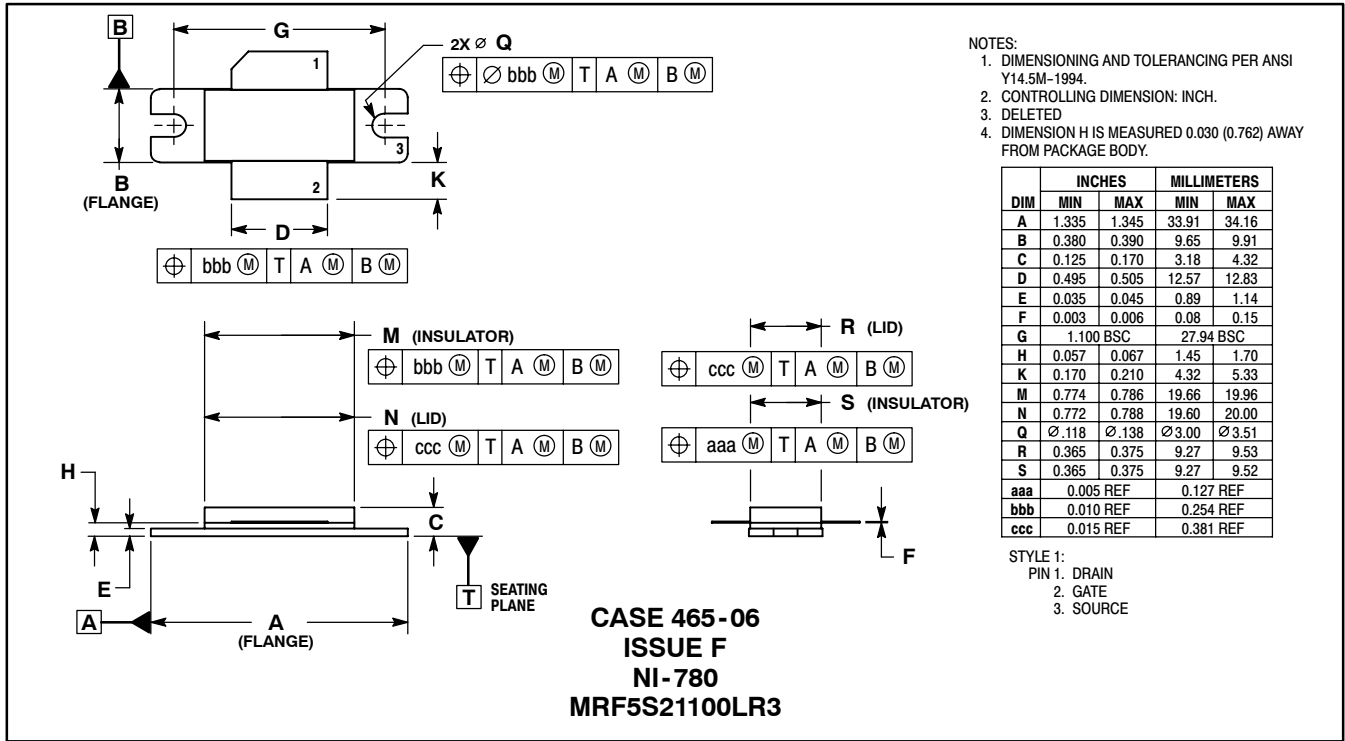

Information in this document is provided solely to enable system and software implementers to use Motorola products. There are no express or implied copyright licenses granted hereunder to design or fabricate any integrated circuits or integrated circuits based on the information in this document.

Motorola reserves the right to make changes without further notice to any products herein. Motorola makes no warranty, representation or guarantee regarding the suitability of its products for any particular purpose, nor does Motorola assume any liability arising out of the application or use of any product or circuit, and specifically disclaims any and all liability, including without limitation consequential or incidental damages. "Typical" parameters that may be provided in Motorola data sheets and/or specifications can and do vary in different applications and actual performance may vary over time. All operating parameters, including "Typicals", must be validated for each customer application by customer's technical experts. Motorola does not convey any license under its patent rights nor the rights of others. Motorola products are not designed, intended, or authorized for use as components in systems intended for surgical implant into the body, or other applications intended to support or sustain life, or for any other application in which the failure of the Motorola product could create a situation where personal injury or death may occur. Should Buyer purchase or use Motorola products for any such unintended or unauthorized application, Buyer shall indemnify and hold Motorola and its officers, employees, subsidiaries, affiliates, and distributors harmless against all claims, costs, damages, and expenses, and reasonable attorney fees arising out of, directly or indirectly, any claim of personal injury or death associated with such unintended or unauthorized use, even if such claim alleges that Motorola was negligent regarding the design or manufacture of the part.

MOTOROLA and the Stylized M Logo are registered in the US Patent and Trademark Office. All other product or service names are the property of their respective owners. Motorola, Inc. is an Equal Opportunity/Affirmative Action Employer.

© Motorola Inc. 2004

HOW TO REACH US:

USA/EUROPE/LOCATIONS NOT LISTED:
Motorola Literature Distribution
P.O. Box 5405, Denver, Colorado 80217
1-800-521-6274 or 480-768-2130

JAPAN: Motorola Japan Ltd.; SPS, Technical Information Center,
3-20-1, Minami-Azabu, Minato-ku, Tokyo 106-8573, Japan
81-3-3440-3569

ASIA/PACIFIC: Motorola Semiconductors H.K. Ltd.; Silicon Harbour Centre,
2 Dai King Street, Tai Po Industrial Estate, Tai Po, N.T., Hong Kong
852-26668334

HOME PAGE: <http://motorola.com/semiconductors>



MOTOROLA

**For More Information On This Product,
Go to: www.freescale.com**

MRF5S21100L/D