

The RF MOSFET Line  
**RF Power Field Effect Transistors**  
N-Channel Enhancement-Mode Lateral MOSFETs

Designed for PCN and PCS base station applications with frequencies up to 1.9 to 2.0 GHz. Suitable for TDMA, CDMA and multicarrier amplifier applications.

- Typical 2-Carrier N-CDMA Performance for  $V_{DD} = 28$  Volts,  
 $I_{DQ} = 850$  mA,  $f_1 = 1958.75$  MHz,  $f_2 = 1961.25$  MHz  
IS-95 CDMA (Pilot, Sync, Paging, Traffic Codes 8 Through 13)  
1.2288 MHz Channel Bandwidth Carrier. Adjacent Channels Measured over a 30 kHz Bandwidth at  $f_1 - 885$  kHz and  $f_2 + 885$  kHz. Distortion Products Measured over 1.2288 MHz Bandwidth at  $f_1 - 2.5$  MHz and  $f_2 + 2.5$  MHz. Peak/Avg. = 9.8 dB @ 0.01% Probability on CCDF.  
Output Power — 18 Watts Avg.  
Power Gain — 14.5 dB  
Efficiency — 25.8%  
ACPR — -51 dB  
IM3 — -37 dBc
- Internally Matched, Controlled Q, for Ease of Use
- High Gain, High Efficiency and High Linearity
- Integrated ESD Protection
- Designed for Maximum Gain and Insertion Phase Flatness
- Capable of Handling 10:1 VSWR, @ 28 Vdc, 1960 MHz, 90 Watts CW Output Power
- Excellent Thermal Stability
- Characterized with Series Equivalent Large-Signal Impedance Parameters
- Qualified Up to a Maximum of 32  $V_{DD}$  Operation
- Available in Tape and Reel. R3 Suffix = 250 Units per 56 mm, 13 inch Reel.
- Low Gold Plating Thickness on Leads. L Suffix Indicates 40 $\mu$  Nominal.

**MRF5S19090L**  
**MRF5S19090LR3**  
**MRF5S19090LSR3**

**1990 MHz, 18 W AVG.,**  
**2 x N-CDMA, 28 V**  
**LATERAL N-CHANNEL**  
**RF POWER MOSFETs**

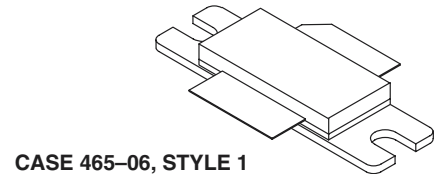

**CASE 465-06, STYLE 1**  
**NI-780**  
**MRF5S19090L**

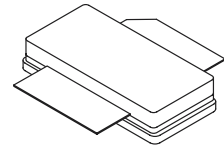

**CASE 465A-06, STYLE 1**  
**NI-780S**  
**MRF5S19090LSR3**

**MAXIMUM RATINGS**

Rating	Symbol	Value	Unit
Drain-Source Voltage	$V_{DSS}$	65	Vdc
Gate-Source Voltage	$V_{GS}$	-0.5, +15	Vdc
Total Device Dissipation @ $T_C = 25^\circ\text{C}$ Derate above $25^\circ\text{C}$	$P_D$	261 1.49	Watts W/ $^\circ\text{C}$
Storage Temperature Range	$T_{stg}$	-65 to +200	$^\circ\text{C}$
Operating Junction Temperature	$T_J$	200	$^\circ\text{C}$

**THERMAL CHARACTERISTICS**

Characteristic	Symbol	Max	Unit
Thermal Resistance, Junction to Case Case Temperature $80^\circ\text{C}$ , 90 W CW Case Temperature $80^\circ\text{C}$ , 18 W CW	$R_{\theta JC}$	0.67 0.75	$^\circ\text{C}/\text{W}$

NOTE – **CAUTION** – MOS devices are susceptible to damage from electrostatic charge. Reasonable precautions in handling and packaging MOS devices should be observed.

## ESD PROTECTION CHARACTERISTICS

Test Conditions	Class
Human Body Model	1 (Minimum)
Machine Model	M3 (Minimum)
Charge Device Model	C7 (Minimum)

## ELECTRICAL CHARACTERISTICS (T<sub>C</sub> = 25°C unless otherwise noted)

Characteristic	Symbol	Min	Typ	Max	Unit
----------------	--------	-----	-----	-----	------

### OFF CHARACTERISTICS

Zero Gate Voltage Drain Leakage Current (V <sub>DS</sub> = 65 Vdc, V <sub>GS</sub> = 0 Vdc)	I <sub>DSS</sub>	—	—	10	μA <sub>dc</sub>
Zero Gate Voltage Drain Leakage Current (V <sub>DS</sub> = 28 Vdc, V <sub>GS</sub> = 0 Vdc)	I <sub>DSS</sub>	—	—	1	μA <sub>dc</sub>
Gate–Source Leakage Current (V <sub>GS</sub> = 5 Vdc, V <sub>DS</sub> = 0 Vdc)	I <sub>GSS</sub>	—	—	1	μA <sub>dc</sub>

### ON CHARACTERISTICS (DC)

Gate Threshold Voltage (V <sub>DS</sub> = 10 Vdc, I <sub>D</sub> = 200 μA <sub>dc</sub> )	V <sub>GS(th)</sub>	2.5	2.7	3.5	Vdc
Gate Quiescent Voltage (V <sub>DS</sub> = 28 Vdc, I <sub>D</sub> = 850 mA <sub>dc</sub> )	V <sub>GS(Q)</sub>	—	3.7	—	Vdc
Drain–Source On–Voltage (V <sub>GS</sub> = 10 Vdc, I <sub>D</sub> = 2 A <sub>dc</sub> )	V <sub>DS(on)</sub>	—	0.26	—	Vdc
Forward Transconductance (V <sub>DS</sub> = 10 Vdc, I <sub>D</sub> = 2 A <sub>dc</sub> )	g <sub>fs</sub>	—	5	—	S

### DYNAMIC CHARACTERISTICS

Reverse Transfer Capacitance (1) (V <sub>DS</sub> = 28 Vdc ± 30 mV(rms) <sub>ac</sub> @ 1 MHz, V <sub>GS</sub> = 0 Vdc)	C <sub>rss</sub>	—	1.7	—	pF
--	------------------	---	-----	---	----

**FUNCTIONAL TESTS** (In Motorola Test Fixture, 50 ohm system) 2–Carrier N–CDMA, 1.2288 MHz Channel Bandwidth Carriers. ACPR measured in 30 kHz Bandwidth and IM3 measured in 1.2288 MHz Bandwidth. Peak/Avg. Ratio = 9.8 dB @ 0.01% Probability on CCDF.

Common–Source Amplifier Power Gain (V <sub>DD</sub> = 28 Vdc, P <sub>out</sub> = 18 W Avg., I <sub>DQ</sub> = 850 mA, f <sub>1</sub> = 1930 MHz, f <sub>2</sub> = 1932.5 MHz and f <sub>1</sub> = 1987.5 MHz, f <sub>2</sub> = 1990 MHz)	G <sub>ps</sub>	13.5	14.5	—	dB
Drain Efficiency (V <sub>DD</sub> = 28 Vdc, P <sub>out</sub> = 18 W Avg., I <sub>DQ</sub> = 850 mA, f <sub>1</sub> = 1930 MHz, f <sub>2</sub> = 1932.5 MHz and f <sub>1</sub> = 1987.5 MHz, f <sub>2</sub> = 1990 MHz)	η	24	25.8	—	%
Third Order Intermodulation Distortion (V <sub>DD</sub> = 28 Vdc, P <sub>out</sub> = 18 W Avg., I <sub>DQ</sub> = 850 mA, f <sub>1</sub> = 1930 MHz, f <sub>2</sub> = 1932.5 MHz and f <sub>1</sub> = 1987.5 MHz, f <sub>2</sub> = 1990 MHz); IM3 measured over 1.2288 MHz bandwidth at f <sub>1</sub> –2.5 MHz and f <sub>2</sub> = +2.5 MHz)	IM3	—	–37	–35	dBc
Adjacent Channel Power Ratio (V <sub>DD</sub> = 28 Vdc, P <sub>out</sub> = 18 W Avg., I <sub>DQ</sub> = 850 mA, f <sub>1</sub> = 1930 MHz, f <sub>2</sub> = 1932.5 MHz and f <sub>1</sub> = 1987.5 MHz, f <sub>2</sub> = 1990 MHz); ACPR measured over 30 kHz bandwidth at f <sub>1</sub> –885 kHz and f <sub>2</sub> +885 kHz)	ACPR	—	–51	–48	dBc
Input Return Loss (V <sub>DD</sub> = 28 Vdc, P <sub>out</sub> = 18 W Avg., I <sub>DQ</sub> = 850 mA, f <sub>1</sub> = 1930 MHz, f <sub>2</sub> = 1932.5 MHz and f <sub>1</sub> = 1987.5 MHz, f <sub>2</sub> = 1990 MHz)	IRL	—	–14.5	–9	dB

(1) Part is internally matched both on input and output.

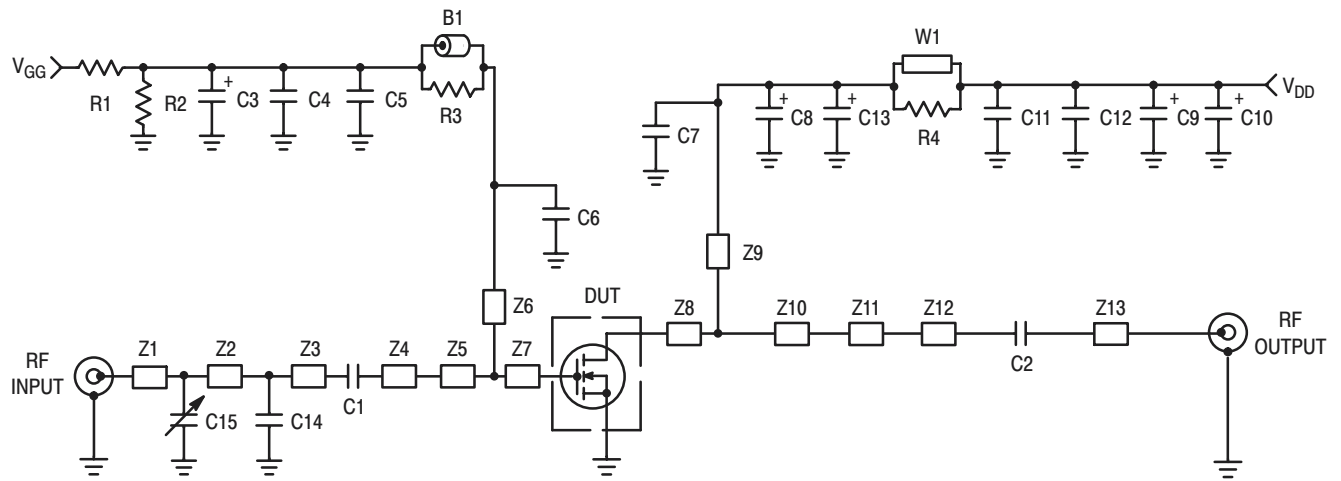

Z1	0.140" x 0.080" Microstrip	Z8	0.091" x 1.133" Microstrip
Z2	0.450" x 0.080" Microstrip	Z9	0.542" x 0.071" Microstrip
Z3	0.140" x 0.080" Microstrip	Z10	0.450" x 1.133" Microstrip
Z4	0.525" x 0.080" Microstrip	Z11	0.640" x 0.141" Microstrip
Z5	0.636" x 0.141" Microstrip	Z12	0.316" x 0.080" Microstrip
Z6	0.340" x 0.050" Microstrip	Z13	1.209" x 0.080" Microstrip
Z7	0.320" x 1.401" Microstrip	PCB	Arlon GX-0300-55-22, 30 mil, $\epsilon_r = 2.55$

Figure 1. MRF5S19090 Test Circuit Schematic

Table 1. MRF5S19090 Test Circuit Component Designations and Values

Part	Description	Value, P/N or DWG	Manufacturer
B1	Short RF Bead	95F786	Newark
C1	22 pF Chip Capacitor, B Case	100B220CP 500X	ATC
C2	10 pF Chip Capacitor, B Case	100B100CP 500X	ATC
C3, C13	1 $\mu$ F, 50 V SMT Tantalum Capacitors	T494C105(1)050AS	Kemet
C4, C12	0.1 $\mu$ F Chip Capacitors, B Case	CDR33BX104AKWS	Kemet
C5, C11	1k pF Chip Capacitors, B Case	100B102JP 500X	ATC
C6, C7	4.3 pF Chip Capacitors, B Case	100B4R3JP 500X	ATC
C8	10 $\mu$ F, 35 V SMT Tantalum Capacitor	T494D106(1)035AS	Kemet
C9, C10	22 $\mu$ F, 35 V SMT Tantalum Capacitors	T494X226(1)035AS	Kemet
C14	2.7 pF Chip Capacitor, B Case	100B2.7BP 500X	ATC
C15	0.6 – 4.5 Gigatrim Variable Capacitor	44F3358	Newark
R1	1 k $\Omega$ Chip Resistor	D5534M07B1K00R	Newark
R2	560 k $\Omega$ Chip Resistor	CR1206 564JT	Newark
R3, R4	12 $\Omega$ Chip Resistors	RM73B2B120JT	Garrett Electronics
W1	1 turn 14 gauge wire		

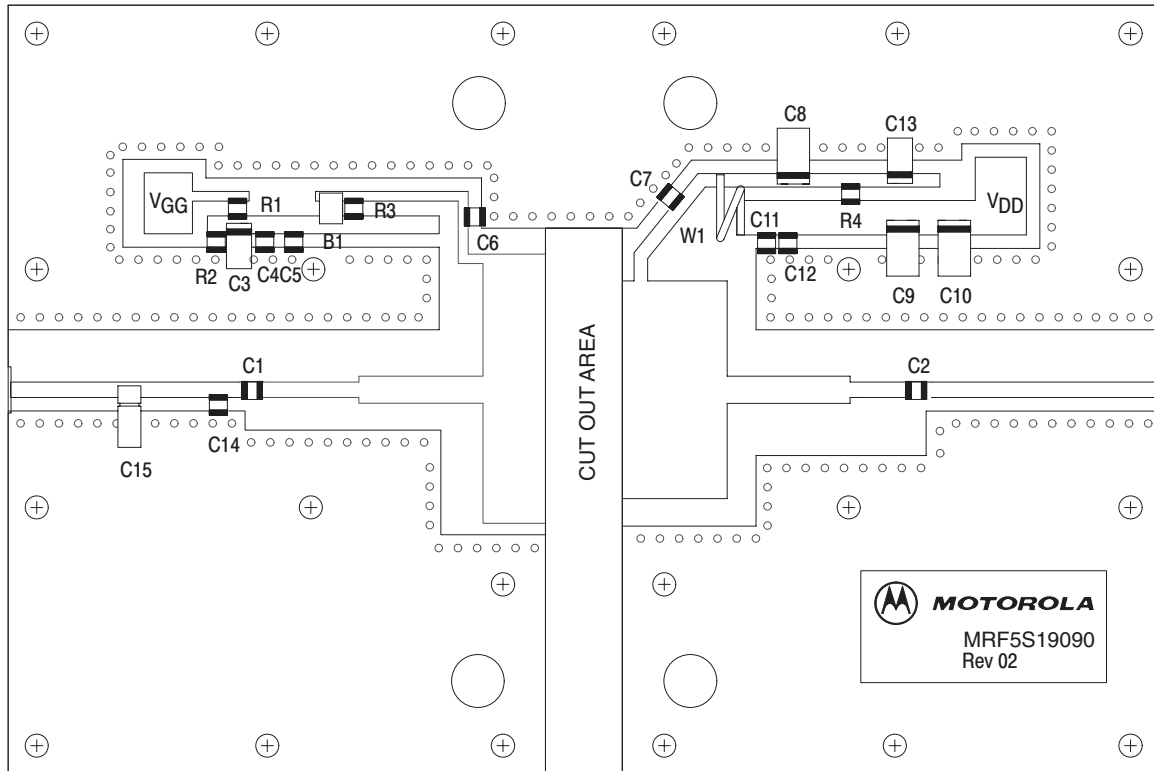

Figure 2. MRF5S19090 Test Circuit Component Layout

## TYPICAL CHARACTERISTICS

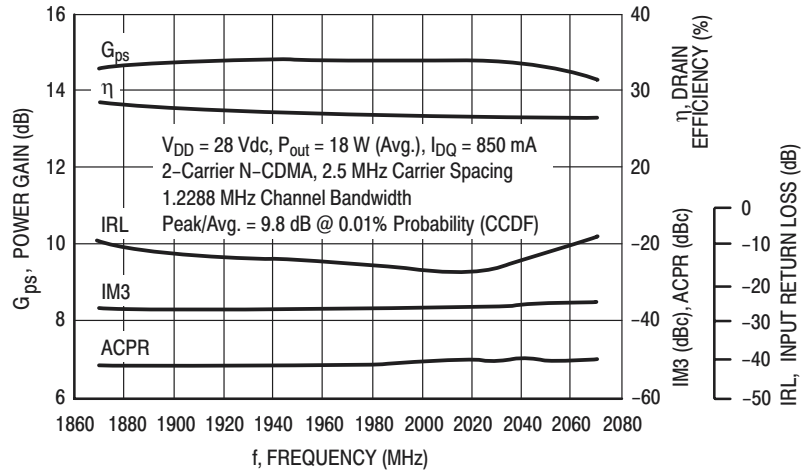

Figure 3. 2-Carrier N-CDMA Broadband Performance

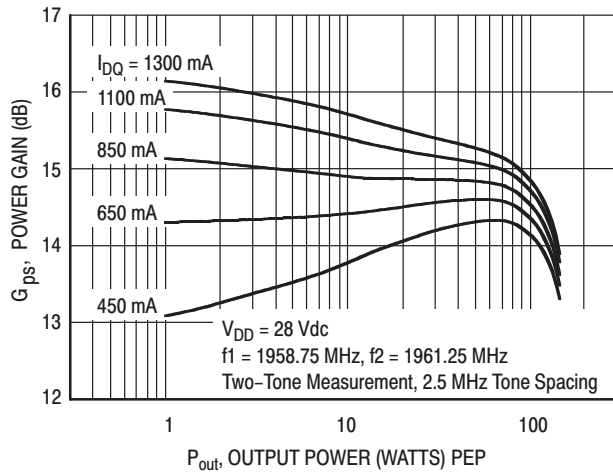

Figure 4. Two-Tone Power Gain versus Output Power

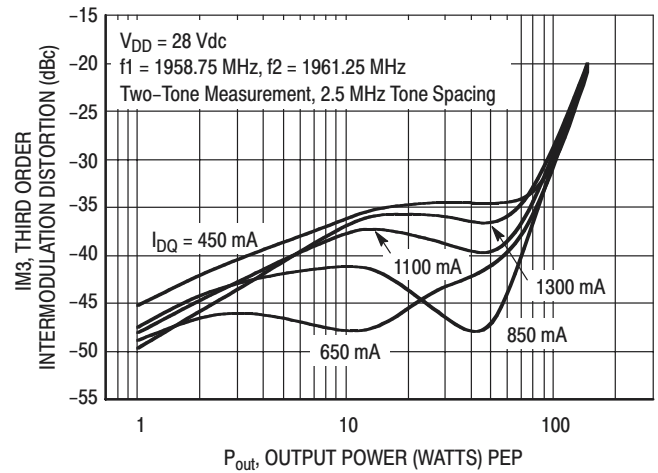

Figure 5. Third Order Intermodulation Distortion versus Output Power

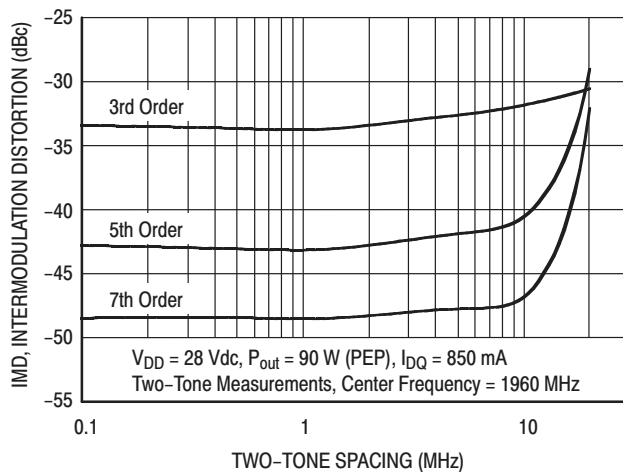

Figure 6. Intermodulation Distortion Products versus Tone Spacing

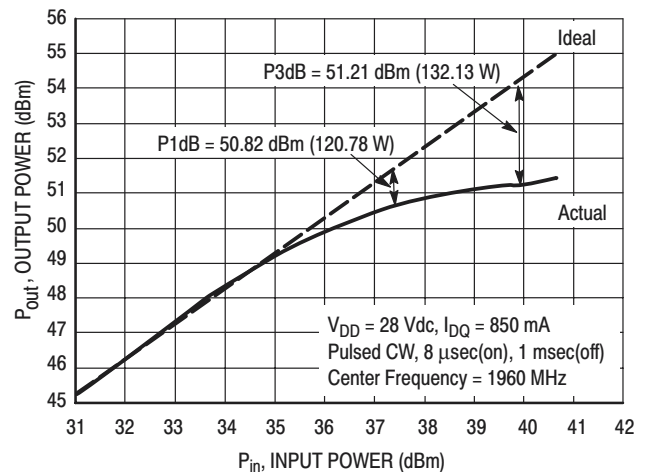

Figure 7. Pulse CW Output Power versus Input Power

## TYPICAL CHARACTERISTICS

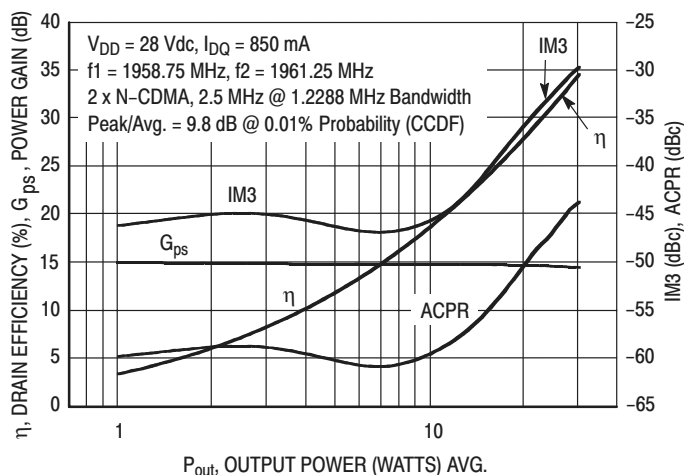

Figure 8. 2-Carrier N-CDMA ACPR, IM3, Power Gain and Drain Efficiency versus Output Power

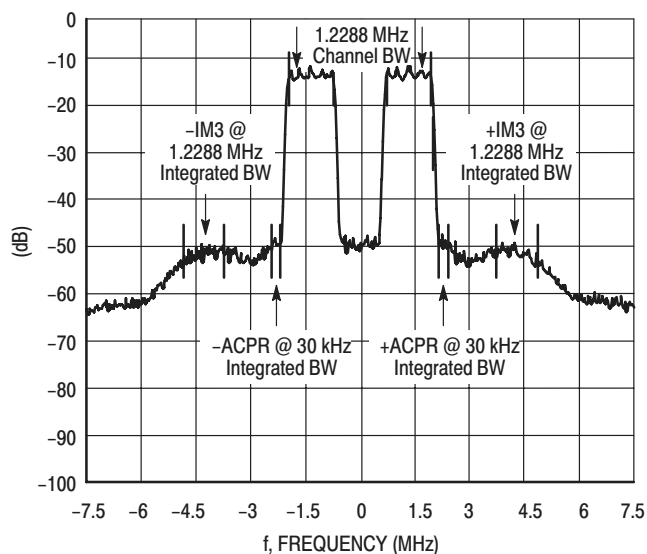
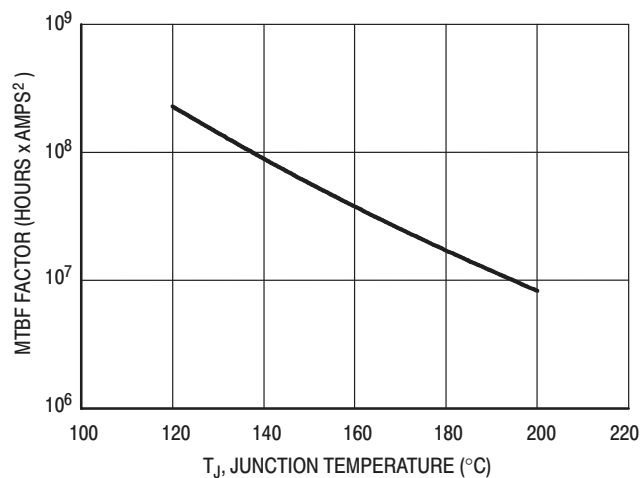
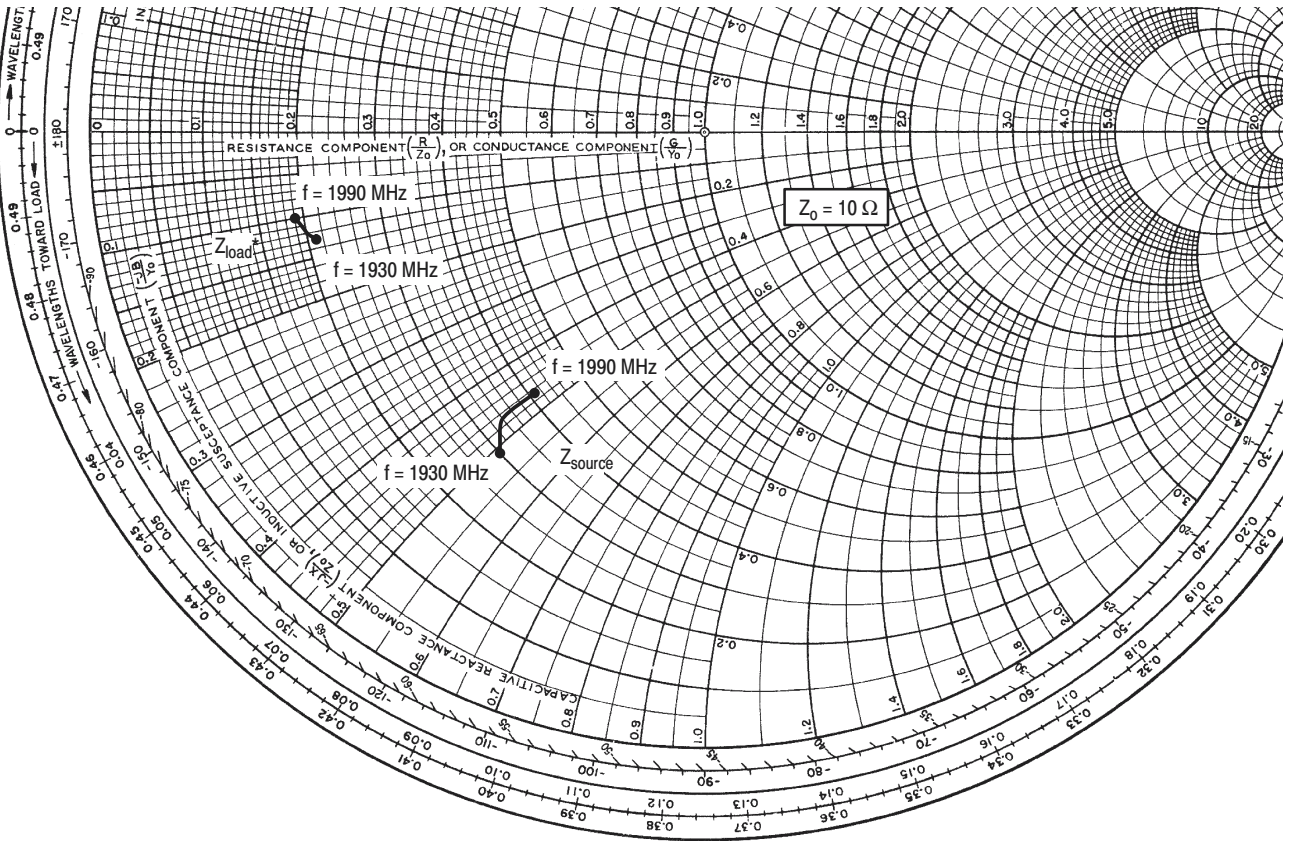

Figure 9. 2-Carrier N-CDMA Spectrum



This above graph displays calculated MTBF in hours x ampere<sup>2</sup> drain current. Life tests at elevated temperatures have correlated to better than  $\pm 10\%$  of the theoretical prediction for metal failure. Divide MTBF factor by  $I_D^2$  for MTBF in a particular application.

Figure 10. MTBF Factor versus Junction Temperature



$V_{DD} = 28\text{ V}$ ,  $I_{DQ} = 850\text{ mA}$ ,  $P_{out} = 18\text{ W Avg.}$

f MHz	$Z_{source}$ $\Omega$	$Z_{load}$ $\Omega$
1930	$2.98 - j5.12$	$2.07 - j1.31$
1960	$3.36 - j4.65$	$2.02 - j1.18$
1990	$4.06 - j4.64$	$1.93 - j1.01$

$Z_{source}$  = Test circuit impedance as measured from gate to ground.

$Z_{load}$  = Test circuit impedance as measured from drain to ground.

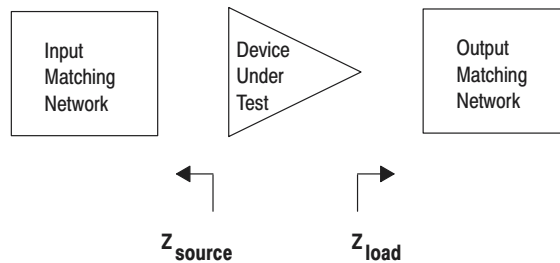

Figure 11. Series Equivalent Input and Output Impedance

# NOTES



# NOTES

# NOTES

## PACKAGE DIMENSIONS

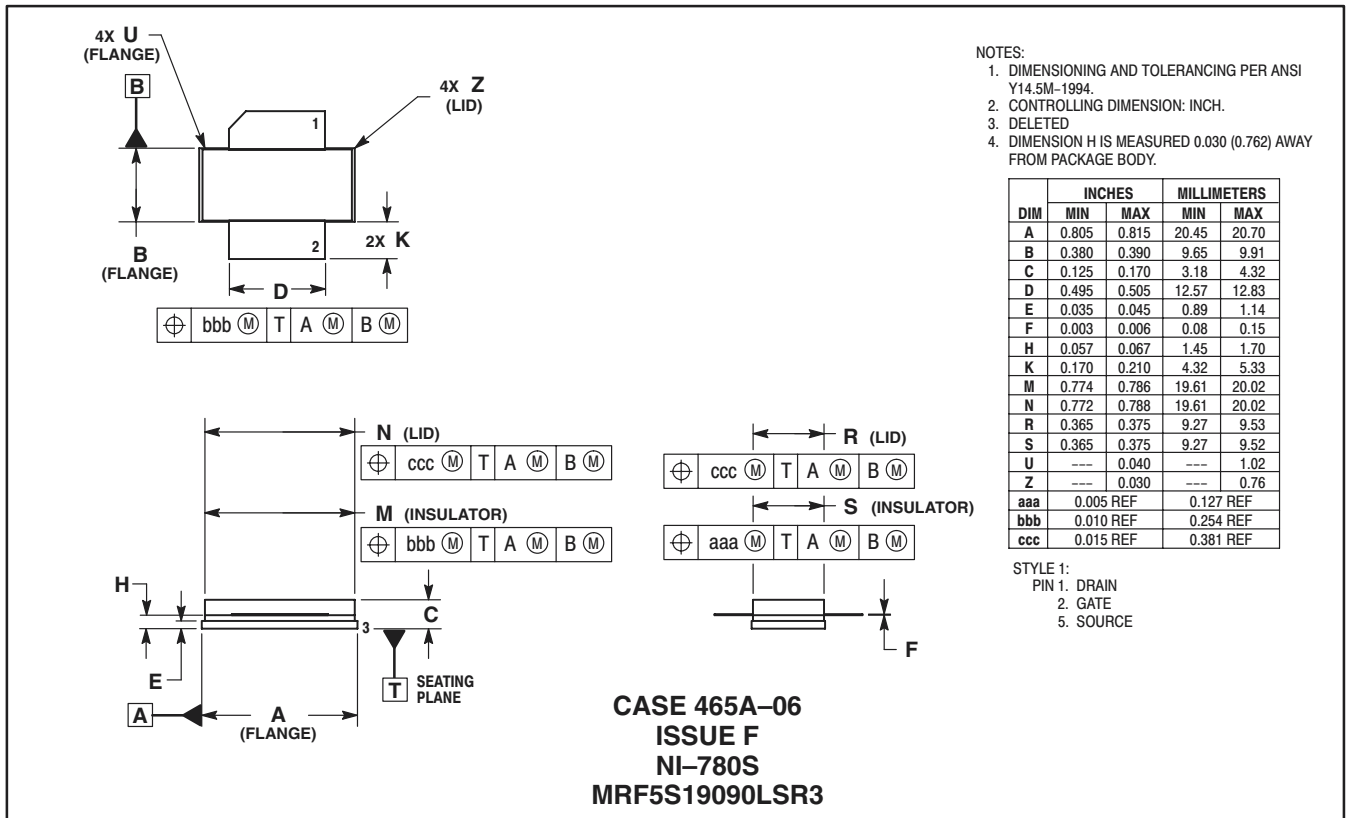
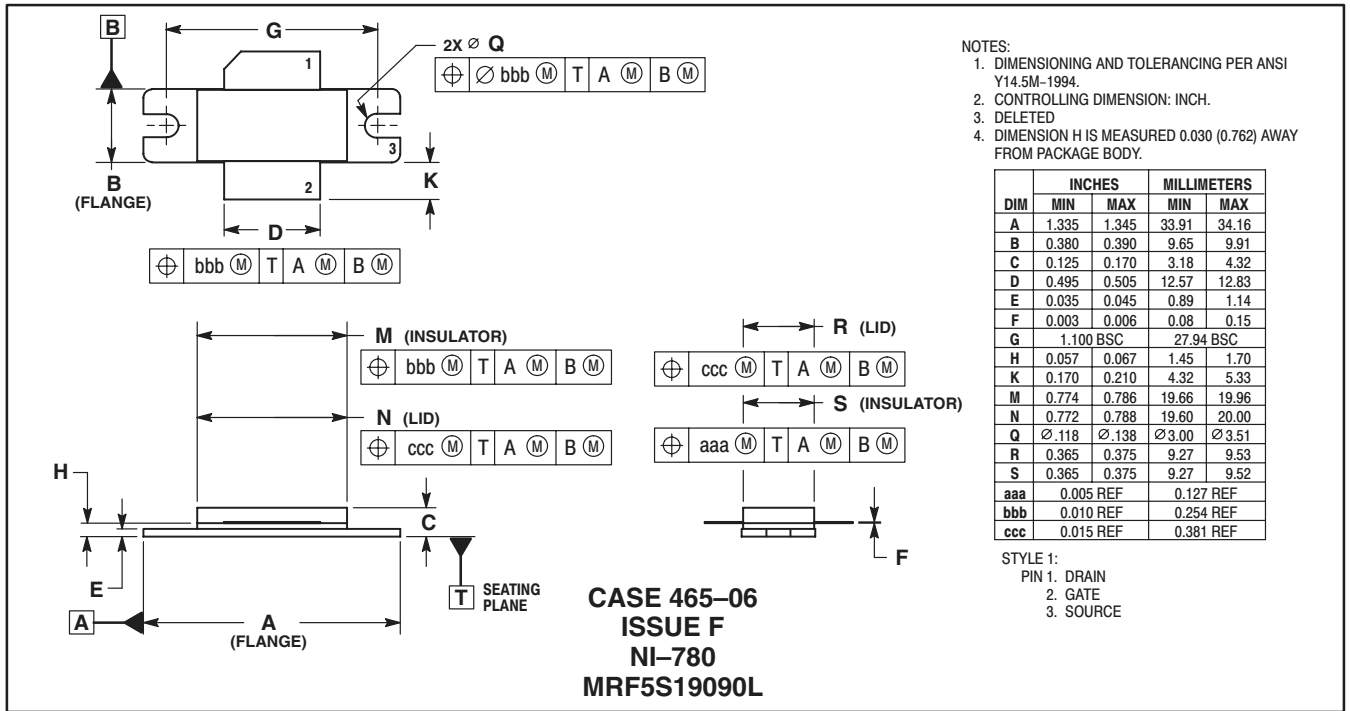

Information in this document is provided solely to enable system and software implementers to use Motorola products. There are no express or implied copyright licenses granted hereunder to design or fabricate any integrated circuits or integrated circuits based on the information in this document.

Motorola reserves the right to make changes without further notice to any products herein. Motorola makes no warranty, representation or guarantee regarding the suitability of its products for any particular purpose, nor does Motorola assume any liability arising out of the application or use of any product or circuit, and specifically disclaims any and all liability, including without limitation consequential or incidental damages. "Typical" parameters that may be provided in Motorola data sheets and/or specifications can and do vary in different applications and actual performance may vary over time. All operating parameters, including "Typicals", must be validated for each customer application by customer's technical experts. Motorola does not convey any license under its patent rights nor the rights of others. Motorola products are not designed, intended, or authorized for use as components in systems intended for surgical implant into the body, or other applications intended to support or sustain life, or for any other application in which the failure of the Motorola product could create a situation where personal injury or death may occur. Should Buyer purchase or use Motorola products for any such unintended or unauthorized application, Buyer shall indemnify and hold Motorola and its officers, employees, subsidiaries, affiliates, and distributors harmless against all claims, costs, damages, and expenses, and reasonable attorney fees arising out of, directly or indirectly, any claim of personal injury or death associated with such unintended or unauthorized use, even if such claim alleges that Motorola was negligent regarding the design or manufacture of the part.

MOTOROLA and the Stylized M Logo are registered in the US Patent and Trademark Office. All other product or service names are the property of their respective owners. Motorola, Inc. is an Equal Opportunity/Affirmative Action Employer.

© Motorola Inc. 2003

#### HOW TO REACH US:

**USA/EUROPE/LOCATIONS NOT LISTED:**  
Motorola Literature Distribution  
P.O. Box 5405, Denver, Colorado 80217  
1-800-521-6274 or 480-768-2130

**JAPAN:** Motorola Japan Ltd.; SPS, Technical Information Center,  
3-20-1, Minami-Azabu, Minato-ku, Tokyo 106-8573, Japan  
81-3-3440-3569

**ASIA/PACIFIC:** Motorola Semiconductors H.K. Ltd.; Silicon Harbour Centre,  
2 Dai King Street, Tai Po Industrial Estate, Tai Po, N.T., Hong Kong  
852-26668334

**HOME PAGE:** <http://motorola.com/semiconductors>



MRF5S19090L/D