

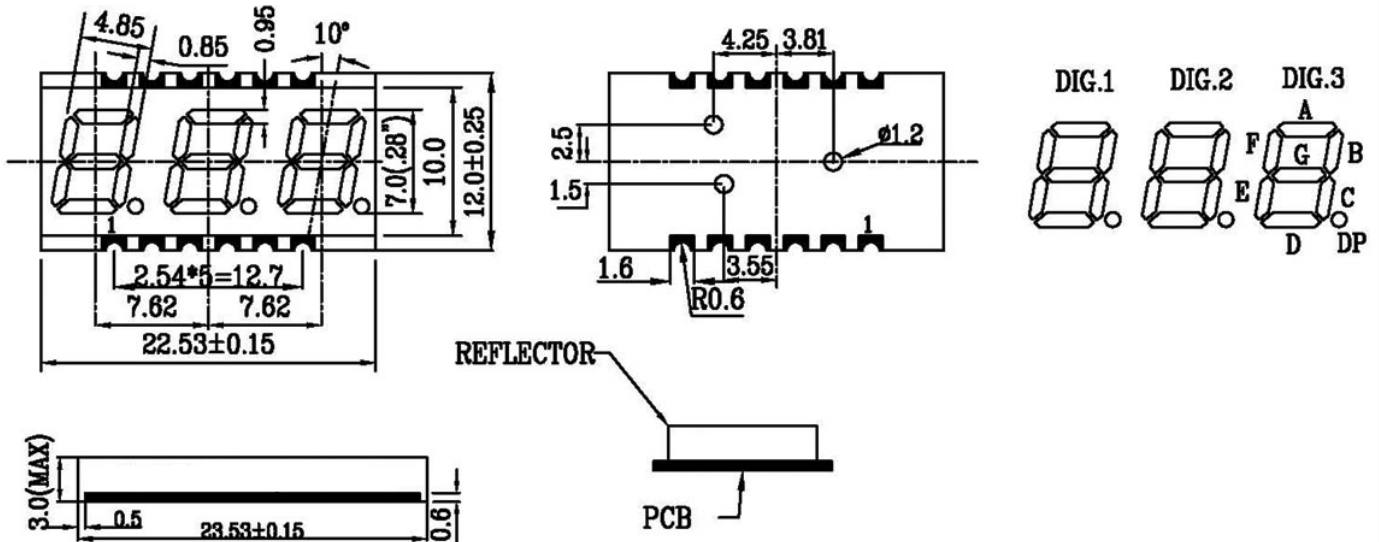

PACKAGE DIMENSIONS



NORMAL TOLERANCE:±0.10 ANGLE:±1°

INTERNAL CIRCUIT DIAGRAM

