



Film Capacitors

Metallized Polypropylene Film Capacitors (MKP)

Series/Type: B32601L ... B32602L

Date: May 2009

© EPCOS AG 2009. Reproduction, publication and dissemination of this publication, enclosures hereto and the information contained therein without EPCOS' prior express consent is prohibited.

High V AC (wound)

Typical applications

- Electronic ballasts (resonant circuits)
- SMPS
- High-frequency AC loads
- Pulse circuits

Climatic

- Max. operating temperature: 110 °C
- Climatic category (IEC 60068-1): 55/110/56

Construction

- Dielectric: metallized polypropylene (PP)
- Wound capacitor technology
- Epoxy resin coating (UL 94 V-0)

Features

- Very high AC voltages for all frequency ranges
- Very small dimensions
- High peak voltage for short time periods
- High peak current
- High pulse withstand capability

Terminals

- Crimped wire leads, lead-free tinned, lead length (6 – 1 mm) or min. 20 mm
- Double crimped wire leads, lead-free tinned
- Straight wire leads, lead-free tinned, lead length (17 ±3 mm)
- Different lead spacings available, lead length (6 – 1 mm)

Marking

Manufacturer's logo, style and type,
rated capacitance (coded),
capacitance tolerance (code letter),
rated DC voltage, date of manufacture (coded)

Delivery mode

Bulk (untaped)

Taped (Ammo pack or reel)

For notes on taping, refer to chapter "Taping and packing".

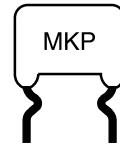

Dimensional drawings

Crimped leads

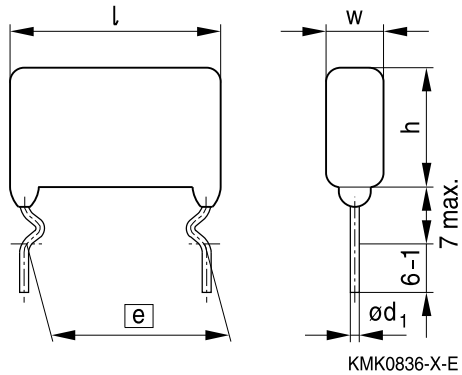

Double crimped leads

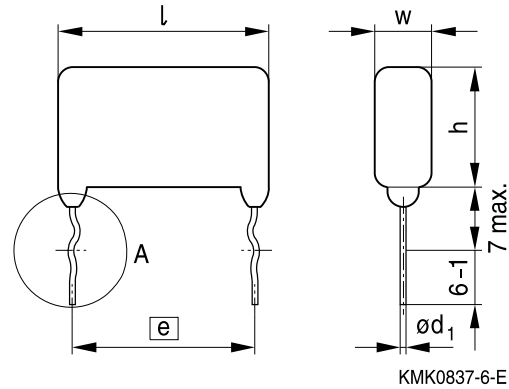

Detail of double crimped version

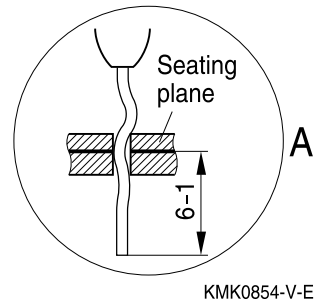

Straight leads

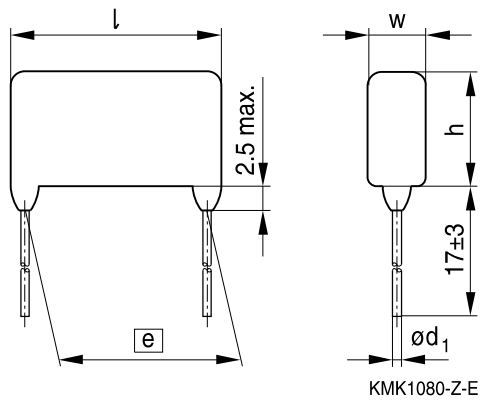

Dimensions in mm

Lead spacing	Lead diameter	Type
$e \pm 0.4$	d_1	
10	0.6	B32601L
15	0.8	B32602L

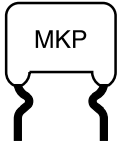

B32601L ... B32602L

High V AC (wound)

Overview of available types

Lead spacing	10 mm					15 mm						
Type	B32601L					B32602L						
Page	5					6						
V_{RMS} (V AC)	200	250	250	500	600	160	200	250	250	500	600	700
V_R (V DC)	400	630	1000	1000	1600	250	420	630	1000	1300	1600	2000
C_R (nF)												
1.0												
1.2												
1.5												
2.2												
2.7												
3.3												
3.9												
4.10												
4.7												
5.6												
6.2												
6.8												
8.2												
10												
12												
15												
22												
33												
47												
56												
68												
100												
150												
220												
330												
470												
680												
820												
1000												

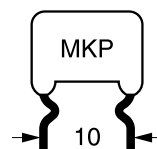
Ordering codes and packing units (lead spacing 10 mm)

V_{RMS} $f \leq 1$ kHz V AC	V_R V DC	C_R nF	Max. dimensions $w \times h \times l$ mm	Ordering code (composition see below)	Ammo pack pcs./MOQ	Reel pcs./ MOQ	Untaped pcs./ MOQ
200	400	22	$6.5 \times 11.5 \times 13.0$	B32601L4223+***	2200	4400	4000
		33	$6.5 \times 11.5 \times 13.0$	B32601L4333+***	2200	4400	4000
		47	$6.5 \times 11.5 \times 13.0$	B32601L4473+***	2200	4400	4000
		68	$7.0 \times 11.5 \times 13.0$	B32601L4683+***	2000	4000	4000
		100	$8.0 \times 12.5 \times 13.0$	B32601L4104+***	1800	3600	4000
250	630	15	$6.5 \times 11.5 \times 13.0$	B32601L6153+***	2200	4400	4000
		22	$6.5 \times 11.5 \times 13.0$	B32601L6223+***	2200	4400	4000
		33	$7.0 \times 11.5 \times 13.0$	B32601L6333+***	2000	4000	4000
		47	$7.5 \times 12.0 \times 13.0$	B32601L6473+***	2000	3800	4000
		56	$8.0 \times 12.5 \times 13.0$	B32601L6563+***	1800	3600	4000
250	1000	4.7	$6.5 \times 11.0 \times 13.0$	B32601L9472+***	2200	4400	4000
		6.8	$6.5 \times 11.0 \times 13.0$	B32601L9682+***	2200	4400	4000
		10	$6.5 \times 11.0 \times 13.0$	B32601L9103+***	2200	4400	4000
		15	$7.0 \times 12.0 \times 13.0$	B32601L9153+***	2000	4000	4000
		22	$8.0 \times 13.0 \times 13.0$	B32601L9223+***	1800	3600	4000
500	1000	3.3	$6.5 \times 11.0 \times 13.0$	B32601L0332+***	2200	4400	4000
		4.7	$6.5 \times 11.0 \times 13.0$	B32601L0472+***	2200	4400	4000
		6.8	$7.0 \times 11.5 \times 13.0$	B32601L0682+***	2000	4000	4000
		10	$8.0 \times 12.5 \times 13.0$	B32601L0103+***	1800	3600	4000
		12	$8.5 \times 13.0 \times 13.0$	B32601L0123+***	1600	3400	4000
600	1600	1.2	$6.5 \times 11.0 \times 13.0$	B32601L1122+***	2200	4400	4000
		1.5	$6.5 \times 11.0 \times 13.0$	B32601L1152+***	2200	4400	4000
		2.2	$7.0 \times 11.5 \times 13.0$	B32601L1222+***	2000	4000	4000
		3.3	$8.0 \times 12.5 \times 13.0$	B32601L1332+***	1800	3600	4000
		4.1	$8.5 \times 13.0 \times 13.0$	B32601L1412+***	1600	3400	4000

MOQ = Minimum Order Quantity, consisting of 4 packing units.
Further E series and intermediate capacitance values on request.

Composition of ordering code

+ = Capacitance tolerance code:

K = $\pm 10\%$

J = $\pm 5\%$

*** = Packaging code:

289 = Ammo pack

189 = Reel

010 = Untaped crimped (lead length 6 – 1 mm)

008 = Untaped straight (lead length 17 ± 3 mm)

020 = Double crimped (lead length 6 – 1 mm)

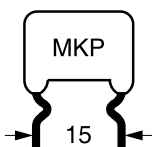
B32602L
High V AC (wound)
Ordering codes and packing units (lead spacing 15 mm)

V_{RMS} $f \leq 1$ kHz V AC	V_R V DC	C_R nF	Max. dimensions $w \times h \times l$ mm	Ordering code (composition see below)	Ammo pack pcs./MOQ	Reel pcs./ MOQ	Untaped pcs./ MOQ
160	250	150	6.5 × 11.5 × 18.0	B32602L2154+***	3400	4400	4000
		220	6.5 × 11.5 × 18.0	B32602L2224+***	3400	4400	4000
		330	7.0 × 13.0 × 18.0	B32602L2334+***	3200	4000	4000
		470	7.5 × 15.0 × 18.0	B32602L2474+***	3000	4000	4000
		680	8.5 × 16.5 × 18.0	B32602L2684+***	2600	3400	2000
		820	9.5 × 17.0 × 18.0	B32602L2824+***	2400	3200	2000
		1000	11.5 × 16.5 × 18.0	B32602L2105+***	2000	2600	2000
200	420	68	6.5 × 11.5 × 18.0	B32602L4683+***	3400	4400	4000
		100	6.5 × 11.5 × 18.0	B32602L4104+***	3400	4400	4000
		150	7.0 × 13.5 × 18.0	B32602L4154+***	3600	4000	4000
		220	8.0 × 14.5 × 18.0	B32602L4224+***	2800	3600	4000
		330	9.5 × 16.0 × 18.0	B32602L4334+***	2400	3200	2000
		470	11.5 × 17.0 × 18.0	B32602L4474+***	2000	2600	2000
250	630	33	6.5 × 11.5 × 18.0	B32602L6333+***	3400	4400	4000
		47	6.5 × 11.5 × 18.0	B32602L6473+***	3400	4400	4000
		68	7.0 × 13.0 × 18.0	B32602L6683+***	3200	4000	4000
		100	8.0 × 14.0 × 18.0	B32602L6104+***	2800	3600	4000
		150	9.0 × 15.0 × 18.0	B32602L6154+***	2400	3200	4000
		220	10.5 × 17.0 × 18.0	B32602L6224+***	2000	2600	2000
250	1000	10	6.5 × 11.5 × 18.0	B32602L0103+***	3400	4400	4000
		15	6.5 × 11.5 × 18.0	B32602L0153+***	3400	4400	4000
		22	6.5 × 11.5 × 18.0	B32602L0223+***	3400	4400	4000
		33	7.0 × 13.0 × 18.0	B32602L0333+***	3200	4000	4000
		47	7.5 × 15.0 × 18.0	B32602L0473+***	3000	4000	4000
		68	8.5 × 16.0 × 18.0	B32602L0683+***	2600	3400	2000
		100	11.0 × 17.0 × 18.0	B32602L0104+***	2000	2600	2000
500	1300	6.8	6.5 × 11.5 × 18.0	B32602L7682+***	3400	4400	4000
		10	7.0 × 11.5 × 18.0	B32602L7103+***	3200	4000	4000
		15	7.0 × 13.0 × 18.0	B32602L7153+***	3200	4000	4000
		22	8.0 × 14.0 × 18.0	B32602L7223+***	2800	3600	4000
		33	9.0 × 15.5 × 18.0	B32602L7333+***	2400	3200	2000
		47	10.5 × 17.0 × 18.0	B32602L7473+***	2000	2600	2000

MOQ = Minimum Order Quantity, consisting of 4 packing units.

Further E series and intermediate capacitance values on request.

Composition of ordering code

+ = Capacitance tolerance code:

K = ±10%

J = ±5%

*** = Packaging code:

289 = Ammo pack

189 = Reel

000 = Untaped (lead length 6 – 1 mm)

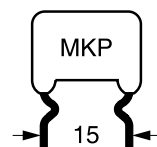
Ordering codes and packing units (lead spacing 15 mm)

V_{RMS} $f \leq 1$ kHz V AC	V_R V DC	C_R nF	Max. dimensions $w \times h \times l$ mm	Ordering code (composition see below)	Ammo pack pcs./MOQ	Reel pcs./ MOQ	Untaped pcs./ MOQ
600	1600	4.7	6.5 × 11.5 × 18.0	B32602L1472+***	3400	4400	4000
		5.6	6.5 × 11.5 × 18.0	B32602L1562+***	3400	4400	4000
		6.2	6.5 × 12.0 × 18.0	B32602L1622+***	3400	4400	4000
		6.8	6.5 × 12.5 × 18.0	B32602L1682+***	3400	4400	4000
		8.2	7.0 × 12.5 × 18.0	B32602L1822+***	3200	4000	4000
		10	7.0 × 13.5 × 18.0	B32602L1103+***	3200	4000	4000
		12	8.0 × 14.0 × 18.0	B32602L1123+***	3200	4000	4000
		15	8.5 × 14.5 × 18.0	B32602L1153+***	2600	3400	4000
		22	9.5 × 15.5 × 18.0	B32602L1223+***	2400	3200	2000
		33	12.0 × 17.0 × 18.0	B32602L1333+***	1800	2400	2000
700	2000	1.0	6.5 × 12.0 × 18.0	B32602L8102+***	3400	4400	4000
		1.2	6.5 × 12.0 × 18.0	B32602L8122+***	3400	4400	4000
		1.5	6.5 × 12.0 × 18.0	B32602L8152+***	3400	4400	4000
		2.2	7.0 × 12.0 × 18.0	B32602L8222+***	3200	4000	4000
		2.7	7.0 × 12.0 × 18.0	B32602L8272+***	3200	4000	4000
		3.3	7.0 × 12.0 × 18.0	B32602L8332+***	3200	4000	4000
		3.9	7.0 × 12.0 × 18.0	B32602L8392+***	3200	4000	4000
		4.1	7.0 × 12.0 × 18.0	B32602L8412+***	3200	4000	4000
		4.7	7.0 × 12.0 × 18.0	B32602L8472+***	3200	4000	4000
		5.6	7.0 × 12.5 × 18.0	B32602L8562+***	3200	4000	4000
		6.2	7.0 × 13.0 × 18.0	B32602L8622+***	3200	4000	4000
		6.8	7.0 × 13.5 × 18.0	B32602L8682+***	3200	4000	4000
		8.2	7.5 × 14.0 × 18.0	B32602L8822+***	3000	4000	4000
		10	8.5 × 14.5 × 18.0	B32602L8103+***	2600	3400	4000
		12	9.0 × 15.0 × 18.0	B32602L8123+***	2400	3200	4000
15	9.5 × 16.0 × 18.0	B32602L8153+***	2400	3200	2000		
		22	11.5 × 17.0 × 18.0	B32602L8223+***	2000	2600	2000

MOQ = Minimum Order Quantity, consisting of 4 packing units.

Further E series and intermediate capacitance values on request.

Composition of ordering code

+ = Capacitance tolerance code:

K = ±10%

J = ±5%

*** = Packaging code:

289 = Ammo pack

189 = Reel

000 = Untaped (lead length 6 – 1 mm)

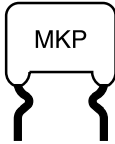

B32601L ... B32602L

High V AC (wound)

Technical data

Operating temperature range	Upper category temperature T_{max}		+110 °C		
	Lower category temperature T_{min}		-55 °C		
	Rated temperature T_R		+85 °C		
Dissipation factor $\tan \delta$ (in 10^{-3}) at 20 °C (upper limit values)	at	$C_R \leq 27 \text{ nF}$	$27 \text{ nF} < C_R \leq 0.1 \mu\text{F}$	$0.1 \mu\text{F} < C_R \leq 0.1 \mu\text{F}$	$C_R > 1 \mu\text{F}$
	1 kHz	0.8	0.8	0.8	0.8
	10 kHz	1.0	1.0	1.0	—
	100 kHz	2.0	3.0	—	—
Insulation resistance R_{ins} or time constant $\tau = C_R \cdot R_{ins}$ at 20 °C, rel. humidity $\leq 65\%$ (minimum as-delivered values)	$C_R \leq 0.33 \mu\text{F}$		$C_R > 0.33 \mu\text{F}$		
	100 G Ω		30000 s		
DC test voltage	$1.6 \cdot V_R, 2 \text{ s}$				
Category voltage V_C (continuous operation with V_{DC} or V_{AC} at $f \leq 1 \text{ kHz}$)	T_A (°C)	DC voltage derating		AC voltage derating	
	$T_A \leq 85$ $85 < T_A \leq 110$	$V_C = V_R$ $V_C = V_R \cdot (165 - T_A) / 80$		$V_{C,RMS} = V_{RMS}$ $V_{C,RMS} = V_{RMS} \cdot (165 - T_A) / 80$	
Operating voltage V_{op} for short operating periods (V_{DC} or V_{AC} at $f \leq 1 \text{ kHz}$)	T_A (°C)	DC voltage (max. hours)		AC voltage (max. hours)	
	$T_A \leq 100$ $100 < T_A \leq 110$	$V_{op} = 1.25 \cdot V_C$ (2000 h) $V_{op} = 1.25 \cdot V_C$ (1000 h)		$V_{op} = 1.0 \cdot V_{C,RMS}$ (2000 h) $V_{op} = 1.0 \cdot V_{C,RMS}$ (1000 h)	
Damp heat test Limit values after damp heat test	56 days/40 °C/93% relative humidity				
	Capacitance change $ \Delta C/C $		$\leq 2\%$		
	Dissipation factor change $\Delta \tan \delta$		$\leq 1.0 \cdot 10^{-3}$ (at 1 kHz)		
	Insulation resistance R_{ins}		$\geq 50 \text{ G}\Omega$		
Reliability: Failure rate λ Service life t_{SL}	1 fit ($\leq 1 \cdot 10^{-9}/\text{h}$) at $0.5 \cdot V_R, 40 \text{ °C}$ 200 000 h at $1.0 \cdot V_R, 85 \text{ °C}$ For conversion to other operating conditions and temperatures, refer to chapter "Quality, 2 Reliability".				
Failure criteria: Total failure	Short circuit or open circuit				
Failure due to variation of parameters	Capacitance change $ \Delta C/C $		$> 10\%$		
	Dissipation factor $\tan \delta$		$> 4 \cdot$ upper limit values		
	Insulation resistance R_{ins}		$< 1500 \text{ M}\Omega$		

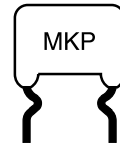

Pulse handling capability

"dV/dt" represents the maximum permissible voltage change per unit of time for non-sinusoidal voltages, expressed in V/ μ s.

"k₀" represents the maximum permissible pulse characteristic of the waveform applied to the capacitor, expressed in V²/ μ s.

Note:

The values of dV/dt and k₀ provided below must not be exceeded in order to avoid damaging the capacitor.

dV/dt values

Lead spacing		10 mm	15 mm
V _R V DC	V _{RMS} V AC	dV/dt in V/ μ s	
250	160	–	170
400	200	400	200
630	250	540	300
1000	250	810	445
1000	500	–	–
1300	500	–	1000
1600	600	–	–
2000	700	–	–

k₀ values

Lead spacing		10 mm	15 mm
V _R V DC	V _{RMS} V AC	dV/dt in V/ μ s	
250	160	–	100 000
400	200	150 000	120 000
630	250	200 000	500 000
1000	250	400 000	1 000 000
1000	500	–	–
1300	500	–	3 000 000
1600	600	–	–
2000	700	–	–

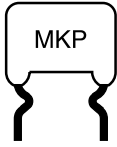

B32601L ... B32602L

High V AC (wound)

Impedance Z versus frequency f
(typical values)

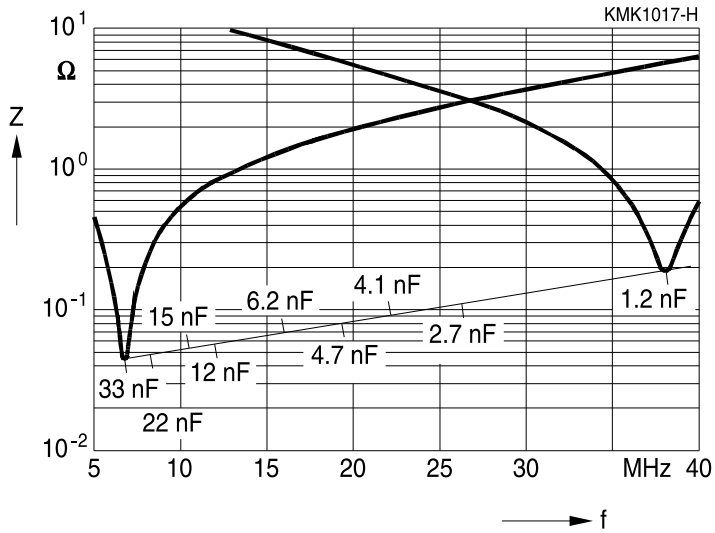

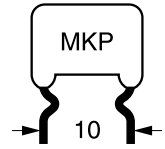

Permissible AC voltage V_{RMS} versus frequency f (for sinusoidal waveforms $T_A \leq 100\text{ }^\circ\text{C}$)
 For $T_A > 100\text{ }^\circ\text{C}$, please refer to "General technical information", section 3.2.3.

Lead spacing 10 mm

400 V DC/200 V AC

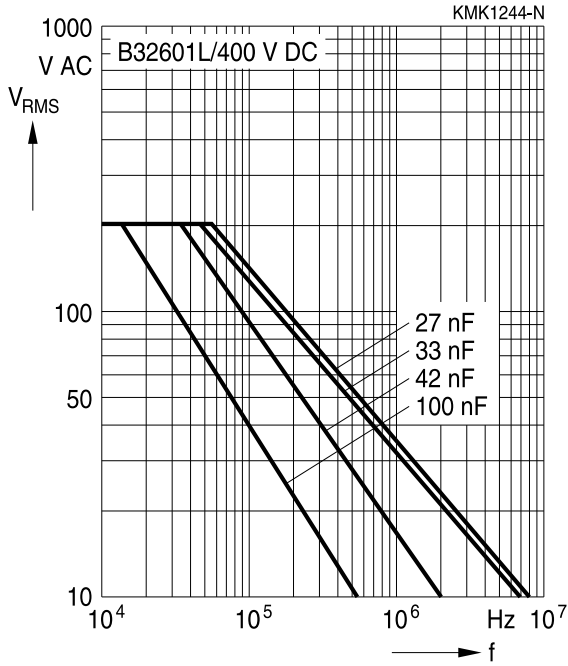

630 V DC/250 V AC

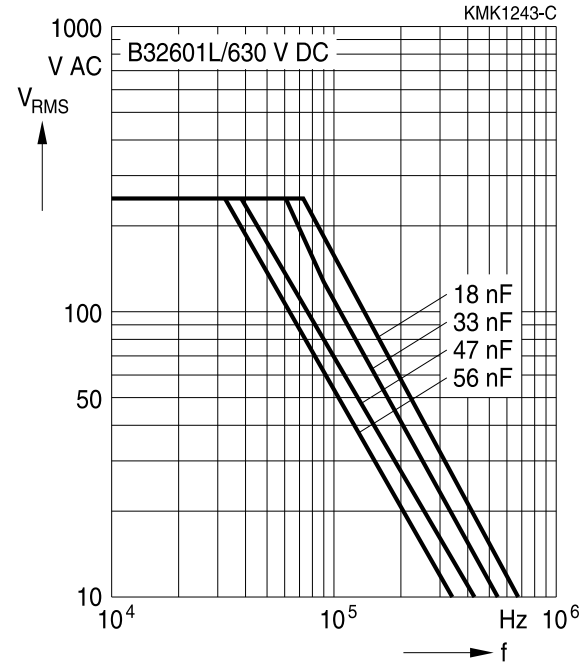

1000 V DC/250 V AC

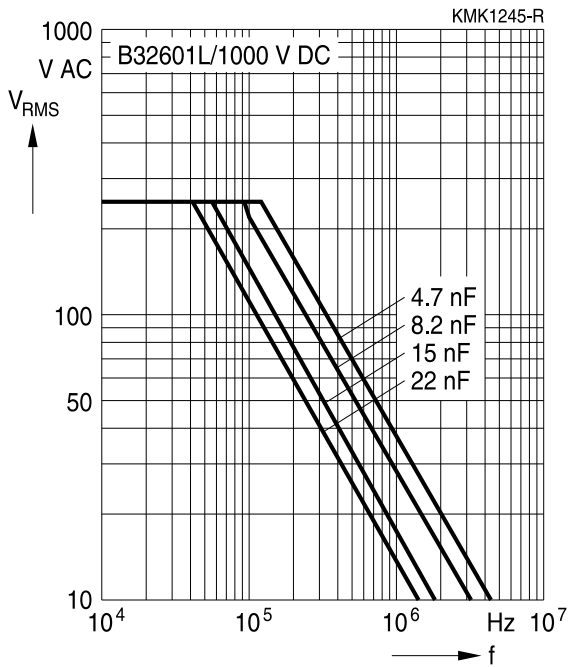

1000 V DC/500 V AC

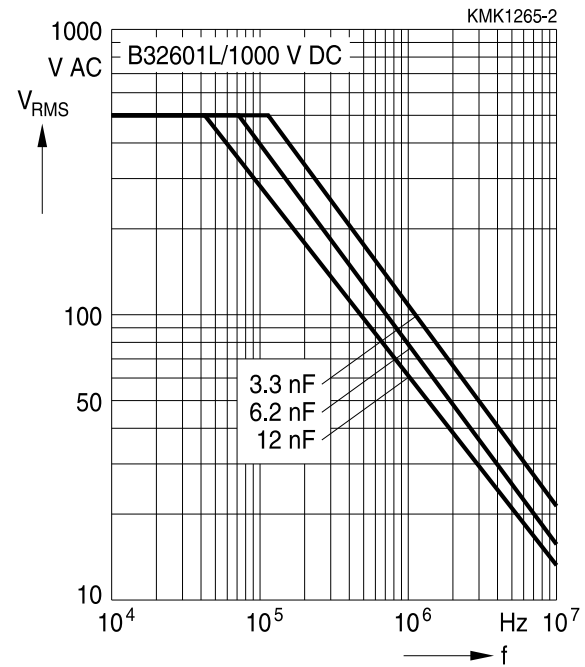

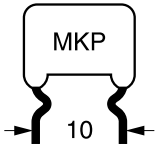

B32601L

High V AC (wound)

Permissible AC voltage V_{RMS} versus frequency f (for sinusoidal waveforms $T_A \leq 100\text{ }^\circ\text{C}$)

For $T_A > 100\text{ }^\circ\text{C}$, please refer to "General technical information", section 3.2.3.

Lead spacing 10 mm

1600 V DC/600 V AC

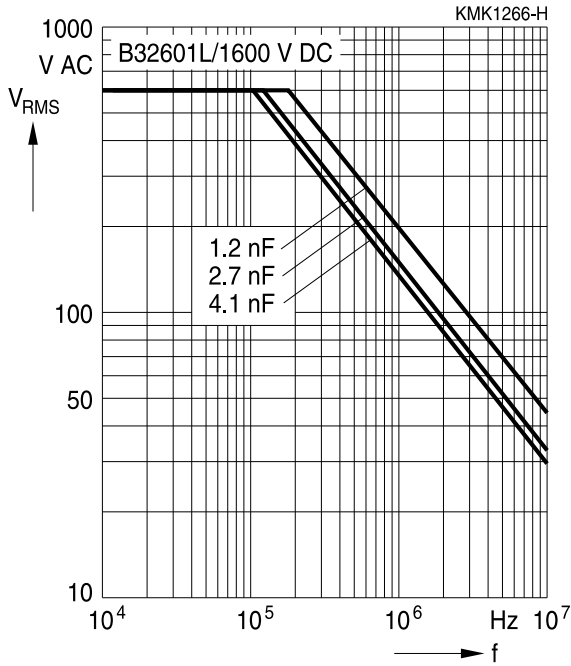

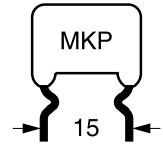

Permissible AC voltage V_{RMS} versus frequency f (for sinusoidal waveforms $T_A \leq 100\text{ }^\circ\text{C}$)
 For $T_A > 100\text{ }^\circ\text{C}$, please refer to "General technical information", section 3.2.3.

Lead spacing 15 mm

250 V DC/160 V AC

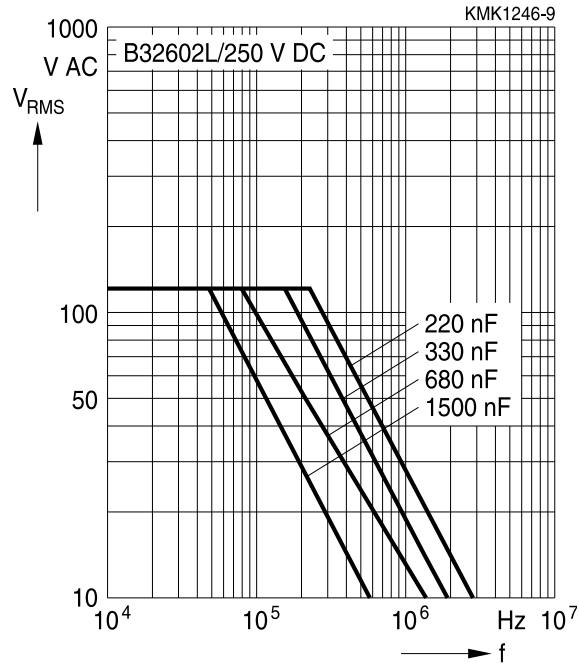

420 V DC/200 V AC

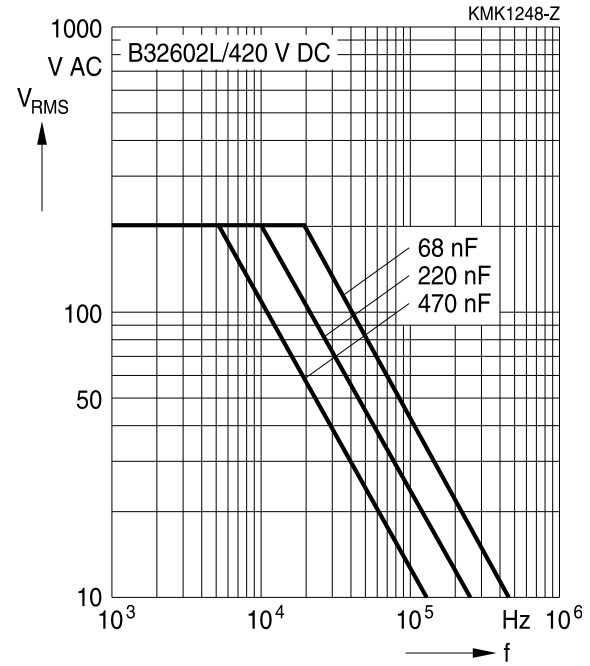

630 V DC/250 V AC

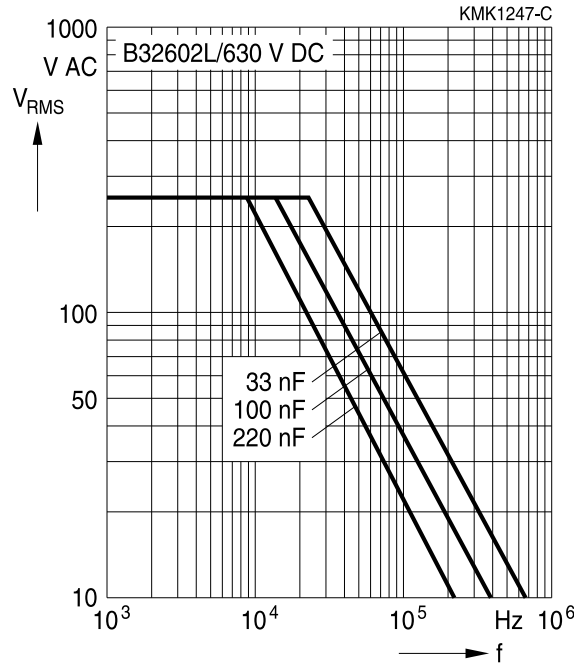

1000 V DC/250 V AC

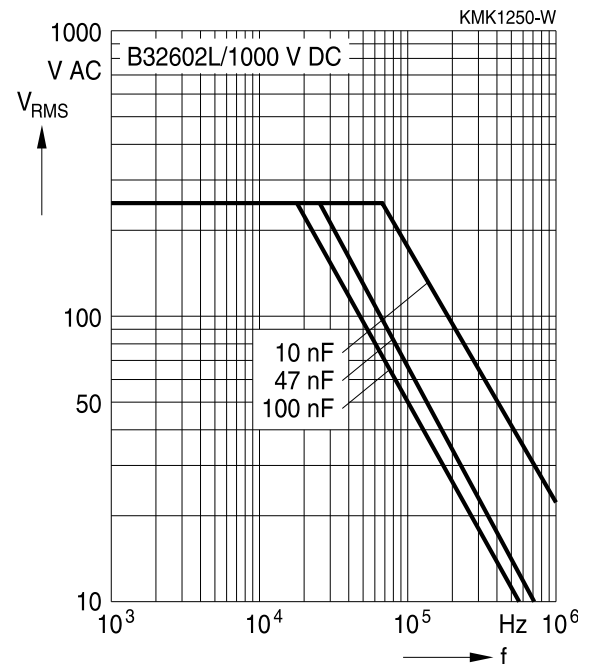

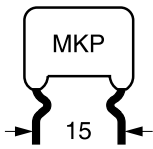

B32602L

High V AC (wound)

Permissible AC voltage V_{RMS} versus frequency f (for sinusoidal waveforms $T_A \leq 100\text{ }^\circ\text{C}$)
 For $T_A > 100\text{ }^\circ\text{C}$, please refer to "General technical information", section 3.2.3.

Lead spacing 15 mm

1300 V DC/500 V AC

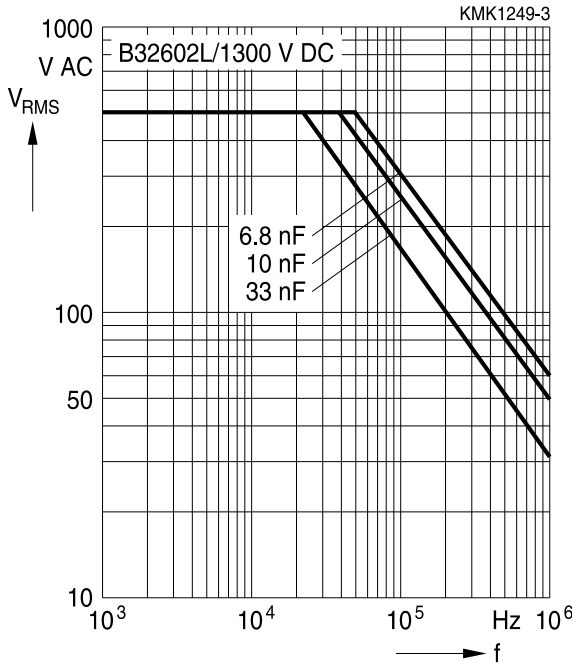

1600 V DC/600 V AC

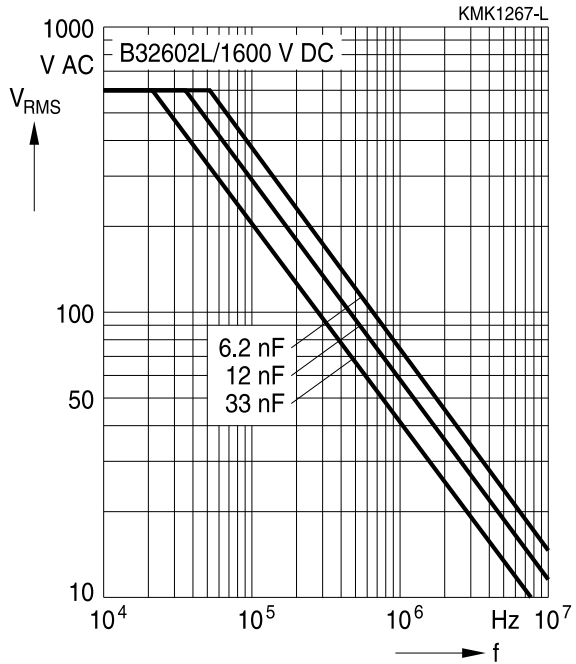

2000 V DC/700 V AC

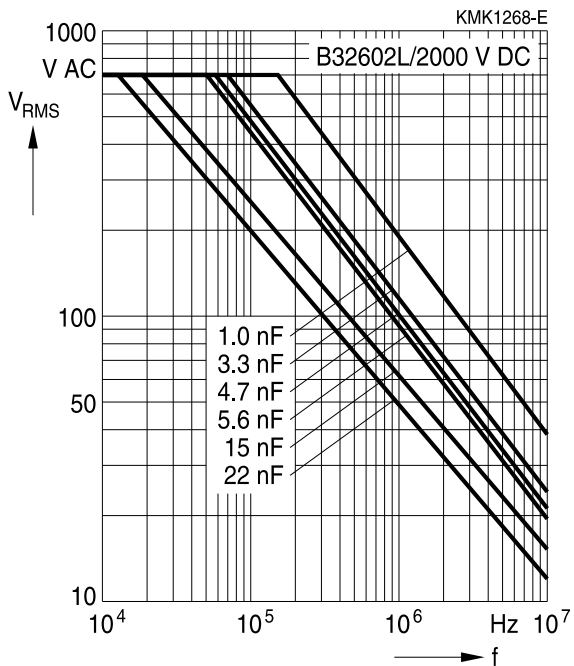

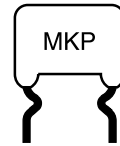

Mounting guidelines

1 Soldering

1.1 Solderability of leads

The solderability of terminal leads is tested to IEC 60068-2-20, test Ta, method 1.

Before a solderability test is carried out, terminals are subjected to accelerated ageing (to IEC 60068-2-2, test Ba: 4 h exposure to dry heat at 155 °C). Since the ageing temperature is far higher than the upper category temperature of the capacitors, the terminal wires should be cut off from the capacitor before the ageing procedure to prevent the solderability being impaired by the products of any capacitor decomposition that might occur.

Solder bath temperature	235 ±5 °C
Soldering time	2.0 ±0.5 s
Immersion depth	2.0 +0/-0.5 mm from capacitor body or seating plane
Evaluation criteria: Visual inspection	Wetting of wire surface by new solder ≥90%, free-flowing solder

1.2 Resistance to soldering heat

Resistance to soldering heat is tested to IEC 60068-2-20, test Tb, method 1A.

Conditions:

Series	Solder bath temperature	Soldering time
MKT boxed (except 2.5 × 6.5 × 7.2 mm) coated uncoated (lead spacing > 10 mm)	260 ±5 °C	10 ±1 s
MFP MKP (lead spacing > 7.5 mm)		
MKT boxed (case 2.5 × 6.5 × 7.2 mm)		5 ±1 s
MKT (lead spacing ≤ 7.5 mm)		< 4 s
MKT uncoated (lead spacing ≤ 10 mm) insulated (B32559)		recommended soldering profile for MKT uncoated (lead spacing ≤ 10 mm) and insulated (B32559)

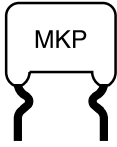

B32601L ... B32602L

High V AC (wound)

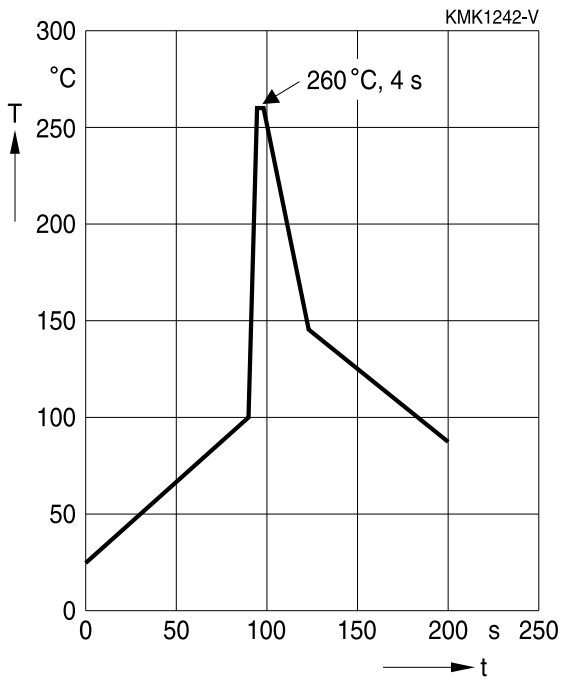

Immersion depth	2.0 +0/-0.5 mm from capacitor body or seating plane
Shield	Heat-absorbing board, (1.5 ±0.5) mm thick, between capacitor body and liquid solder
Evaluation criteria:	
Visual inspection	No visible damage
$\Delta C/C_0$	2% for MKT/MKP/MFP 5% for EMI suppression capacitors
$\tan \delta$	As specified in sectional specification

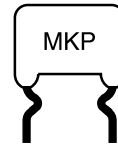

1.3 General notes on soldering

Permissible heat exposure loads on film capacitors are primarily characterized by the upper category temperature T_{\max} . Long exposure to temperatures above this type-related temperature limit can lead to changes in the plastic dielectric and thus change irreversibly a capacitor's electrical characteristics. For short exposures (as in practical soldering processes) the heat load (and thus the possible effects on a capacitor) will also depend on other factors like:

- Pre-heating temperature and time
- Forced cooling immediately after soldering
- Terminal characteristics:
diameter, length, thermal resistance, special configurations (e.g. crimping)
- Height of capacitor above solder bath
- Shadowing by neighboring components
- Additional heating due to heat dissipation by neighboring components
- Use of solder-resist coatings

The overheating associated with some of these factors can usually be reduced by suitable countermeasures. For example, if a pre-heating step cannot be avoided, an additional or reinforced cooling process may possibly have to be included.

EPCOS recommends the following conditions:

- Pre-heating with a maximum temperature of 110 °C
- Temperature inside the capacitor should not exceed the following limits:
 - MKP/MFP 110 °C
 - MKT 160 °C
- When SMD components are used together with leaded ones, the leaded film capacitors should not pass into the SMD adhesive curing oven. The leaded components should be assembled after the SMD curing step.
- Leaded film capacitors are not suitable for reflow soldering.

Uncoated capacitors

For uncoated MKT capacitors with lead spacings ≤ 10 mm (B32560/B32561) the following measures are recommended:

- pre-heating to not more than 110 °C in the preheater phase
- rapid cooling after soldering

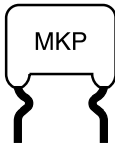

B32601L ... B32602L

High V AC (wound)

2 Cleaning

To determine whether the following solvents, often used to remove flux residues and other substances, are suitable for the capacitors described, refer to the table below:

Type	Ethanol, isopropanol, n-propanol	n-propanol-water mixtures, water with surface tension-reducing tensides (neutral)	Solvent from table A (see next page)	Solvent from table B (see next page)
MKT (uncoated)	Suitable	Unsuitable	In part suitable	Unsuitable
MKT, MKP, MFP (coated/boxed)		Suitable	Suitable	

Even when suitable solvents are used, a reversible change of the electrical characteristics may occur in uncoated capacitors immediately after they are washed. Thus it is always recommended to dry the components (e.g. 4 h at 70 °C) before they are subjected to subsequent electrical testing.

Table A

Manufacturers' designations for trifluoro-trichloro-ethane-based cleaning solvents (selection)

Trifluoro-trichloro-ethane	Mixtures of trifluoro-trichloro-ethane with ethanol and isopropanol	Manufacturer
Freon TF	Freon TE 35; Freon TP 35; Freon TES	Du Pont
Frigen 113 TR	Frigen 113 TR-E; Frigen 113 TR-P; Frigen TR-E 35	Hoechst
Arklone P	Arklone A; Arklone L; Arklone K	ICI
Kaltron 113 MDR	Kaltron 113 MDA; Kaltron 113 MDI; Kaltron 113 MDI 35	Kali-Chemie
Flugene 113	Flugene 113 E; Flugene 113 IPA	Rhone-Progil

Table B (worldwide banned substances)

Manufacturers' designations for unsuitable cleaning solvents (selection)

Mixtures of chlorinated hydrocarbons and ketones with fluorated hydrocarbons	Manufacturer
Freon TMC; Freon TA; Freon TC	Du Pont
Arklone E	ICI
Kaltron 113 MDD; Kaltron 113 MDK	Kali-Chemie
Flugene 113 CM	Rhone-Progil

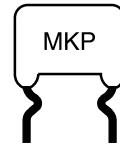

3 Embedding of capacitors in finished assemblies

In many applications, finished circuit assemblies are embedded in plastic resins. In this case, both chemical and thermal influences of the embedding ("potting") and curing processes must be taken into account.

Our experience has shown that the following potting materials can be recommended: non-flexible epoxy resins with acid-anhydride hardeners; chemically inert, non-conducting fillers; maximum curing temperature of 100 °C.

Caution:

Consult us first if you wish to embed uncoated types!

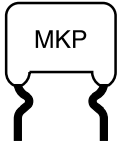

B32601L ... B32602L

High V AC (wound)

Cautions and warnings

- Do not exceed the upper category temperature (UCT).
- Do not apply any mechanical stress to the capacitor terminals.
- Avoid any compressive, tensile or flexural stress.
- Do not move the capacitor after it has been soldered to the PC board.
- Do not pick up the PC board by the soldered capacitor.
- Do not place the capacitor on a PC board whose PTH hole spacing differs from the specified lead spacing.
- Do not exceed the specified time or temperature limits during soldering.
- Avoid external energy inputs, such as fire or electricity.
- Avoid overload of the capacitors.

The table below summarizes the safety instructions that must always be observed. A detailed description can be found in the relevant sections of the chapters "General technical information" and "Mounting guidelines".

Topic	Safety information	Reference chapter "General technical information"
Storage conditions	Make sure that capacitors are stored within the specified range of time, temperature and humidity conditions.	4.5 "Storage conditions"
Flammability	Avoid external energy, such as fire or electricity (passive flammability), avoid overload of the capacitors (active flammability) and consider the flammability of materials.	5.3 "Flammability"
Resistance to vibration	Do not exceed the tested ability to withstand vibration. The capacitors are tested to IEC 60068-2-6. EPCOS offers film capacitors specially designed for operation under more severe vibration regimes such as those found in automotive applications. Consult our catalog "Film Capacitors for Automotive Electronics".	5.2 "Resistance to vibration"

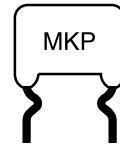

Topic	Safety information	Reference chapter "Mounting guidelines"
Soldering	Do not exceed the specified time or temperature limits during soldering.	1 "Soldering"
Cleaning	Use only suitable solvents for cleaning capacitors.	2 "Cleaning"
Embedding of capacitors in finished assemblies	When embedding finished circuit assemblies in plastic resins, chemical and thermal influences must be taken into account. Caution: Consult us first, if you also wish to embed other uncoated component types!	3 "Embedding of capacitors in finished assemblies"

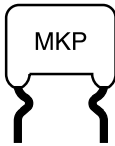

B32601L ... B32602L

High V AC (wound)

Symbols and terms

Symbol	English	German
α	Heat transfer coefficient	Wärmeübergangszahl
α_C	Temperature coefficient of capacitance	Temperaturkoeffizient der Kapazität
A	Capacitor surface area	Kondensatoroberfläche
β_C	Humidity coefficient of capacitance	Feuchtekoeffizient der Kapazität
C	Capacitance	Kapazität
C_R	Rated capacitance	Nennkapazität
ΔC	Absolute capacitance change	Absolute Kapazitätsänderung
$\Delta C/C$	Relative capacitance change (relative deviation of actual value)	Relative Kapazitätsänderung (relative Abweichung vom Ist-Wert)
$\Delta C/C_R$	Capacitance tolerance (relative deviation from rated capacitance)	Kapazitätstoleranz (relative Abweichung vom Nennwert)
dt	Time differential	Differentielle Zeit
Δt	Time interval	Zeitintervall
ΔT	Absolute temperature change (self-heating)	Absolute Temperaturänderung (Selbsterwärmung)
$\Delta \tan \delta$	Absolute change of dissipation factor	Absolute Änderung des Verlustfaktors
ΔV	Absolute voltage change	Absolute Spannungsänderung
dV/dt	Time differential of voltage function (rate of voltage rise)	Differentielle Spannungsänderung (Spannungsflankensteilheit)
$\Delta V/\Delta t$	Voltage change per time interval	Spannungsänderung pro Zeitintervall
E	Activation energy for diffusion	Aktivierungsenergie zur Diffusion
ESL	Self-inductance	Eigeninduktivität
ESR	Equivalent series resistance	Ersatz-Serienwiderstand
f	Frequency	Frequenz
f_1	Frequency limit for reducing permissible AC voltage due to thermal limits	Grenzfrequenz für thermisch bedingte Reduzierung der zulässigen Wechselspannung
f_2	Frequency limit for reducing permissible AC voltage due to current limit	Grenzfrequenz für strombedingte Reduzierung der zulässigen Wechselspannung
f_r	Resonant frequency	Resonanzfrequenz
F_D	Thermal acceleration factor for diffusion	Therm. Beschleunigungsfaktor zur Diffusion
F_T	Derating factor	Deratingfaktor
i	Current (peak)	Stromspitze
I_C	Category current (max. continuous current)	Kategoriestrom (max. Dauerstrom)

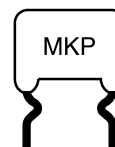

Symbol	English	German
I_{RMS}	(Sinusoidal) alternating current, root-mean-square value	(Sinusförmiger) Wechselstrom
i_z	Capacitance drift	Inkonstanz der Kapazität
k_0	Pulse characteristic	Impuls kennwert
L_S	Series inductance	Serieninduktivität
λ	Failure rate	Ausfallrate
λ_0	Constant failure rate during useful service life	Konstante Ausfallrate in der Nutzungsphase
λ_{test}	Failure rate, determined by tests	Experimentell ermittelte Ausfallrate
P_{diss}	Dissipated power	Abgegebene Verlustleistung
P_{gen}	Generated power	Erzeugte Verlustleistung
Q	Heat energy	Wärmeenergie
ρ	Density of water vapor in air	Dichte von Wasserdampf in Luft
R	Universal molar constant for gases	Allg. Molarkonstante für Gas
R	Ohmic resistance of discharge circuit	Ohmscher Widerstand des Entladekreises
R_i	Internal resistance	Innenwiderstand
R_{ins}	Insulation resistance	Isolationswiderstand
R_p	Parallel resistance	Parallelwiderstand
R_S	Series resistance	Serienwiderstand
S	severity (humidity test)	Schärfegrad (Feuchtetest)
t	Time	Zeit
T	Temperature	Temperatur
τ	Time constant	Zeitkonstante
$\tan \delta$	Dissipation factor	Verlustfaktor
$\tan \delta_D$	Dielectric component of dissipation factor	Dielektrischer Anteil des Verlustfaktors
$\tan \delta_P$	Parallel component of dissipation factor	Parallelanteil des Verlustfaktors
$\tan \delta_S$	Series component of dissipation factor	Serienanteil des Verlustfaktors
T_A	Ambient temperature	Umgebungstemperatur
T_{max}	Upper category temperature	Obere Kategorietemperatur
T_{min}	Lower category temperature	Untere Kategorietemperatur
t_{OL}	Operating life at operating temperature and voltage	Betriebszeit bei Betriebstemperatur und -spannung
T_{op}	Operating temperature	Betriebstemperatur
T_R	Rated temperature	Nenntemperatur
T_{ref}	Reference temperature	Referenztemperatur
t_{SL}	Reference service life	Referenz-Lebensdauer
V_{AC}	AC voltage	Wechselspannung

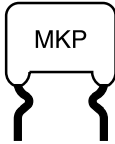

B32601L ... B32602L

High V AC (wound)

Symbol	English	German
V_C	Category voltage	Kategoriespannung
$V_{C,RMS}$	Category AC voltage	(Sinusförmige) Kategorie-Wechselspannung
V_{CD}	Corona-discharge onset voltage	Teilentlade-Einsatzspannung
V_{ch}	Charging voltage	Ladespannung
V_{DC}	DC voltage	Gleichspannung
V_{FB}	Fly-back capacitor voltage	Spannung (Flyback)
V_i	Input voltage	Eingangsspannung
V_o	Output voltage	Ausgangsspannung
V_{op}	Operating voltage	Betriebsspannung
V_p	Peak pulse voltage	Impuls-Spitzenspannung
V_{pp}	Peak-to-peak voltage Impedance	Spannungshub
V_R	Rated voltage	Nennspannung
\hat{V}_R	Amplitude of rated AC voltage	Amplitude der Nenn-Wechselspannung
V_{RMS}	(Sinusoidal) alternating voltage, root-mean-square value	(Sinusförmige) Wechselspannung
V_{SC}	S-correction voltage	Spannung bei Anwendung "S-correction"
V_{sn}	Snubber capacitor voltage	Spannung bei Anwendung "Beschaltung"
Z	Impedance	Scheinwiderstand
e	Lead spacing	Rastermaß

Important notes

The following applies to all products named in this publication:

1. Some parts of this publication contain **statements about the suitability of our products for certain areas of application**. These statements are based on our knowledge of typical requirements that are often placed on our products in the areas of application concerned. We nevertheless expressly point out **that such statements cannot be regarded as binding statements about the suitability of our products for a particular customer application**. As a rule, EPCOS is either unfamiliar with individual customer applications or less familiar with them than the customers themselves. For these reasons, it is always ultimately incumbent on the customer to check and decide whether an EPCOS product with the properties described in the product specification is suitable for use in a particular customer application.
2. We also point out that **in individual cases, a malfunction of electronic components or failure before the end of their usual service life cannot be completely ruled out in the current state of the art, even if they are operated as specified**. In customer applications requiring a very high level of operational safety and especially in customer applications in which the malfunction or failure of an electronic component could endanger human life or health (e.g. in accident prevention or lifesaving systems), it must therefore be ensured by means of suitable design of the customer application or other action taken by the customer (e.g. installation of protective circuitry or redundancy) that no injury or damage is sustained by third parties in the event of malfunction or failure of an electronic component.
3. **The warnings, cautions and product-specific notes must be observed.**
4. In order to satisfy certain technical requirements, **some of the products described in this publication may contain substances subject to restrictions in certain jurisdictions (e.g. because they are classed as hazardous)**. Useful information on this will be found in our Material Data Sheets on the Internet (www.epcos.com/material). Should you have any more detailed questions, please contact our sales offices.
5. We constantly strive to improve our products. Consequently, **the products described in this publication may change from time to time**. The same is true of the corresponding product specifications. Please check therefore to what extent product descriptions and specifications contained in this publication are still applicable before or when you place an order. We also **reserve the right to discontinue production and delivery of products**. Consequently, we cannot guarantee that all products named in this publication will always be available. The aforementioned does not apply in the case of individual agreements deviating from the foregoing for customer-specific products.
6. Unless otherwise agreed in individual contracts, **all orders are subject to the current version of the "General Terms of Delivery for Products and Services in the Electrical Industry" published by the German Electrical and Electronics Industry Association (ZVEI)**.
7. The trade names EPCOS, BAOKE, Alu-X, CeraDiode, CSMP, CSSP, CTVS, DSSP, MiniBlue, MKK, MLSC, MotorCap, PCC, PhaseCap, PhaseCube, PhaseMod, SIFERRIT, SIFI, SIKOREL, SilverCap, SIMDAD, SIMID, SineFormer, SIOV, SIP5D, SIP5K, ThermoFuse, WindCap are **trademarks registered or pending** in Europe and in other countries. Further information will be found on the Internet at www.epcos.com/trademarks.