

# RLS-5W-180-S

## SUPER BRIGHT WHITE LED

### ABSOLUTE MAXIMUM RATINGS (Ta = 25°C)

Reverse Voltage	5 V
Reverse Current $V_R = 5 V$	10 $\mu A$
Operating Temperature	-40°C~+85°C
Storage Temperature	-40°C~+100°C
Lead Soldering Temperature	250°C (for 5 seconds)
Power Dissipation	80 mW

### ELECTRICAL AND OPTICAL CHARACTERISTICS (Ta = 25°C)

Emitted Color	Chromaticity Coordinate 20 mA	Lens Appearance	Recommended Values			ELECTRO-OPTICAL (20mA)				Viewing Angle $2\theta_{1/2}$ (deg)
			Pd mW	IF mA	Peak IF(mA)	VF(v)		IV(cd)		
super white	X = 0.28	Water Clear	60	20	150	TYP	max	min	TYP	15±2
	Y = 0.32					3.0	3.4	18	20	

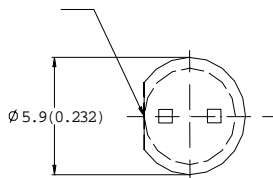
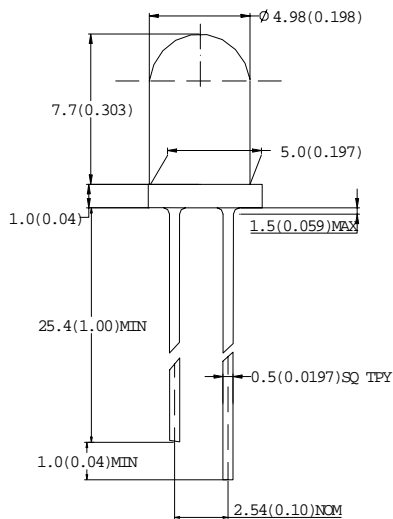

### NOTES:

All dimensions are in millimeters (inches). Tolerance is  $\pm 0.25\text{mm} (0.01)$  unless otherwise specified. The products are sensitive to static electricity and care must be fully taken when handling products. Lead spacing is measured where the leads emerge from the package. Specifications are subject to change without notice

### ROITHNER LASERTECHNIK

Schoenbrunner Straße 7, 1040 Vienna, Austria  
 Tel.: +43-1-586 52 43 – 0, Fax.: +43-1-586 52 43 44  
 office@roithner-laser.com, www.roithner-laser.com