

M-Pulse Microwave

Silicon Bipolar MMIC Cascadable Amplifier

MP4TD0435, MP4TD0436

Features

- Cascadable 50Ω Gain Block
- 3dB Bandwidth: DC to 3.0 GHz
- 9.0 dB Typical Gain @ 1.0 GHz
- Unconditionally Stable ($k > 1$)
- Cost Effective Ceramic Microstrip Package
- Tape and Reel Packaging Available

Description

M-Pulse's MP4TD0435 and MP4TD0436 are high performance silicon bipolar MMICs housed in cost effective ceramic microstrip packages. The MP4TD0435 and MP4TD0436 are designed for use where a general purpose 50Ω gain block is required. Typical applications include narrow and wide band IF and RF amplifiers in industrial and military applications.

The MP4TD0435 and MP4TD0436 are fabricated using a 10 GHz f_T silicon bipolar technology that features gold metalization and IC passivation for increased performance and reliability.

Ceramic Microstrip Case Style Outlines^{1,2,3}

Available in short lead version as MA4TD0436.

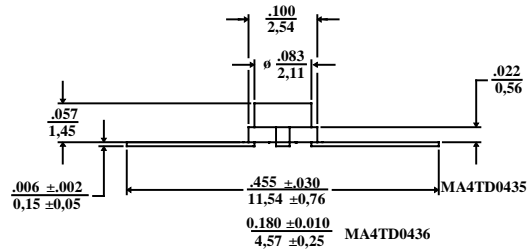
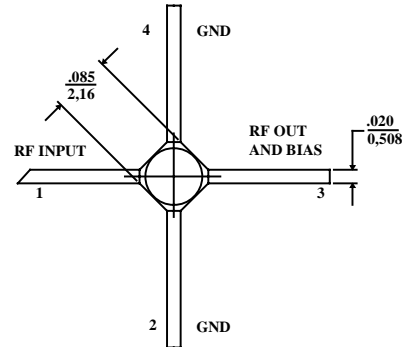

Notes: (unless otherwise specified)

1. Dimensions are in / mm
2. Tolerance: in .xxx = ±.005; mm .xx = ±.13
3. See last page of data sheet for short lead Micro-X

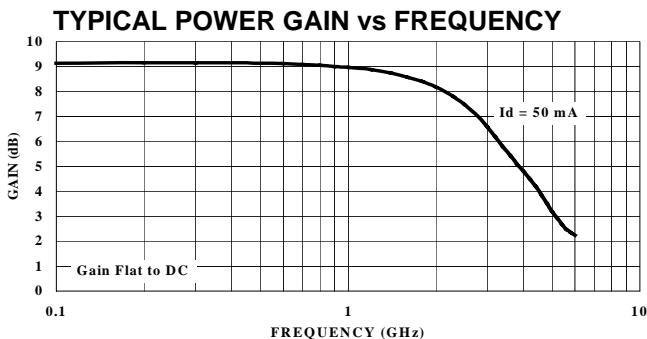

Pin Configuration

Pin Number	Pin Description
1	RF Input
2 & 4	AC/DC Ground
3	RF Output and DC Bias

Electrical Specifications @ $T_A = +25^\circ\text{C}$, $I_d = 50 \text{ mA}$, $Z_0 = 50\Omega$

Symbol	Parameters	Test Conditions	Units	Min.	Typ.	Max.
G_p	Power Gain ($ S_{21} ^2$)	$f = 0.1 \text{ GHz}$	dB	7.5	9.0	9.5
ΔG_p	Gain Flatness	$f = 0.1 \text{ to } 2.0 \text{ GHz}$	dB	-	± 0.5	± 1.0
f_{3dB}	3 dB Bandwidth	-	GHz	-	3.0	-
SWR_{in}	Input SWR	$f = 0.1 \text{ to } 2.0 \text{ GHz}$	-	-	1.5	-
SWR_{out}	Output SWR	$f = 0.1 \text{ to } 2.0 \text{ GHz}$	-	-	1.6	-
P_{1dB}	Output Power @ 1dB Gain Compression	$f = 1.0 \text{ GHz}$	dBm	-	12.5	-
NF	50 Ω Noise Figure	$f = 1.0 \text{ GHz}$	dB	-	6.2	-
IP_3	Third Order Intercept Point	$f = 1.0 \text{ GHz}$	dBm	-	25.5	-
t_D	Group Delay	$f = 1.0 \text{ GHz}$	ps	-	125	-
V_d	Device Voltage	-	V	4.75	5.25	5.75
dV/dT	Device Voltage Temperature Coefficient	-	mV/°C	-	-8.0	-

Specification Subject to Change Without Notice

M-Pulse Microwave

PH (408) 432-1480 FX (408) 432-3440

Absolute Maximum Ratings¹

Parameter	Absolute Maximum
Device Current	100 mA
Power Dissipation ^{2,3}	650 mW
RF Input Power	+13 dBm
Junction Temperature	150°C
Storage Temperature	-65°C to +200°C
Thermal Resistance: $\theta_{jC} = 140 \text{ }^\circ\text{C/W}$	

1. Exceeding these limits may cause permanent damage.
2. Case Temperature (T_c) = 25 °C.
3. Derate at 7.1 mW/°C for $T_c > 109^\circ\text{C}$.

Typical Bias Configuration

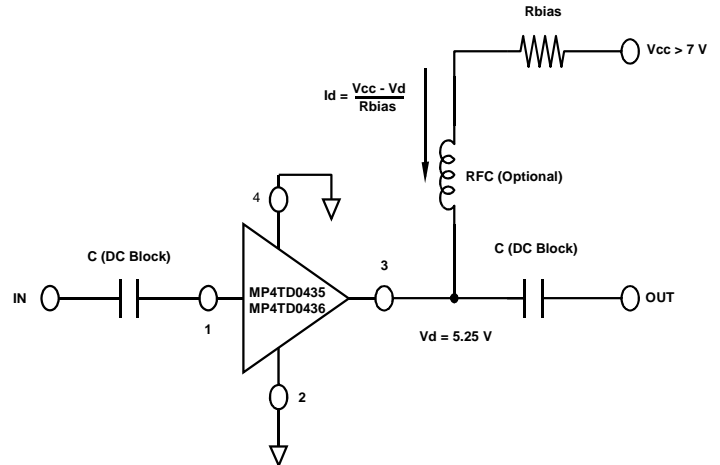

Typical Performance Curves @ $I_d = 50 \text{ mA}$, $T_A = +25^\circ\text{C}$ (unless otherwise noted)

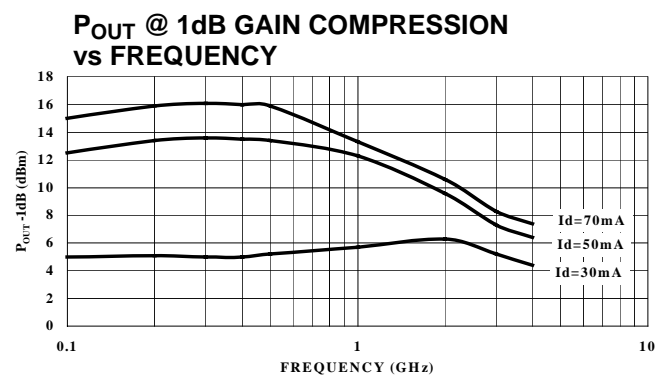
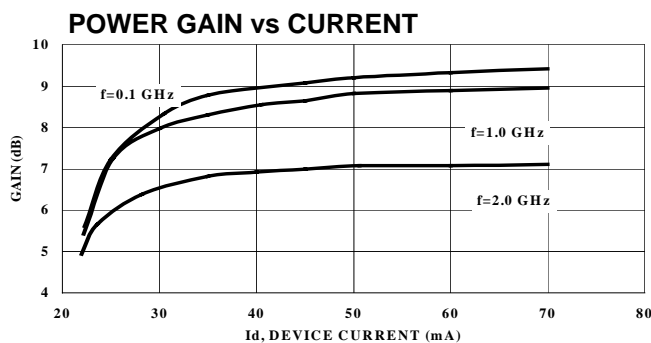
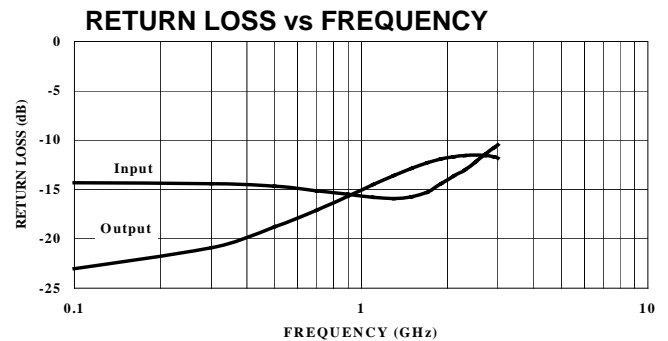
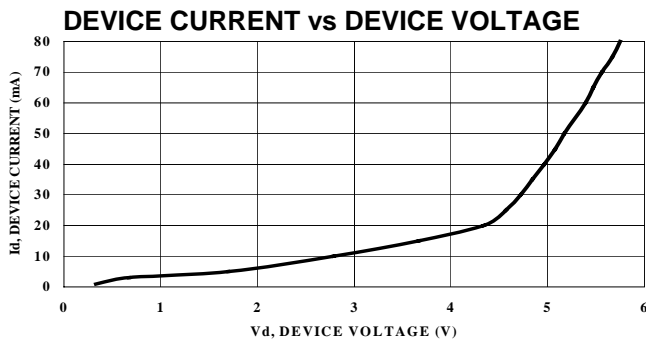

Specification Subject to Change Without Notice

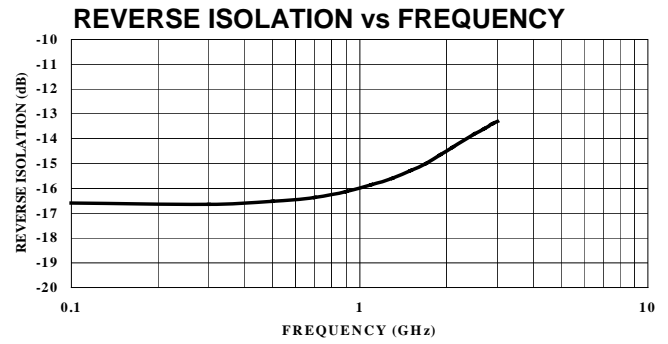
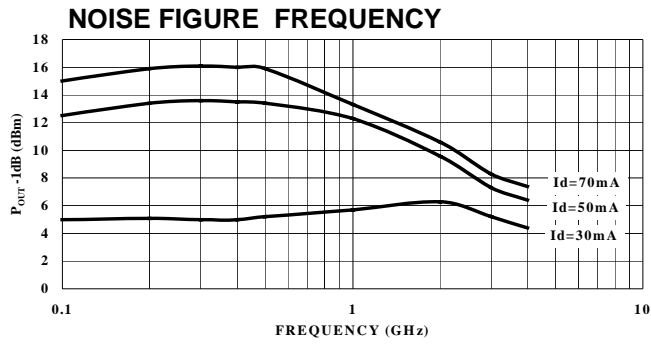

Typical Scattering Parameters

$Z_0 = 50\Omega$, $T_A = +25^\circ\text{C}$, $I_d = 50\text{ mA}$

Frequency (GHz)	S11		S21		S12		S22	
	Mag.	Angle	Mag.	Angle	Mag.	Angle	Mag	Angle
0.1	0.192	169.4	2.86	174.6	0.148	4.9	0.070	3.8
0.2	0.191	170.2	2.86	171.9	0.147	5.4	0.079	-12.4
0.4	0.188	171.7	2.86	164.9	0.147	7.3	0.102	-47.9
0.6	0.180	170.6	2.85	157.3	0.150	10.4	0.128	-73.9
0.8	0.171	169.6	2.83	149.8	0.154	13.8	0.153	-90.2
1.0	0.165	170.1	2.80	142.4	0.158	17.0	0.177	-102.2
1.5	0.163	176.1	2.71	124.2	0.172	24.0	0.228	-126.3
2.0	0.199	-178.6	2.57	106.6	0.188	28.6	0.258	-146.0
2.5	0.245	179.8	2.37	88.7	0.204	31.4	0.266	-161.5
3.0	0.300	173.3	2.14	75.6	0.216	33.8	0.258	-171.2
3.5	0.355	163.9	1.91	64.4	0.228	35.5	0.253	-177.6
4.0	0.407	153.3	1.73	55.0	0.234	37.2	0.251	178.0
4.5	0.456	142.3	1.58	46.2	0.241	40.3	0.262	176.4
5.0	0.508	131.2	1.44	39.1	0.252	42.8	0.279	173.8

Ordering Information

Long Lead Model No.	Short Lead Model No.	Package
MP4TD0435	MP4TD0436	Ceramic
MP4TD0435T	MP4TD0436T	Tape and Reel

Mico-X Case Styles

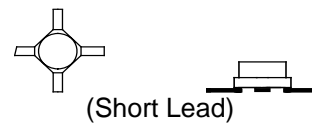
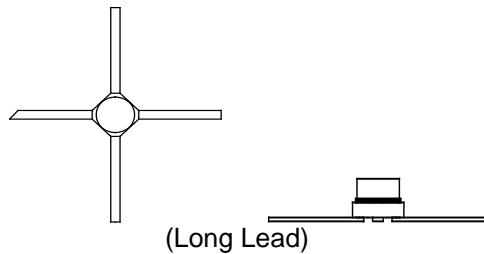

Specification Subject to Change Without Notice