

M-Pulse Microwave

Silicon Bipolar MMIC Cascadable Amplifier

MP4TD4135, MP4TD4136

Features

- Cascadable 50Ω Gain Block
- 3dB Bandwidth: DC to 1.0 GHz
- 15.0 dB Typical Gain @ 0.5 GHz
- Unconditionally Stable ($k > 1$)
- 3.3 Volt Operation
- Cost Effective Ceramic Microstrip Package
- Tape and Reel Packaging Available

Description

M-Pulse's MP4TD4135 and MP4TD4136 are high performance silicon bipolar MMICs housed in a cost effective ceramic microstrip packages. The MP4TD4135 and MP4TD4136 are designed for use where a general purpose 50Ω gain block is required. Typical applications include narrow and wide band IF and RF amplifiers in industrial and military applications.

The MP4TD4135 and MP4TD4136 are fabricated using a 10 GHz f_T silicon bipolar technology that features gold metalization and IC passivation for increased performance and reliability.

Ceramic Microstrip Case Style Outlines^{1,2,3}

Available in short lead version as MP4TD4136.

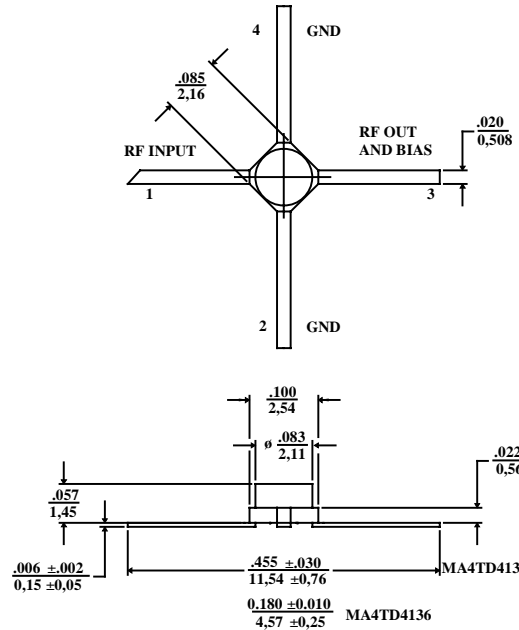

Notes: (unless otherwise specified)

1. Dimensions are in / mm
2. Tolerance: in .xxx = ±.005; mm .xx = ±.13
3. See last page of data sheet for short lead Micro-X

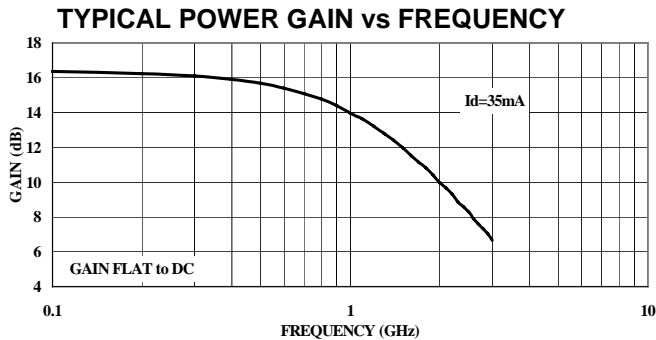

Pin Configuration

Pin Number	Pin Description
1	RF Input
2 & 4	AC/DC Ground
3	RF Output and DC Bias

Electrical Specifications @ $T_A = +25^\circ\text{C}$, $I_d = 35 \text{ mA}$, $Z_0 = 50\Omega$

Symbol	Parameters	Test Conditions	Units	Min.	Typ.	Max.
G_p	Power Gain ($ S_{21} ^2$)	$f = 0.1 \text{ GHz}$	dB	15.5	16.0	17.0
ΔG_p	Gain Flatness	$f = 0.1 \text{ to } 0.9 \text{ GHz}$	dB	-	± 1.0	-
$f_3 \text{ dB}$	3 dB Bandwidth	-	GHz	-	1.2	-
SWR_{in}	Input SWR	$f = 0.1 \text{ to } 1.5 \text{ GHz}$	-	-	1.5	-
SWR_{out}	Output SWR	$f = 0.1 \text{ to } 1.5 \text{ GHz}$	-	-	1.5	-
P_{1dB}	Output Power @ 1dB Gain Compression	$f = 1.0 \text{ GHz}$	dBm	-	8.5	-
NF	50 Ω Noise Figure	$f = 1.0 \text{ GHz}$	dB	-	4.2	-
IP_3	Third Order Intercept Point	$f = 1.0 \text{ GHz}$	dBm	-	19.0	-
t_p	Group Delay	$f = 1.0 \text{ GHz}$	ps	-	200	-
V_d	Device Voltage	-	V	2.8	3.3	3.7
dV/dT	Device Voltage Temperature Coefficient	-	mV/°C	-	-5.0	-

Absolute Maximum Ratings¹

Parameter	Absolute Maximum
-----------	------------------

Specification Subject to Change Without Notice

M-Pulse Microwave

PH (408) 432-1480 FX (408) 432-3440

Device Current	75 mA
Power Dissipation ^{2,3}	200 mW
RF Input Power	+13 dBm
Junction Temperature	200°C
Storage Temperature	-65°C to +200°C
Thermal Resistance: $\theta_{jc} = 150 \text{ }^\circ\text{C/W}$	

1. Exceeding these limits may cause permanent damage.
2. Case Temperature (T_c) = 25 °C.
3. Derate at 6.7 mW/°C for $T_c > 170^\circ\text{C}$.

Typical Bias Configuration

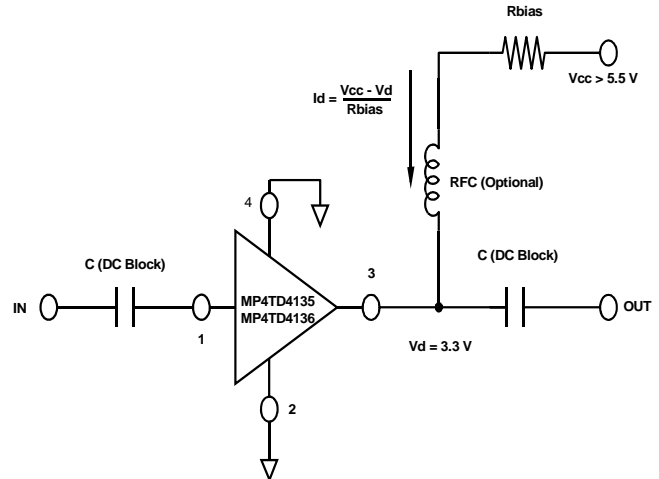

Typical Performance Curves @ $I_d = 35 \text{ mA}$, $T_A = +25^\circ\text{C}$ (unless otherwise noted)

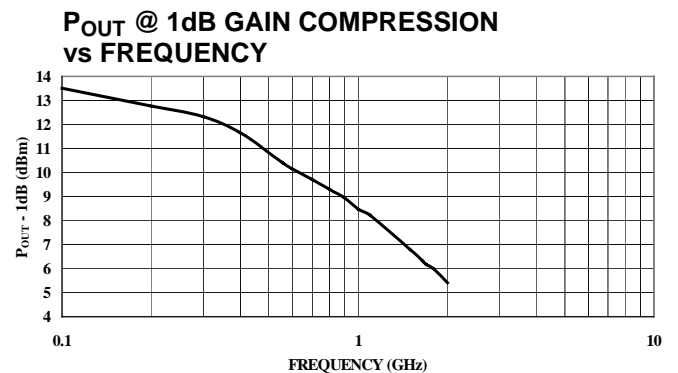
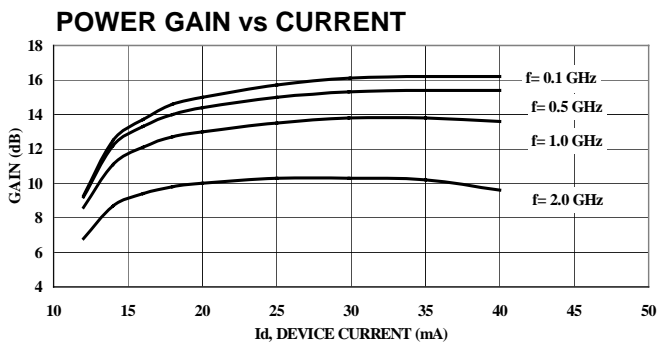
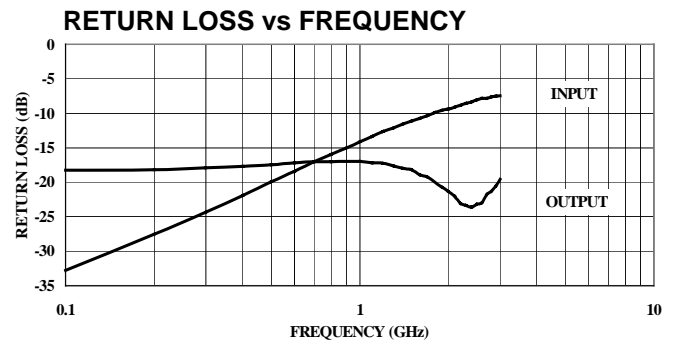
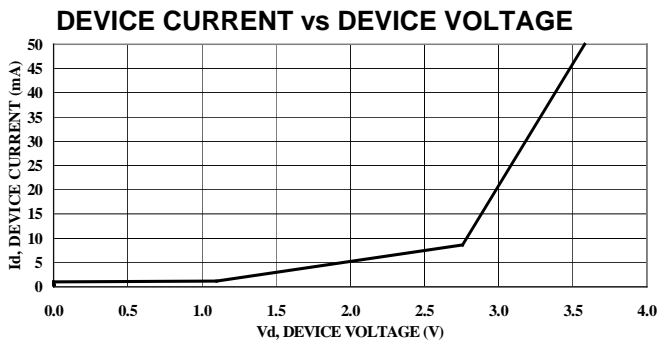

Specification Subject to Change Without Notice

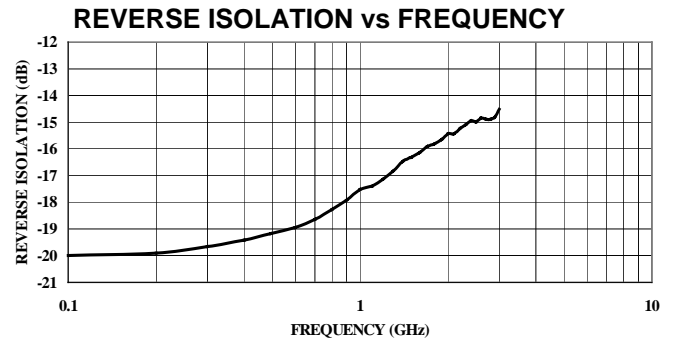
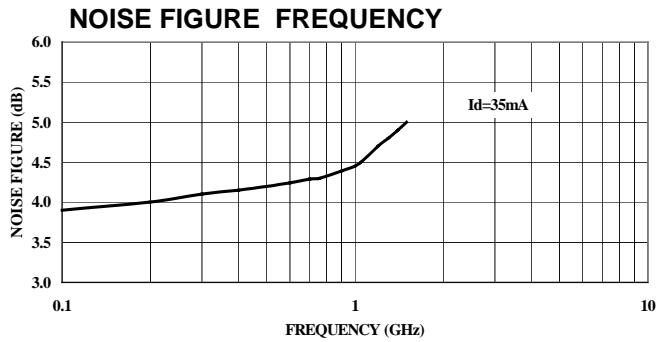

Typical Scattering Parameters
 $Z_0 = 50\Omega$, $T_A = +25^\circ\text{C}$, $I_d = 35 \text{ mA}$

Frequency (GHz)	S11		S21		S12		S22	
	Mag.	Angle	Mag.	Angle	Mag.	Angle	Mag	Angle
0.1	0.023	-59.7	6.58	172.2	0.100	3.3	0.122	-15.0
0.2	0.042	-80.2	6.49	164.7	0.101	6.1	0.123	-30.9
0.3	0.061	-90.0	6.38	157.4	0.104	9.0	0.127	-43.7
0.4	0.080	-98.0	6.24	150.2	0.107	11.3	0.130	-59.2
0.5	0.101	-102.5	6.08	143.4	0.110	13.2	0.134	-72.1
0.6	0.120	-107.1	5.89	136.6	0.113	15.3	0.138	-85.3
0.7	0.141	-111.9	5.68	129.8	0.117	17.2	0.141	-96.9
0.8	0.159	-115.8	5.49	123.5	0.122	18.2	0.141	-107.6
0.9	0.177	-120.8	5.25	117.6	0.127	19.2	0.142	-114.8
1.0	0.196	-124.6	4.99	111.6	0.133	19.8	0.142	-124.8
1.5	0.278	-144.6	3.97	86.7	0.153	19.9	0.123	-152.7
2.0	0.338	-161.6	3.15	66.8	0.169	18.0	0.086	-165.2
2.5	0.394	-175.3	2.60	51.1	0.178	16.3	0.069	-146.3
3.0	0.424	172.6	2.16	38.3	0.188	14.3	0.105	-133.6

Ordering Information

Long Lead Model No.	Short Lead Model No.	Package
MP4TD4135	MP4TD4136	Ceramic Tape and Reel
MP4TD4135T	MP4TD4136T	

Mico-X Case Styles

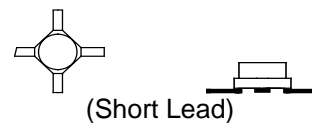
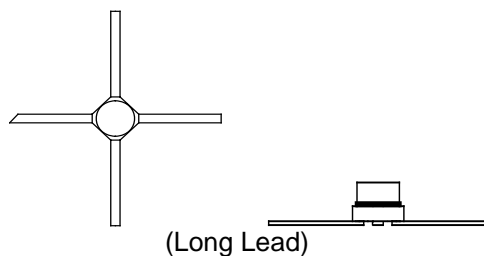

Specification Subject to Change Without Notice