

Factory Programmable Quad PLL Clock Generator with VCXO

Features

- Fully integrated phase-locked loops (PLLs)
- QFN package:
- 40% smaller than 20-pin TSSOP
- 22% smaller than 16-pin TSSOP
- Selectable Output Frequency
- Programmable Output Frequencies
- Output Frequency Range of 5–166 MHz
- Input Frequency Range
- Crystal: 10–30 MHz
- External Reference: 1–100 MHz
- Analog VCXO
- 16-/20-pin TSSOP and 32-pin QFN packages
- 3.3V operation with 2.5V output buffer option

Benefits

- Meets most Digital Set Top Box, DVD Recorder, and DTV application requirements
- Multiple high-performance PLLs allow synthesis of unrelated frequencies
- Integration eliminates the need for external loop filter components
- Meets critical timing requirements in complex system designs
- Enables application compatibility
- Complete VCXO solution with ± 120 ppm (typical pull range)

Block Diagram

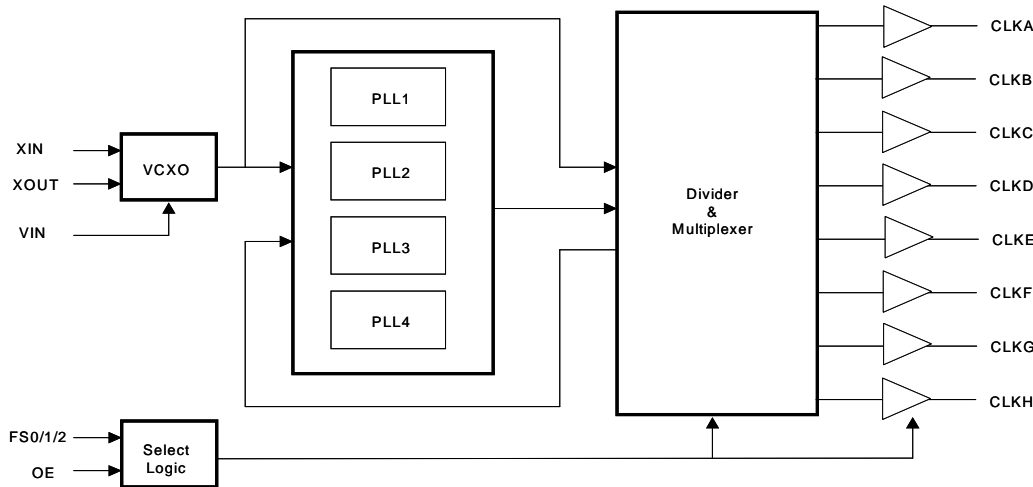

Pin Configurations

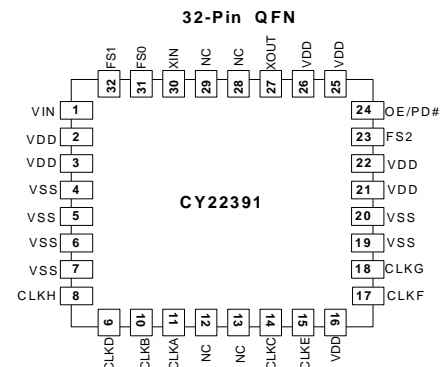
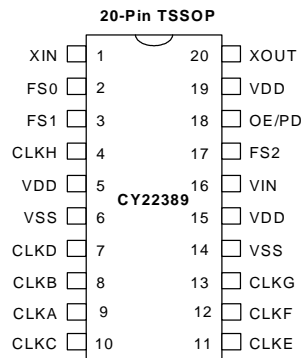
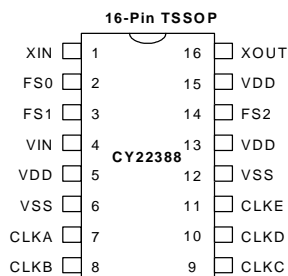

Pin Description

Pin Name	Pin Number			Pin Description
	16-Pin TSSOP	20-Pin TSSOP	32-Pin QFN	
XIN	1	1	30	Crystal Input or Reference Clock Input
XOUT	16	20	27	Crystal Output (No connect if external clock is used)
CLKA	7	9	11	Clock Output
CLKB	8	8	10	Clock Output
CLKC	9	10	14	Clock Output
CLKD	10	7	9	Clock Output
CLKE	11	11	15	Clock Output
CLKF	n/a	12	17	Clock Output
CLKG	n/a	13	18	Clock Output
CLKH	n/a	4	8	Clock Output
FS0	2	2	31	Frequency Select 0
FS1	3	3	32	Frequency Select 1
FS2	14	17	23	Frequency Select 2
OE/PD	n/a	18	24	Output Enable Control/Power Down
VIN	4	16	1	Analog Control Input for VCXO
VDD	5,13,15	5,15,19	2,3,16,21,22,25,26	Voltage Supply
VSS	6,12	6,14	4,5,6,7,19,20	Ground
NC	n/a	n/a	12,13,28,29	No Connect.

General Description

The CY22388 family of devices has an Analog VCXO (Voltage Controlled Crystal Oscillator), 4 PLLs, up to 8 clock outputs and frequency selection capabilities. The frequency selects do not modify any PLL frequency. Instead they allow the user to choose between up to 8 different output divider selections depending on the clock and package configuration. This is illustrated in the following Frequency Selection tables and Functional Block Diagram.

There is one programmable OE/PDWN. The OE/PDWN pin can be programmed as either an output enable pin or a power-down pin. The OE function can be programmed to disable a selected set of outputs when low, leaving the remaining outputs running. Full-chip power down will disable all outputs as well as the PLLs and most of the active circuitry when low.

Factory-Programmable CY22388/89/91

Factory programming is available for high- or low-volume manufacturing by Cypress. All requests must be submitted to the local Cypress Field Application Engineer (FAE) or sales representative. Once the request has been processed, you will receive a new part number, samples, and data sheet with the programmed values. This part number will be used for additional sample requests and production orders.

PLLs

The advantage of having four PLLs is that a single device can generate up to four independent frequencies from a single

crystal. Generally a design may require up to four oscillators to accomplish what could be done with a single CY22388.

Each PLL is independent and can be configured to generate a VCO (Voltage Controlled Oscillator) frequency between 62.5 MHz and 250 MHz. Each PLL can then in turn be divided down with post dividers to generate the clock output frequency of the user's choice. The output divider allows each clock output to be divided by 1,2,3,4,5,6,8,9,10,12,15. The PLL maximum is reduced to 166 MHz in divide by 1 mode due to output buffer limitations.

Outputs that allow frequency switching perform the transition free of glitches. A glitch is defined as a high or low time shorter than half the smaller of the two periods being switched between. Extended low time (even many cycles in duration) is acceptable.

Selected clock outputs are capable of being powered off a separate 2.5V supply. This will allow for driving lower voltage swing inputs. The CY22388/89/91 device still requires 3.3V to power the oscillator and all other internal PLL circuitry. For the 2.5V output option please refer to the CY22388 Application Note. Selected clocks and pinout diagrams will be explained in this application note.

Clock D can obtain its output from either the reference source or PLL1/N1 with N1 being defined as the output divider for PLL1. Clock H is defined as a copy of clock D. Clock D is only available from PLL1/N1 on the 16-pin package.

For CY22388, CLKB and CLKC have related frequencies. For CY22389 and CY22391, CLKD and CLKF have related frequencies, CLKA and CLKB have related frequencies, and

CLKC and CLKE have related frequencies. Related frequencies come from the same PLL but can have different divider values.

In order to minimize PPM (Parts Per Million) error on the clock outputs, a user should choose a crystal reference frequency that is a common multiple of the desired PLL frequencies. While this would be the ideal situation, this is not always the case and the PLLs have high-resolution counters internally to help minimize frequency deviation from the desired frequency.

PLL VCO frequencies are generated by the following equation: $F_{VCO} = F_{REF} * (P / Q)$

Where F_{REF} is the reference input frequency, P is the PLL feedback divider and Q is the reference input divider.

A PLL is a feedback system where the VCO frequency divided by P and reference frequency divided by Q are constantly being compared and the VCO frequency is adjusted to achieve a locked state. Figure 1 is a simplified drawing of a PLL.

Figure 1.

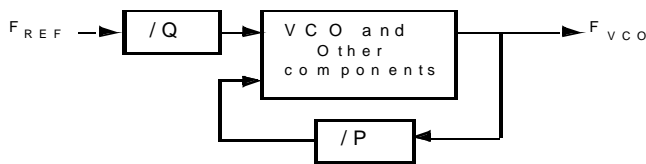

Frequency Select Pin Operation

Table 1. CY22388 16-pin TSSOP

Output Signal	Frequency Selection Lines
CLOCK A	S2S1S0
CLOCK B	S1S0
CLOCK C & CLOCK D	S0
CLOCK E	FIXED

Table 2. CY22389 20-pin TSSOP

Output Signal	Frequency Selection Lines
CLOCK A	S2S1S0
CLOCK B & CLOCK C	S1S0
CLOCK D, CLOCK E, & CLOCK F	S0
CLOCK G	FIXED
CLOCK H	COPY OF CLOCK D

Table 3. CY22391 32-pin QFN

Output Signal	Frequency Selection Lines
CLOCK A	S2S1S0
CLOCK B & CLOCK C	S1S0
CLOCK D, CLOCK E, & CLOCK F	S0
CLOCK G	FIXED
CLOCK H	COPY OF CLOCK D

Analog VCXO

There are three programmable reference operating modes for the CY22388/89/91 family of devices. The first mode utilizes an external pullable crystal and incorporates an internal Analog VCXO.

The second mode configures the internal crystal oscillator to accept an external driven reference source from 1 to 100 MHz. The input capacitance on the XIN PIN when driven in this mode is 15 pF.

The third mode disables the VCXO input control and sets the internal oscillator to a fixed frequency operation. The load capacitance seen by the external crystal when connected to PINS XIN and XOUT is equal to 12 pF.

One of the key components to the CY22388/89/91 family of devices is the analog VCXO. The VCXO is used to “pull” the reference crystal higher or lower in order to lock the system frequency to an external source. This is ideal for applications where the output frequency needs to track along with an external reference frequency that is constantly shifting.

The VCXO is completely analog, so there is infinite resolution on the VCXO pull curve. The Analog to Digital Converter steps that are normally associated with a digital VCXO input is not present in this device. A special pullable crystal must be used in order to have adequate VCXO pull range. Pullable Crystal specifications are included in this data sheet.

Please refer to the CY22388/89/91 Application Note for pullable crystal recommendations outside of the standard industry frequencies given in the Pullable Crystal Specifications.

VCXO Profile

Figure 2 shows an example of what a VCXO profile looks like. The analog voltage input is on the X-axis and the PPM range is on the Y-axis. An increase in the VCXO input voltage results in a corresponding increase in the output frequency. This has the effect of moving the PPM from a negative to positive offset.

Figure 2. VCXO Profile

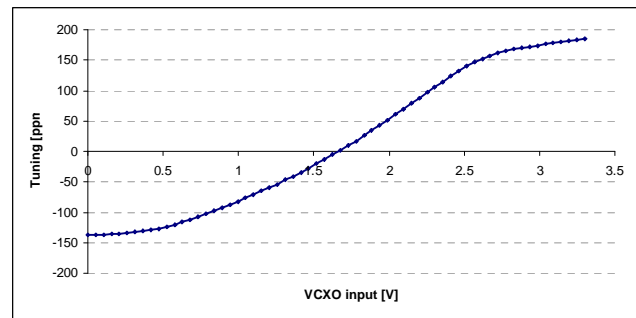

Absolute Maximum Conditions

Parameter	Description	Condition	Min.	Max.	Unit
$V_{DD}/AV_{DD}/V_{DDL}$	Core Supply Voltage		-0.5	4.6	V
V_{IN}	Input Voltage	Relative to V_{SS}	-0.5	$V_{DD} + 0.5$	VDC
T_S	Temperature, Storage	Non-Functional	-65	+125	°C
ESD_{HBM}	ESD Protection (Human Body Model)	MIL-STD-883, Method 3015	2000	-	Volts
UL-94	Flammability Rating	V-0 @ 1/8 in.	-	10	ppm
MSL	Moisture Sensitivity Level	QFN package	3		
		16- and 20-pin TSSOP	1		

Pullable Crystal Specifications^[1, 3]

Parameter	Description	Comments	Min.	Typ.	Max.	Unit
F_{NOM}	13.5-MHz and 27-MHz Crystal AT-Cut	Parallel resonance, Fundamental mode	See Note 3			
C_{LNOM}	Nominal Load Capacitance	Order crystal at one specific C_{LNOM} 0 ppm	11.4	12	12.6	pF
R_1	Equivalent Series Resistance (ESR)	Fundamental mode (CL = Series)	-	-	40	Ω
DL	Crystal Drive Level	Nominal V_{DD} @ 25C over ± 120 PPM Pull Range	-	-	300	μW
$C_0^{[2]}$	Crystal Shunt Capacitance		1.5	3	4.0	pF
$C_1^{[2]}$	Crystal Motional Capacitance		12	14	16.8	fF
$F_{3SEPHI}^{[3]}$	Third Overtone Separation from $3 * F_{NOM}$	Mechanical Third (High side of $3 * F_{NOM}$)	240	-	-	ppm
$F_{3SEPLO}^{[3]}$	Third Overtone Separation from $3 * F_{NOM}$	Mechanical Third (Low side of $3 * F_{NOM}$)	-	-	-120	ppm

Recommended Operating Conditions

Parameter	Description	Min.	Typ.	Max.	Unit
$V_{DD}/AV_{DD}/V_{DDL}$	Operating Voltage	3.0	3.3	3.6	V
T_A	Ambient Temperature	-10	-	70	°C
C_{LOAD}	Maximum Load Capacitance	-	-	15	pF
t_{PU}	Power-up time for all V_{DD} s reach minimum specified voltage (power ramps must be monotonic)	0.05	-	500	ms

Notes

1. Device operates to the following specs, which are guaranteed by design.
2. Increased tolerance available from pull range less than ± 120 PPM.
3. Refer to CY22388 Application Note and online software for a list of Approved Crystal Specifications.

DC Parameters^[4]

Parameter	Description	Conditions	Min.	Typ.	Max.	Unit
$I_{OH}^{[5]}$	Output High Current	$V_{OH} = V_{DD} - 0.5$, $V_{DD} = 3.3V$	12	–	–	mA
$I_{OL}^{[5]}$	Output Low Current	$V_{OL} = 0.5$, $V_{DD} = 3.3V$	12	–	–	mA
I_{IH}	Input High Current	$V_{IH} = V_{DD}$, excluding Vin, Xin	–	5	10	μA
I_{IL}	Input Low Current	$V_{IL} = 0V$, excluding Vin, Xin	–	5	10	μA
V_{IH}	Input High Voltage	FS0/1/2 OE input CMOS levels	$0.7 \times A_{VDD}$	–	–	V
V_{IL}	Input Low Voltage	FS0/1/2 OE input CMOS levels	–	–	$0.3 \times A_{VDD}$	V
V_{VCXO}	VIN Input Range		0	–	A_{VDD}	V
C_{IN}	Input Capacitance	FS0/1/2 and OE Pins only	–	–	7	pF
I_{VDD}	Supply Current	$V_{DD}/A_{VDD}/V_{DDL}$ Current	–	60	–	mA
C_{INXIN}	Input Capacitance at XIN	VCXO Disabled External Reference	–	15	–	pF
C_{INXTAL}	Input Capacitance at Crystal	VCXO Disabled Fixed Freq. Oscillator	–	12	–	pF

AC Parameters

Parameter ^[4]	Description	Conditions	Min.	Typ.	Max.	Units
1/t1	Output Frequency	$PLL_{\min\max}/\text{Divider}_{\max}$	4.2	–	166	MHz
DC1	Output Duty Cycle (excluding REFOUT)	Duty Cycle is defined in Figure 4; t_2/t_1 , 50% of V_{DD} External reference duty cycle between 40% and 60% measured at $V_{DD}/2$ (Clock output is ≤ 125 MHz)	45	50	55	%
DC2	Output Duty Cycle	Duty Cycle is defined in Figure 4; t_2/t_1 , 50% of V_{DD} External reference duty cycle between 40% and 60% measured at $V_{DD}/2$ (Clock output is > 125 MHz)	40	50	60	%
DC _{REFOUT}	Output Duty Cycle	Duty Cycle is defined in Figure 4; t_2/t_1 , 50% of V_{DD} (XIN Duty Cycle = 45/55%)	40	50	60	%
ER	Rising Edge Rate	Output Clock Edge Rate. Measured from 20% to 80% of V_{DD} . $C_{LOAD} = 15$ pF. See Figure 5.	0.75	1.2	–	V/ns
EF	Falling Edge Rate	Output Clock Edge Rate. Measured from 80% to 20% of V_{DD} . $C_{LOAD} = 15$ pF See Figure 5.	0.75	1.2	–	V/ns
T_9	Clock Jitter	Period Jitter	–	± 250	–	ps
T_{10}	PLL Lock Time		–	1	5	ms
$f_{\Delta XO}$	VCXO Crystal Pull Range	Using non-SMD-49 crystal specified in “CY22388 Application Note, ANC0002” Nominal Crystal Frequency Input assumed (0 ppm)@25°C and 3.3V	± 110	± 120	–	ppm
		Using SMD-49 crystal specified in “CY22388 Application Note, ANC0002” Nominal Crystal Frequency Input assumed (0 ppm)@25°C and 3.3V	± 105	± 120	–	ppm

Notes

- Parameters are guaranteed by design and characterization. Not 100% tested in production. All parameters specified with fully loaded outputs.
- Custom Drive level and is available upon request

Test and Measurement Set-up

Figure 3. Test and Measurement

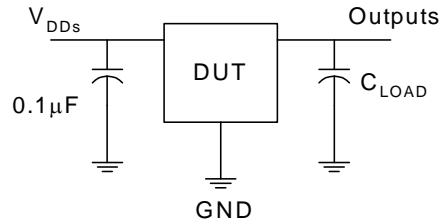

Voltage and Timing Definitions

Figure 4. Duty Cycle Definition

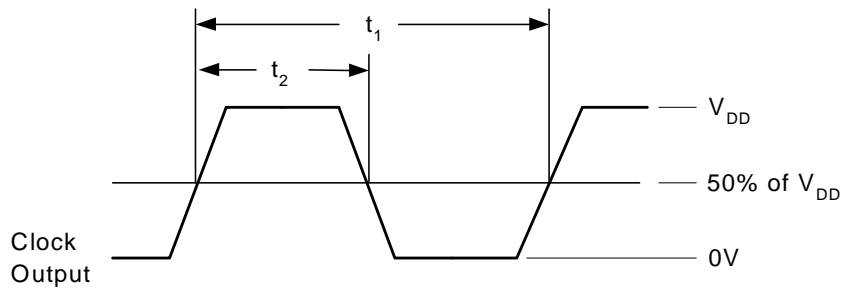

Figure 5. $ER = (0.6 \times V_{DD})/t_3$, $EF = (0.6 \times V_{DD})/t_4$

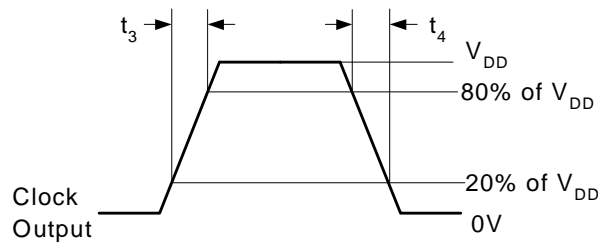
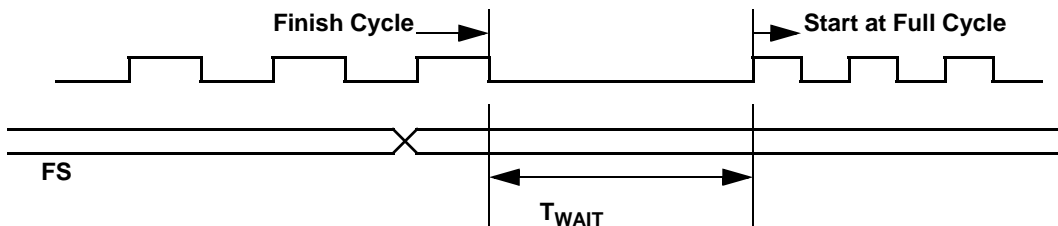

Figure 6. FS Controlled Clock Output



Ordering Information

Part Number ^[6]	Type	Production Flow
Lead-free		
CY22388ZXC-XXX	16-pin TSSOP	Commercial, 0°C to +70°C
CY22389ZXC-XXX	20-pin TSSOP	Commercial, 0°C to +70°C
CY22391LFXC-XXX	32-pin QFN	Commercial, 0°C to +70°C

Package Drawing and Dimensions

Figure 7. 16-lead TSSOP 4.40 mm Body Z16.173

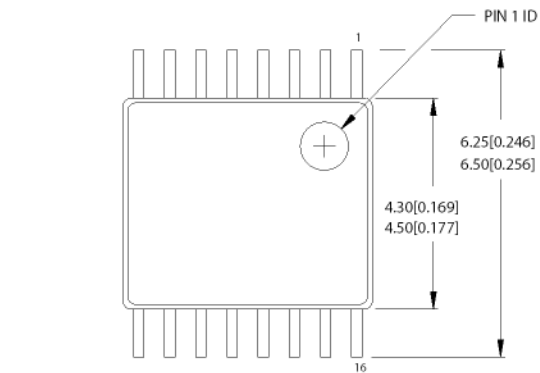

DIMENSIONS IN MM[INCHES] MIN.
MAX.

REFERENCE JEDEC MO-153

PACKAGE WEIGHT 0.05 gms

PART #	
Z16.173	STANDARD PKG.
ZZ16.173	LEAD FREE PKG.

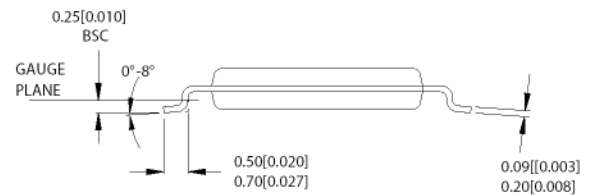
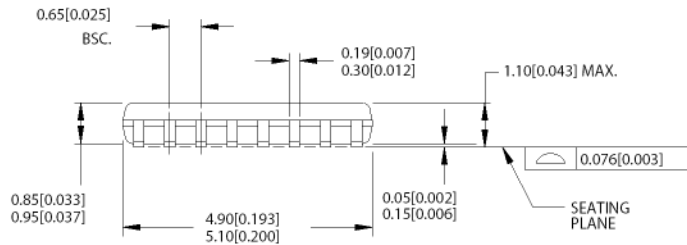

51-85091-A

Note

6. The CY22388ZXC-xxx, CY22389ZXC-xxx, and CY22391LFXC-xxx are factory programmed configurations. For more details, contact your local Cypress FAE or Cypress Sales Representative.

Figure 8. 20-Lead Thin Shrunken Small Outline Package (4.40-mm Body) Z20

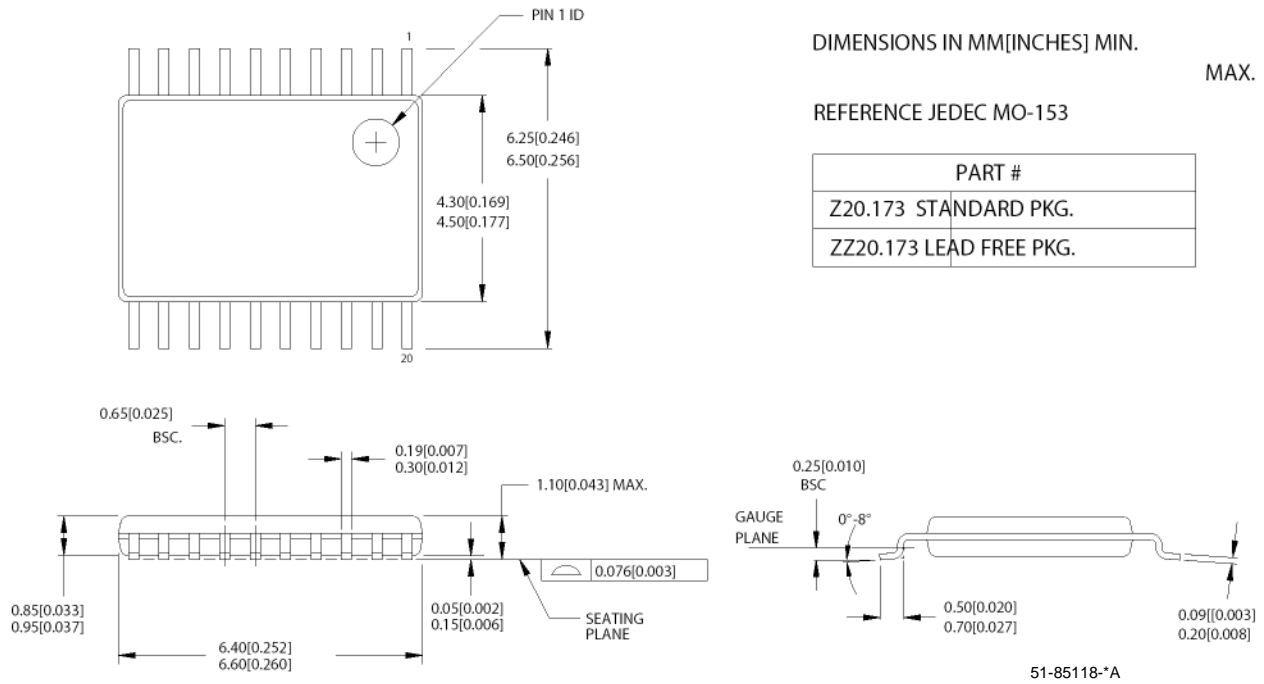
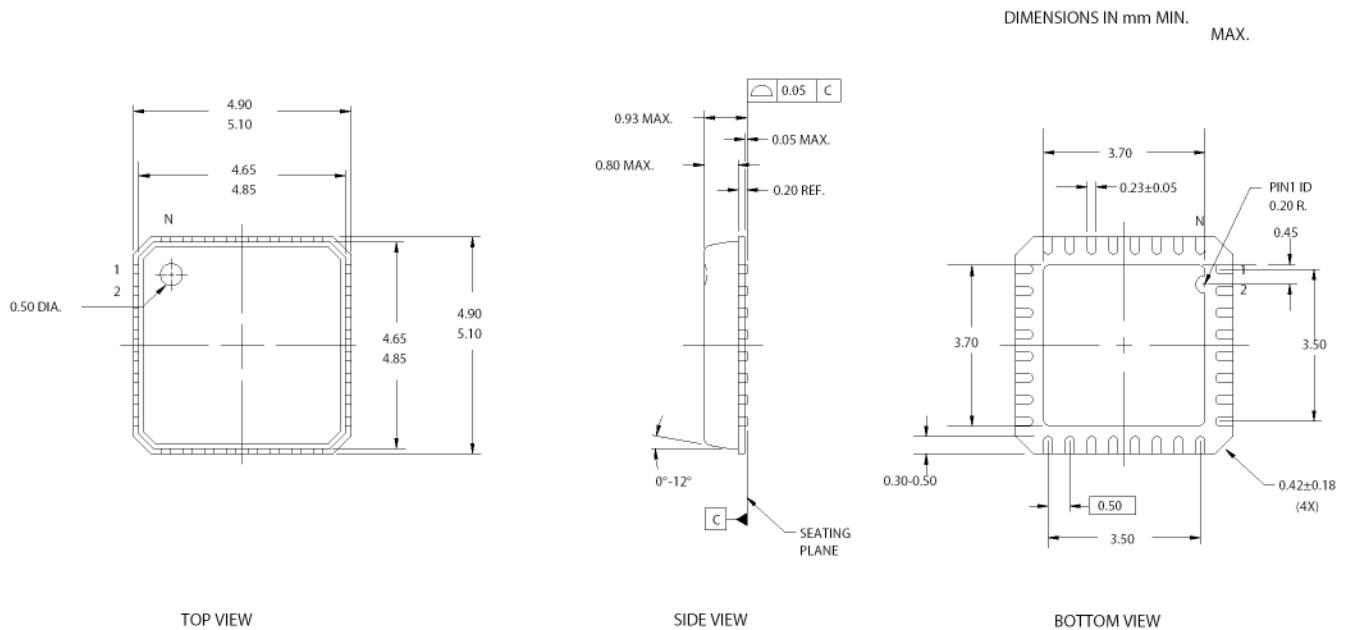

Figure 9. 32-Lead QFN (5 x 5 mm) LF32A



All product and company names mentioned in this document are trademarks of their respective holder.

Document History Page

Document Title: CY22388/89/91 Factory Programmable Quad PLL Clock Generator with VCXO Document Number: 38-07734				
REV.	ECN NO.	Issue Date	Orig. of Change	Description of Change
**	320458	See ECN	RGL	New data sheet
*A	389649	See ECN	RGL	Changed R1 value to max. 40Ω Changed DL comments and max. value to 300μW Changed f _{ΔXO} min. value to ±110ppm and typ. value to ±120ppm
*B	523597	See ECN	RGL	Specified a non-SMD-49 and SMD-49 crystal specs in the VCXO Pull Range Parameter