

1:20 Differential Clock/Data Fanout Buffer

Features

- Twenty ECL/PECL differential outputs
- One ECL/PECL compatible differential or single-ended clock inputs
- One HSTL compatible differential or single-ended clock inputs
- Hot-swappable/-insertable
- 50 ps output-to-output skew
- 150 ps device-to-device skew
- 500 ps propagation delay (typical)
- 1.4 ps RMS period jitter (max.)
- 1.5 GHz Operation (2.7 GHz max. toggle frequency)
- PECL mode supply range: $V_{CC} = 2.5V \pm 5\%$ to $3.3V \pm 5\%$ with $V_{EE} = 0V$
- ECL mode supply range: $V_{EE} = -2.5V \pm 5\%$ to $-3.3V \pm 5\%$ with $V_{CC} = 0V$
- Industrial temperature range: $-40^{\circ}C$ to $85^{\circ}C$
- 52-pin 1.4-mm TQFP package
- Temperature compensation like 100K ECL
- Pin compatible with MC100ES6221

Functional Description

The CY2DP3120 is a low-skew, low propagation delay 1-to-20 differential fanout buffer targeted to meet the requirements of high-performance clock and data distribution applications. The device is implemented on SiGe technology and has a fully differential internal architecture that is optimized to achieve low signal skews at operating frequencies of up to 1.5 GHz.

The device features two differential input paths that are multiplexed internally. This mux is controlled by the CLK_SEL pin. The CY2DP3120 may function not only as a differential clock buffer but also as a signal-level translator and fanout on ECL/PECL signal to twenty ECL/PECL differential loads. An external bias pin, VBB, is provided for this purpose. In such an application, the VBB pin should be connected to either one of the CLKA# or CLKB# inputs and bypassed to ground via a 0.01- μF capacitor. Traditionally, in ECL, it is used to provide the reference level to a receiving single-ended input that might have a different self-bias point.

Since the CY2DP3120 introduces negligible jitter to the timing budget, it is the ideal choice for distributing high frequency, high precision clocks across back-planes and boards in communication systems. Furthermore, advanced circuit design schemes, such as internal temperature compensation, ensure that the CY2DP3120 delivers consistent performance over various platforms.

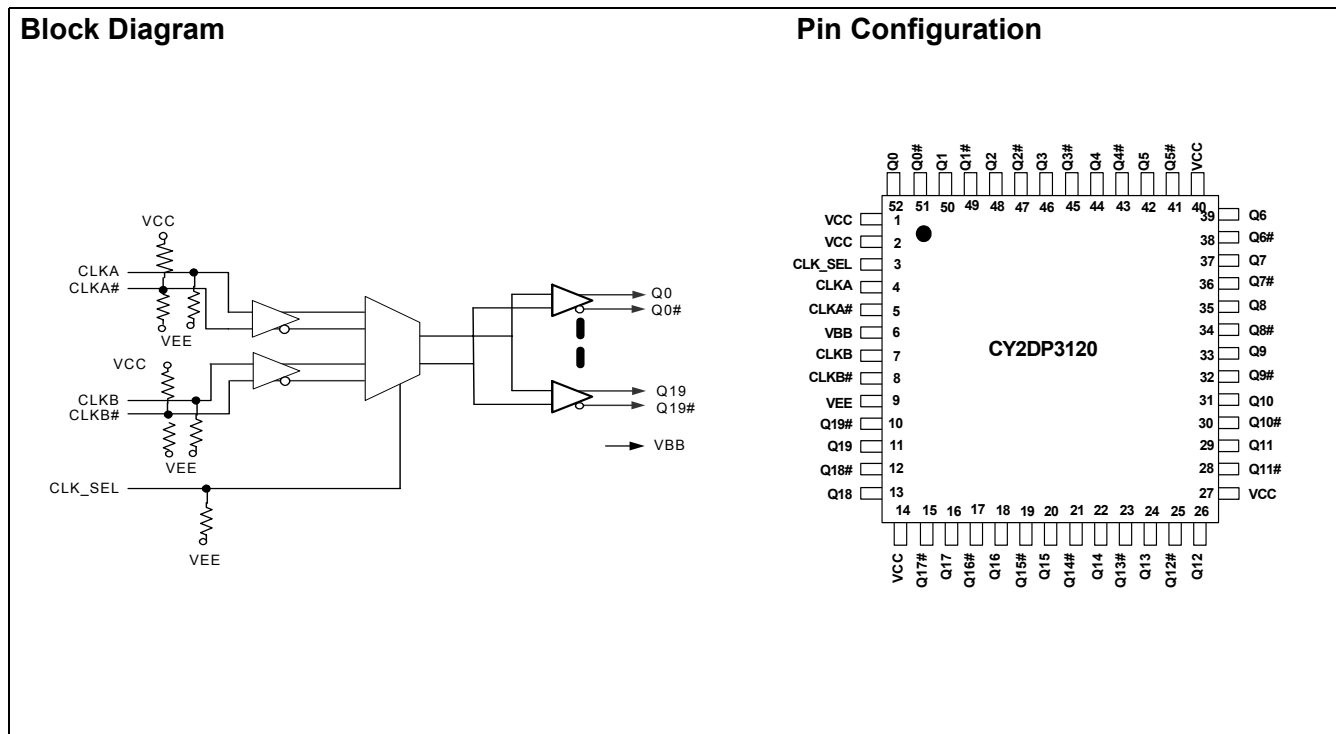

Pin Definitions^[1, 2, 3]

Pin	Name	I/O	Type	Description
3	CLK_SEL	I,PD	ECL/PECL/HSTL	Input clock select
4	CLKA,	I,PD	ECL/PECL	Differential input clocks
6	VBB ^[3]	O	Bias	Reference voltage output
5	CLKA#	I,PD/PU	ECL/PECL	Differential input clocks
7	CLKB,	I,PD	HSTL	Alternate differential input clocks
8	CLKB#	I,PD/PU	HSTL	Alternate differential input clocks
9	VEE ^[2]	-PWR	Power	Negative supply
1,2,14,27,40	VCC	+PWR	Power	Positive Supply
52,50,48,46,44,42,39,37, 35,33,31,29,26,24,22,20, 18,16,13,11	Q(0:19)	O	ECL/PECL	True output
51,49,47,45,43,41,38,36, 34,32,30,28,25,23,21,19, 17,15,12,10	Q#(0:19)	O	ECL/PECL	Complement output

Table 1.

Control	Operation
CLK_SEL	
0	CLKA, CLKA# input pair is active (Default condition with no connection to pin) CLKA can be driven with ECL- or PECL-compatible signals with respective power configurations
1	CLKB, CLKB# input pair is active. CLKB can be driven with HSTL-compatible signals with respective power configurations

Governing Agencies

The following agencies provide specifications that apply to the CY2DP3120. The agency name and relevant specification is listed below in *Table 2*.

Table 2.

Agency Name	Specification
JEDEC	JESD 020B (MSL) JESD 51 (Theta JA) JESD 8-2 (ECL) JESD 65-B (skew,jitter)
Mil-Spec	883E Method 1012.1 (Thermal Theta JC)

Notes:

- In the I/O column, the following notation is used: I for Input, O for Output, PD for Pull-Down, PU for Pull-Up, and PWR for Power
- In ECL mode (negative power supply mode), V_{EE} is either $-3.3V$ or $-2.5V$ and V_{CC} is connected to GND (0V). In PECL mode (positive power supply mode), V_{EE} is connected to GND (0V) and V_{CC} is either $+3.3V$ or $+2.5V$. In both modes, the input and output levels are referenced to the most positive supply (V_{CC}) and are between V_{CC} and V_{EE} .
- V_{BB} is available for use for single-ended bias mode for $|3.3V|$ supplies (not $|2.5V|$).

Absolute Maximum Ratings

Parameter	Description	Condition	Min.	Max.	Unit
V _{CC}	Positive Supply Voltage	Non-Functional	-0.3	4.6	V
V _{EE}	Negative Supply Voltage	Non-Functional	-4.6	0.3	V
T _S	Temperature, Storage	Non-Functional	-65	+150	°C
T _J	Temperature, Junction	Non-Functional		150	°C
ESD _h	ESD Protection	Human Body Model		2000	V
M _{SL}	Moisture Sensitivity Level			3	N.A.
Gate Count	Total Number of Used Gates	Assembled Die		50	gates

Multiple Supplies: The Voltage on any input or I/O pin cannot exceed the power pin during power-up. Power supply sequencing is NOT required.

Operating Conditions

Parameter	Description	Condition	Min.	Max.	Unit
I _{BB}	Output Reference Current	Relative to V _{BB}		200	uA
LU _I	Latch Up Immunity	Functional, typical		100	mA
T _A	Temperature, Operating Ambient	Functional	-40	+85	°C
∅ _{Jc}	Dissipation, Junction to Case	Functional		22 ^[4]	°C/W
∅ _{Ja}	Dissipation, Junction to Ambient	Functional		60 ^[4]	°C/W
I _{EE}	Maximum Quiescent Supply Current	V _{EE} pin		250 ^[5]	mA
C _{IN}	Input pin capacitance			3	pF
L _{IN}	Pin Inductance			1	nH
V _{IN}	Input Voltage	Relative to V _{CC} ^[6]	-0.3	V _{CC} + 0.3	V
V _{TT}	Output Termination Voltage	Relative to V _{CC} ^[6]		V _{CC} - 2	V
V _{OUT}	Output Voltage	Relative to V _{CC} ^[6]	-0.3	V _{CC} + 0.3	V
I _{IN}	Input Current (ECL, PECL and HSTL) ^[7]	V _{IN} = V _{IL} , or V _{IN} = V _{IH}		1150I	uA

PECL/HSTL DC Electrical Specifications

Parameter	Description	Condition	Min.	Max.	Unit
V _{CC}	Operating Voltage	2.5V ± 5%, V _{EE} = 0.0V 3.3V ± 5%, V _{EE} = 0.0V	2.375 3.135	2.625 3.465	V V
V _{CMR}	PECL Input Differential Crosspoint Voltage ^[8]	Differential operation	1.2	V _{CC}	V
V _X	HSTL Input Differential Crosspoint Voltage ^[9]	Standard Load Differential Operation	0.68	0.9	V
V _{OH}	Output High Voltage	I _{OH} = -30 mA ^[10]	V _{CC} - 1.25	V _{CC} - 0.7	V
V _{OL}	Output Low Voltage V _{CC} = 3.3V ± 5% V _{CC} = 2.5V ± 5%	I _{OL} = -5 mA ^[10]	V _{CC} - 1.995 V _{CC} - 1.995	V _{CC} - 1.5 V _{CC} - 1.3	V V
V _{IH}	Input Voltage, High	Single-ended operation	V _{CC} - 1.165	V _{CC} - 0.880 ^[11]	V
V _{IL}	Input Voltage, Low	Single-ended operation	V _{CC} - 1.945 ^[11]	V _{CC} - 1.625	V
V _{BB} ^[3]	Output Reference Voltage	Relative to V _{CC} ^[6]	V _{CC} - 1.620	V _{CC} - 1.220	V

Notes:

- Theta JA EIA JEDEC 51 test board conditions (typical value); Theta JC 883E Method 1012.1
- Power Calculation: V_{CC} * I_{EE} + 0.5 (I_{OH} + I_{OL}) (V_{OH} - V_{OL}) (number of differential outputs used); I_{EE} does not include current going off chip.
- where V_{CC} is 3.3V±5% or 2.5V±5%
- Inputs have internal pull-up/pull-down or biasing resistors which affect the input current.
- Refer to Figure 1
- V_X(AC) is the crosspoint of the differential HSTL input signal. Normal AC operation is obtained when the crosspoint is within the V_X(AC) range and the input swing lies within the V_{DIF}(AC) specification. Violation of V_X(AC) or V_{DIF}(AC) impacts the device propagation delay, device and part-to-part skew. Refer to Fig. 2.
- Equivalent to a termination of 50Ω to V_{TT}. I_{OHMIN}=(V_{OHMIN}-V_{TT})/50; I_{OHMAX}=(V_{OHMAX}-V_{TT})/50; I_{OLMIN}=(V_{OLMIN}-V_{TT})/50; I_{OLMAX}=(V_{OLMAX}-V_{TT})/50;
- V_{IL} will operate down to V_{EE}; V_{IH} will operate up to V_{CC}

ECL DC Electrical Specifications

Parameter	Description	Condition	Min.	Max.	Unit
V _{EE}	Negative Power Supply	-2.5V ± 5%, V _{CC} = 0.0V -3.3V ± 5%, V _{CC} = 0.0V	-2.625 -3.465	-2.375 -3.135	V
V _{CMR}	ECL Input Differential cross point voltage ^[8]	Differential operation	V _{EE} + 1.2	0V	V
V _{OH}	Output High Voltage	I _{OH} = -30 mA ^[10]	-1.25	-0.7	V
V _{OL}	Output Low Voltage V _{EE} = -3.3V ± 5% V _{EE} = -2.5V ± 5%	I _{OL} = -5 mA ^[10]	-1.995 -1.995	-1.5 -1.3	V
V _{IH}	Input Voltage, High	Single-ended operation	-1.165	-0.880 ^[11]	V
V _{IL}	Input Voltage, Low	Single-ended operation	-1.945 ^[11]	-1.625	V
V _{BB} ^[3]	Output Reference Voltage		-1.620	-1.220	V

AC Electrical Specifications

Parameter	Description	Condition	Min.	Max.	Unit
V _{PP}	ECL/PECL Differential Input Voltage ^[8]	Differential operation	0.1	1.3	V
F _{CLK}	Input Frequency	50% duty cycle Standard load		1.5	GHz
T _{PD}	Propagation Delay CLKA or CLKB to Output pair	660 MHz ^[13]	400	750	ps
V _{DIF}	HSTL Differential Input Voltage ^[12]	Duty Cycle Standard Load Differential Operation	0.4	1.9	V
V _o	Output Voltage (peak-to-peak; see Figure 3)	< 1 GHz	0.375	-	V
V _{CMRO}	Output Common Voltage Range (typical)		V _{CC} - 1.425		V
tsk ₍₀₎	Output-to-output Skew	660 MHz ^[13] , See Figure 3	-	50	ps
tsk _(PP)	Part-to-Part Output Skew	660 MHz ^[13]	-	150	ps
T _{PER}	Output Period Jitter (rms) ^[14]	660 MHz ^[13]	-	1.4	ps
tsk _(P)	Output Pulse Skew ^[1]	660 MHz ^[13] , See Figure 3	-	50	ps
T _R , T _F	Output Rise/Fall Time (see Figure 3)	660 MHz 50% duty cycle Differential 20% to 80%	0.08	0.3	ns

Notes:

12. V_{DIF} (AC) is the minimum differential HSTL input voltage swing required to maintain AC characteristics including tkpd and device-to-device skew

13. 50% duty cycle; standard load; differential operation

14. For 3.3V supplies. Jitter measured differentially using an Agilent 8133A Pulse Generator with an 8500A LeCroy Wavemaster Oscilloscope using at least 10,000 data points

Output pulse skew is the absolute difference of the propagation delay times: |t_{PLH} - t_{PHL}|.

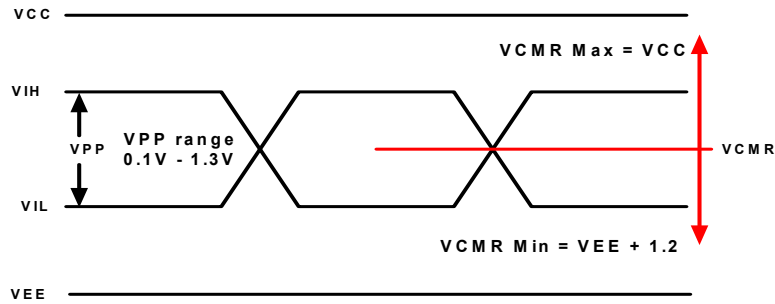
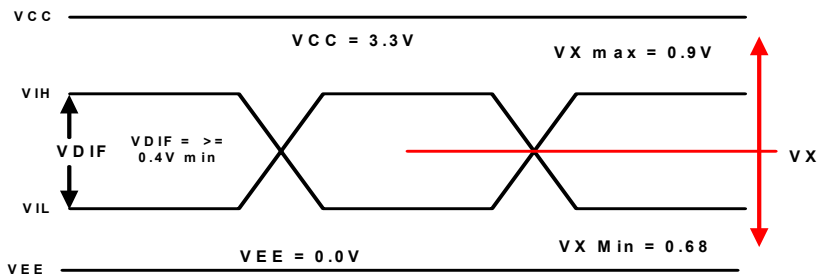
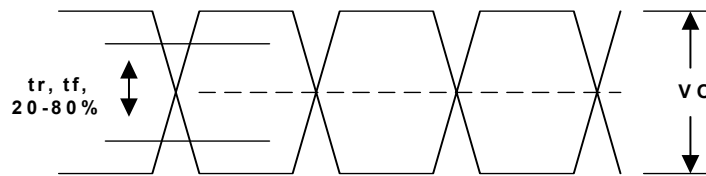
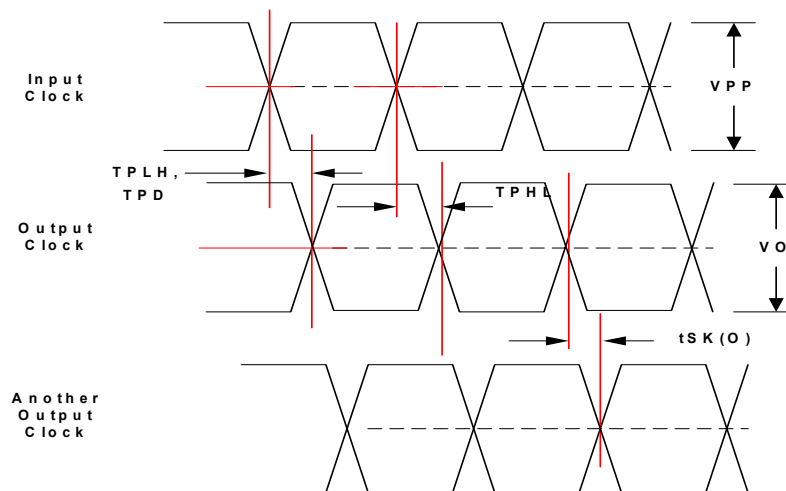
Timing Definitions

Figure 1. PECL/ECL Input Waveform Definitions

Figure 2. HSTL Differential Input Waveform Definitions

Figure 3. ECL/LVPECL Output

Figure 4. Propagation Delay (T_{PD}), output pulse skew ($|t_{PLH} - t_{PHL}|$), and output-to-output skew ($t_{SK(O)}$) for both CLKA or CLKB to Output Pair, PECL/ECL to PECL/ECL

Test Configuration

Standard test load using a differential pulse generator and differential measurement instrument.

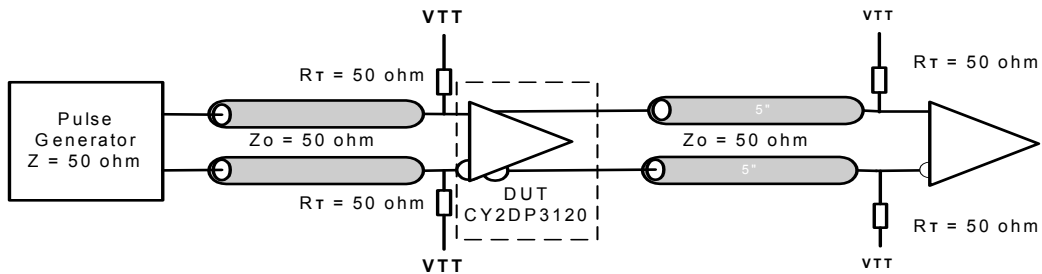

Figure 5. CY2DP3120 AC Test Reference

Applications Information

Termination Examples

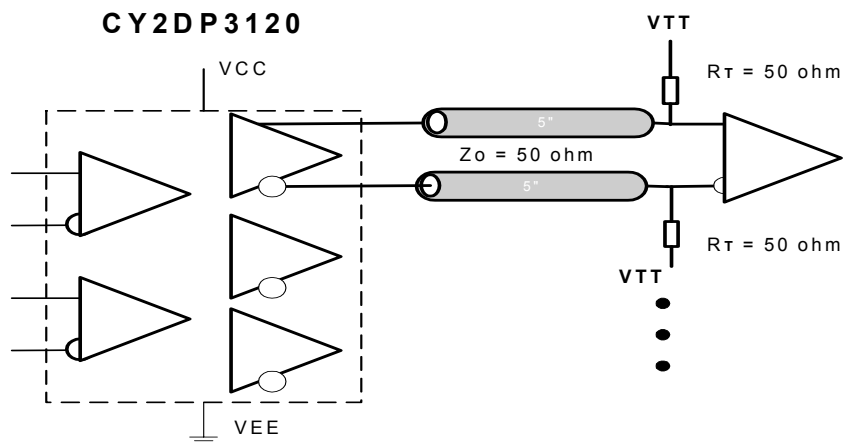

Figure 6. Standard LVPECL – PECL Output Termination

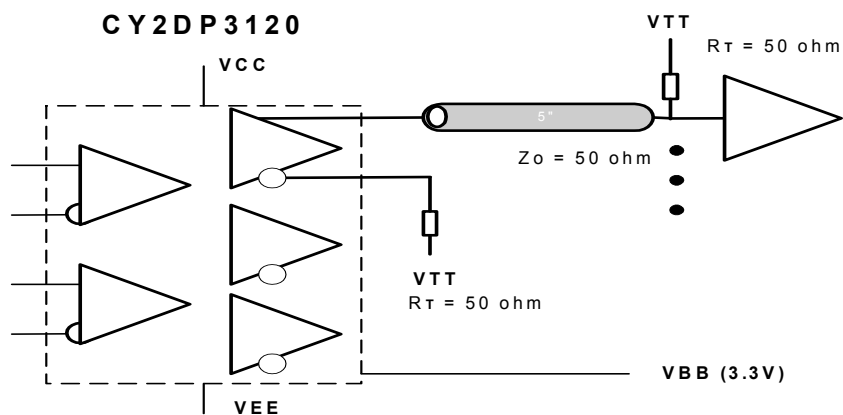

Figure 7. Driving a PECL/ECL Single-ended Input

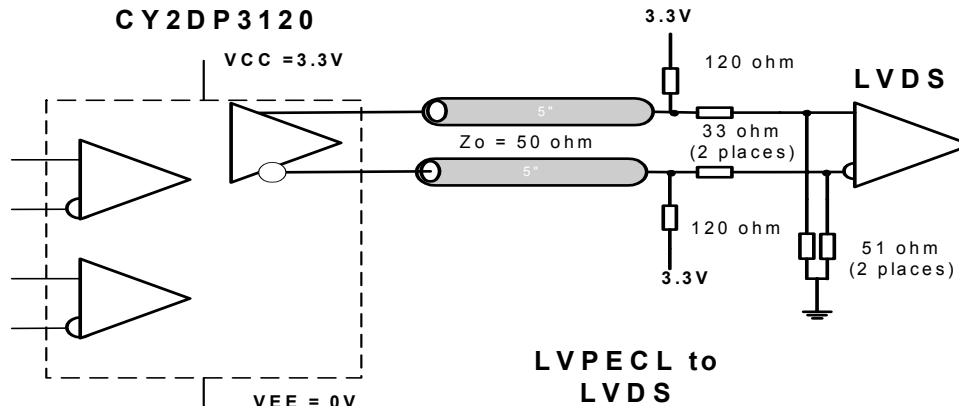
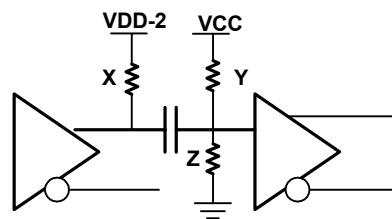

Figure 8. Low-voltage Positive Emitter-coupled Logic (LVPECL) to a Low-voltage Differential Signaling (LVDS) Interface



One output is shown for clarity

Figure 9. Termination for LVPECL to HTSL interface for VCC=2.5V would use X=50 Ohms, Y=2300 Ohms, and Z=1000 Ohms. See application note titled, "PECL Translation, SAW Oscillators, and Specs" for other signalling standards and supplies.

Ordering Information

Part Number	Package Type	Product Flow
CY2DP3120AI	52-pin TQFP	Industrial, -40° to 85°C
CY2DP3120AIT	52-pin TQFP – Tape and Reel	Industrial, -40° to 85°C
CY2DP3120AXI	52-pin TQFP - Lead Free	Industrial, -40° to 85°C
CY2DP3120AXIT	52-pin TQFP – Tape and Reel - Lead Free	Industrial, -40° to 85°C

Package Diagram

52-lead Thin Plastic Quad Flat Pack (10 × 10 × 1.4 mm) A52

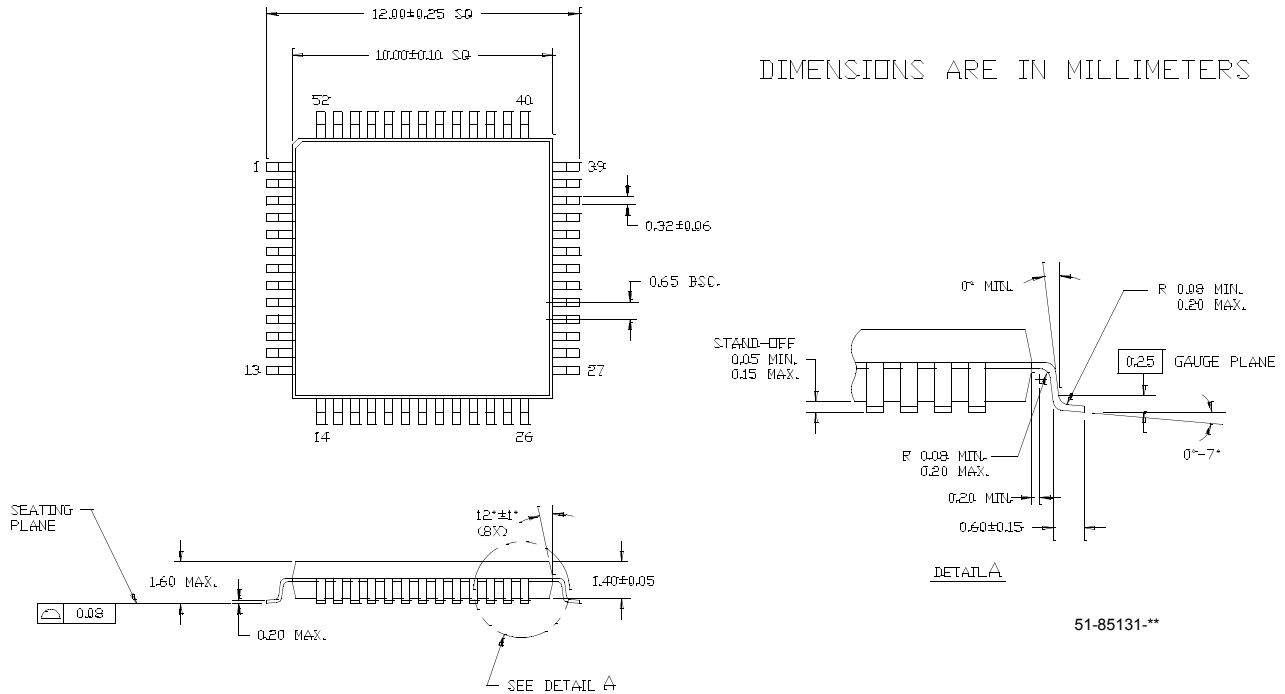

FastEdge is a trademark of Cypress Semiconductor Corporation. All product and company names mentioned in this document are the trademarks of their respective holders.

Document History Page

Document Title: CY2DP3120 FastEdge™ Series 1:20 Differential Clock/Data Fanout Buffer				
Document Number: 38-07514				
REV.	ECN NO.	Issue Date	Orig. of Change	Description of Change
**	122438	12/05/02	RGL	New data sheet
*A	125457	04/17/03	RGL	Corrected typo Q14 to Q4 in pin 44 in the pin configuration diagram Changed pin #s 1,14,27 and 40 from VCC to VCCO Changed title to FastEdge™ Series 1:20 Differential Clock/Data Fanout Buffer
*B	229391	See ECN	RGL	Supplied data to all TBD's to match the device
*C	247606	See ECN	RGL/GGK	Changed V_{OH} and V_{OL} to match the Char Data