

## FEATURES

- FLUIDIZED BED PROCESS
- NEW REDUCED SIZES
- FLAME RETARDANT COATING
- LOW LEAKAGE CURRENT AND IMPEDANCE
- EXCEPTIONAL TEMPERATURE STABILITY

## RoHS Compliant

includes all homogeneous materials

\*See Part Number System for Details



## SPECIFICATIONS

Capacitance Range:	0.1 $\mu$ F ~ 330 $\mu$ F						
Capacitance Tolerance:	$\pm$ 20% (M), $\pm$ 10% (K)						
Rated Voltage (VDC):	6.3	10	16	20	25	35	50
Surge Voltage (VDC):	8	13	20	26	36	46	65
Temperature Range:	-55°C ~ +85°C (+125°C with Derating)						
Dissipation Factor: (120hz, +25°C) Tan $\delta$	Capacitance Range			Tan $\delta$			
	0.1 ~ 1.5 $\mu$ F			Less than 4%			
	2.2 ~ 6.8 $\mu$ F			Less than 6%			
	10 ~ 68 $\mu$ F			Less than 8%			
Reliability:	1% per 1000 hrs. at 85°C with 0.1 $\Omega$ /V series impedance, 60% confidence level						

## DERATED VOLTAGE AND SURGE VOLTAGE

Rated Voltage (VDC)	+85°C:	6.3	10	16	20	25	35	50
Derated Voltage (VDC)	+125°C:	4	6.3	10	13	16	23	33
Surge Voltage (VDC)	+85°C:	8	13	20	26	33	46	65
Derated Surge Voltage (VDC)	+125°C:	5	9	12	16	21	28	40

Maximum Leakage Current ( $\mu$ A) @ 25°C After 3 minutes							
Cap ( $\mu$ F)	Rated Voltage (VDC)						
	6.3V	10V	16V	20V	25V	35V	50V
0.1	-	-	-	-	-	0.5	0.5
0.15	-	-	-	-	-	0.5	0.5
0.22	-	-	-	-	-	0.5	0.5
0.33	-	-	-	-	-	0.5	0.5
0.47	-	-	-	-	-	0.5	0.5
0.68	-	-	-	-	-	0.5	0.5
1.0	-	-	-	0.5	0.5	0.5	0.5
1.5	-	-	0.5	0.5	0.5	0.5	0.6
2.2	-	0.5	0.5	0.5	0.5	0.6	0.8
3.3	0.5	0.5	0.5	0.5	0.6	0.9	1.3
4.7	0.5	0.5	0.6	0.7	0.9	1.3	1.8
6.8	0.5	0.5	0.8	1.0	1.3	1.9	2.7
10	0.5	0.8	1.2	1.6	2.0	2.8	4.0
15	0.8	1.2	1.9	2.4	3.0	4.2	6.0
22	1.1	1.7	2.8	3.5	4.4	6.1	8.8
33	1.7	2.6	4.2	5.2	6.6	9.2	-
47	2.4	3.7	6.0	7.5	9.4	10.0	-
68	3.4	5.4	8.7	10.8	13.6	-	-
100	5.0	8.0	12.8	16.0	-	-	-
150	7.6	12.0	19.2	-	-	-	-
220	11.0	17.6	20.0	-	-	-	-
330	16.6	20.0	-	-	-	-	-

Max. ESR (ohm) @ 100Khz and 25°C							
Cap ( $\mu$ F)	Rated Voltage (VDC)						
	6.3V	10V	16V	20V	25V	35V	50V
0.1	-	-	-	-	-	26.0	26.0
0.15	-	-	-	-	-	21.0	21.0
0.22	-	-	-	-	-	17.0	17.0
0.33	-	-	-	-	-	15.0	15.0
0.47	-	-	-	-	-	13.0	13.0
0.68	-	-	-	-	-	10.0	10.0
1.0	-	-	-	10.0	10.0	8.0	8.0
1.5	-	-	10.0	9.0	8.0	6.0	6.0
2.2	-	13.0	8.0	7.0	6.0	5.0	3.5
3.3	13.0	10.0	6.0	5.5	5.0	4.0	3.0
4.7	10.0	8.0	5.0	4.5	4.0	3.0	2.5
6.8	8.0	6.0	4.0	3.6	3.1	2.5	2.0
10	6.0	5.0	3.2	2.9	2.5	2.0	1.6
15	5.0	3.7	2.5	2.3	2.0	1.6	1.2
22	3.7	2.7	2.0	1.8	1.5	1.3	1.0
33	3.0	2.1	1.6	1.4	1.2	1.0	-
47	2.0	1.7	1.3	1.2	1.0	0.8	-
68	1.8	1.3	1.0	0.9	0.8	-	-
100	1.6	1.0	0.8	0.6	-	-	-
150	0.9	0.8	0.6	-	-	-	-
220	0.9	0.6	0.5	-	-	-	-
330	0.7	0.5	-	-	-	-	-

## PRECAUTIONS

Please review the notes on correct use, safety and precautions found on pages T10 & T11 of NIC's Electrolytic Capacitor catalog.

Also found at [www.nicomp.com/precautions](http://www.nicomp.com/precautions)

If in doubt or uncertainty, please review your specific application - process details with NIC's technical support personnel: [tpmg@nicomp.com](mailto:tpmg@nicomp.com)

## DIMENSIONS (mm)

Diameter	Figure And Part No.	Lead Spacings	Lead Length	Lead Diameter (d)
4.5 ~ 8.0	1 Standard	2.5±0.5	16±4	0.5±0.05
4.5 ~ 8.0	2 Optional (F2) Style	5.0±1.0	16±4	0.5±0.05
8.5 ~ 10.0	2 Standard	5.0±1.0	16±4	0.5±0.05

## OUTLINE DRAWINGS AND DIMENSIONS

MARKING: (Note:  $\mu$  represents decimal point for values below 1 $\mu$ F)

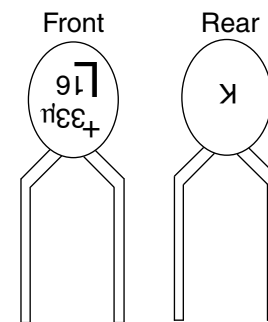

## STANDARD PRODUCTS AND CASE SIZE TABLE D $\phi$ X H (mm)

Cap ( $\mu$ F)	Code	Rated Voltage (Vdc)						
		6.3	10	16	20	25	35	50
0.1	104	-	-	-	-	-	4.5x7.0	4.5x7.0
0.15	154	-	-	-	-	-	4.5x7.0	4.5x7.0
0.22	224	-	-	-	-	-	4.5x7.0	4.5x7.0
0.33	334	-	-	-	-	-	4.5x7.0	4.5x7.0
0.47	474	-	-	-	-	-	4.5x7.0	4.5x7.0
0.68	684	-	-	-	-	-	4.5x7.0	4.5x7.5
1.0	105	-	-	-	4.5x7.0	4.7x7.0	4.5x7.0	5.0x8.5
1.5	155	-	-	4.5x7.0	4.5x7.0	4.5x7.0	4.5x7.0	5.0x9.0
2.2	225	-	4.5x7.0	4.5x7.0	4.5x7.0	4.5x7.0	4.5x7.5	5.5x9.0
3.3	335	4.5x7.0	4.5x7.0	4.5x7.0	4.5x7.5	4.5x7.5	5.0x8.5	6.0x10.0
4.7	475	4.5x7.0	4.5x7.0	4.5x7.5	5.0x8.5	5.0x8.5	5.5x9.0	6.5x10.0
6.8	685	4.5x7.0	4.5x7.5	5.0x8.5	5.0x9.0	5.0x9.0	6.0x10.0	7.0x10.5
10	106	4.5x7.5	5.0x8.5	5.0x9.0	5.5x9.0	5.5x9.0	6.0x10.0	8.0x13.0
15	156	5.0x8.5	5.0x9.0	5.5x9.0	6.0x10.0	6.0x10.0	7.0x10.5	8.5x14.0
22	226	5.0x9.0	5.5x9.0	6.0x10.0	7.0x10.5	7.0x10.5	8.5x14.0	9.0x14.0
33	336	5.5x9.0	6.0x10.0	6.0x10.0	8.0x13.0	8.0x13.0	9.0x14.5	-
47	476	6.0x10.0	6.5x10.0	8.0x13.0	8.5x14.0	9.0x14.5	9.0x16.0	-
68	686	6.5x10.0	7.0x10.5	9.0x14.0	9.0x16.0	9.0x16.0	-	-
100	107	7.0x10.5	8.5x14.0	9.0x16.0	9.0x16.0	-	-	-
150	157	8.5x14.0	9.0x16.0	9.0x16.0	-	-	-	-
220	227	9.0x14.5	10.0x17.0	10.0x18.5	-	-	-	-
330	337	10.0x17.0	10.0x18.5	-	-	-	-	-

FIG. 1

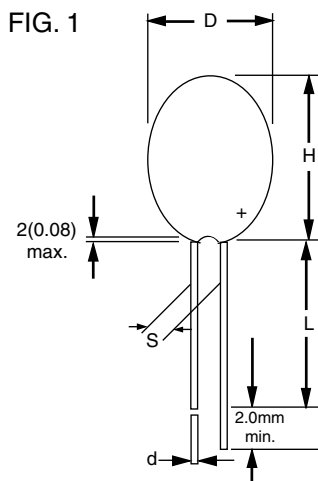
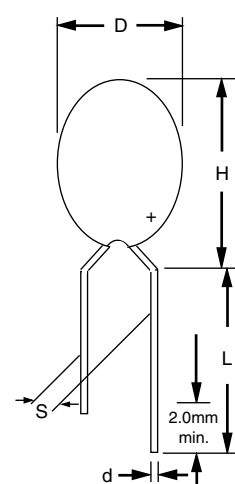
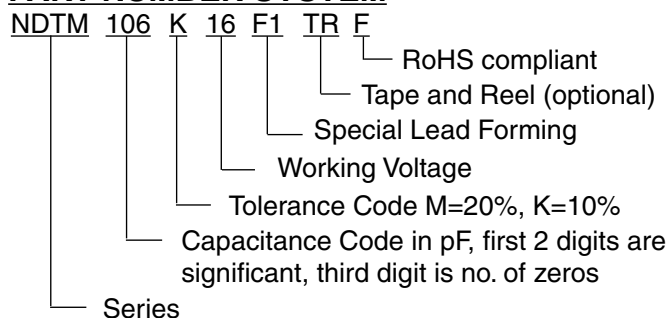

FIG. 2



## PART NUMBER SYSTEM



## TAPING DIMENSIONS (mm)

Code	Dimensions
P	12.7±0.3
P1	5.50±1.0
P2	6.35±0.4
°P	±1.0
d	0.5±0.05
S	F2TR,F2TB=5.0 F1TR,F1TB=2.5
Δh	±2.0
D	4.0±0.2
W	± 1.0 18 - 0.5
W1	6.0 min.
W2	1.0 max.
H	16±0.5 19±1.0
H1	9.0±0.5
H2	18.0
H3	32.25
L	11.0 max.
T	0.7±0.2

Parts with diameters up to 9.0mm are available packaged on tape. Larger diameter parts are bulk only.

## PACKAGING QUANTITIES

Case Size	Reel	Ammo
4.5x7.0	1000-1500	3000
4.5x7.5	1000-1250	3000
5.0x8.5	1000-1250	3000
5.0x9.0	1000-1250	3000
5.5x9.0	1000	2500
6.0x10.0	1000	2500
6.5x10.0	750	2500
7.0x10.5	750	2000
8.0x13.0	750	-----
8.5x14.0	500	-----
9.0x14.0	500	-----
9.0x14.5	500	-----

### F2TR, F2TB (UNDER 8.0mm DIAMETER) 5.0mm lead spacing.

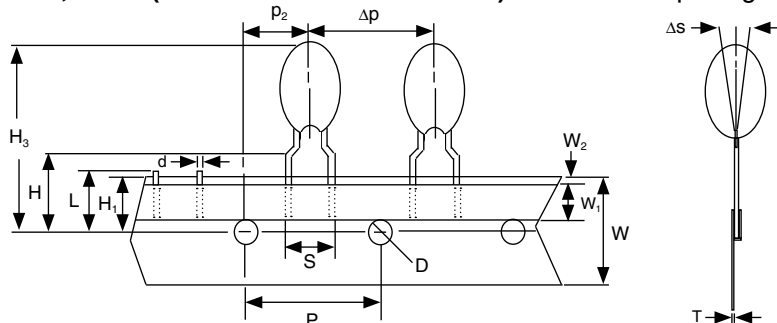

### F2TR, F2TB (8.0mm AND OVER) 5.0mm lead spacing.

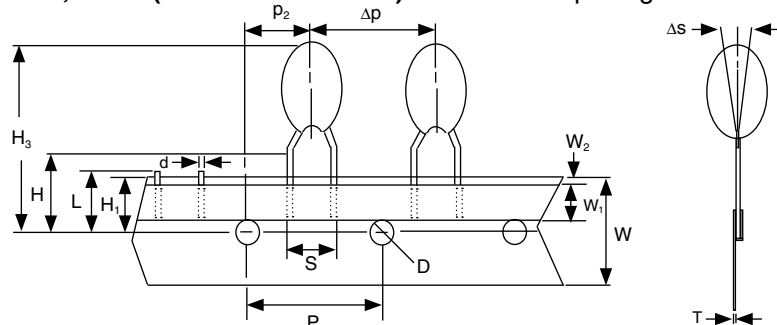

### F1TR, F1TB 2.5mm lead spacing.

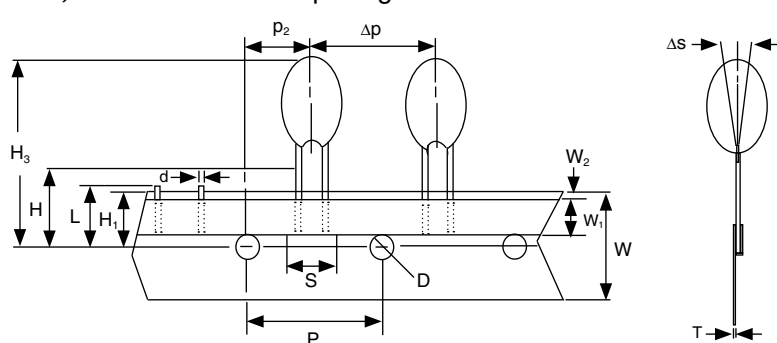

## REEL DIMENSIONS (mm)

