

Technical Data Sheet

5mm Infrared LED, T-1 3/4

SIR333C

Features

- High reliability
- 2.54mm lead spacing
- Low forward voltage
- Good spectral matching to Si photodetector
- Pb free
- The product itself will remain within RoHS compliant version.

Descriptions

EVERLIGHT's infrared emitting diode (SIR333C) is a high intensity diode, molded in a water clear plastic package.

The device is spectrally matched with phototransistor, photodiode and infrared receiver module.

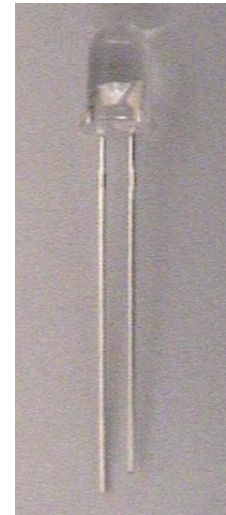

Applications

- Free air transmission system
- Optoelectronic switch
- Floppy disk drive
- Infrared applied system
- Smoke detector

Device Selection Guide

LED Part No.	Chip	Lens Color
	Material	
SIR	GaAlAs	Water clear

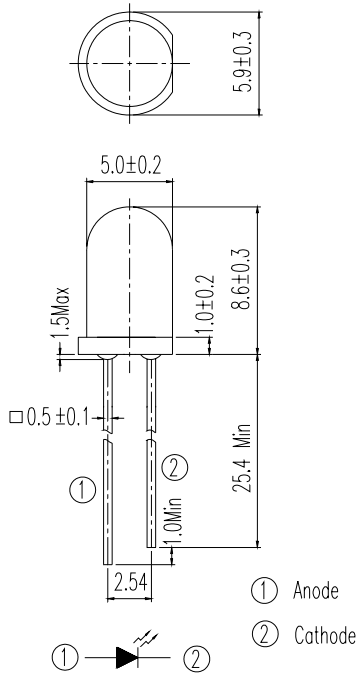
Package Dimensions

- Notes:** 1.All dimensions are in millimeters
2.Tolerances unless dimensions $\pm 0.25\text{mm}$

Absolute Maximum Ratings ($T_a=25^\circ\text{C}$)

Parameter	Symbol	Rating	Units
Continuous Forward Current	I_F	100	mA
Peak Forward Current *1	I_{FP}	1.0	A
Reverse Voltage	V_R	5	V
Operating Temperature	T_{opr}	-40 ~ +85	$^\circ\text{C}$
Storage Temperature	T_{stg}	-40 ~ +85	$^\circ\text{C}$
Soldering Temperature *2	T_{sol}	260	$^\circ\text{C}$
Power Dissipation at(or below) 25 $^\circ\text{C}$ Free Air Temperature	P_d	150	mW

Notes: *1: I_{FP} Conditions--Pulse Width $\leq 100 \mu\text{s}$ and Duty $\leq 1\%$.

*2:Soldering time ≤ 5 seconds.

Electro-Optical Characteristics (Ta=25°C)

Parameter	Symbol	Condition	Min.	Typ.	Max.	Units
Radiant Intensity	E _e	I _F =20mA	7.8	20	--	mW/sr
		I _F =100mA Pulse Width ≤ 100 μs and Duty ≤ 1%	--	95	--	
		I _F =1A Pulse Width ≤ 100 μs and Duty ≤ 1%	--	920	--	
Peak Wavelength	λ _p	I _F =20mA	--	875	--	nm
Spectral Bandwidth	Δλ	I _F =20mA	--	80	--	nm
Forward Voltage	V _F	I _F =20mA	--	1.3	1.6	V
		I _F =100mA Pulse Width ≤ 100 μs and Duty ≤ 1%	--	1.4	1.8	
		I _F =1A Pulse Width ≤ 100 μs and Duty ≤ 1%	--	2.6	4.0	
Reverse Current	I _R	V _R =5V	--	--	10	μA
View Angle	2θ _{1/2}	I _F =20mA	--	20	--	deg

Typical Electro-Optical Characteristics Curves

Fig.1 Forward Current vs. Ambient Temperature

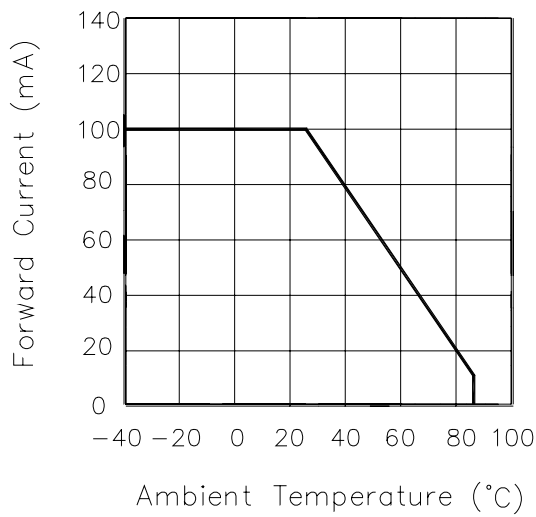

Fig.2 Spectral Distribution

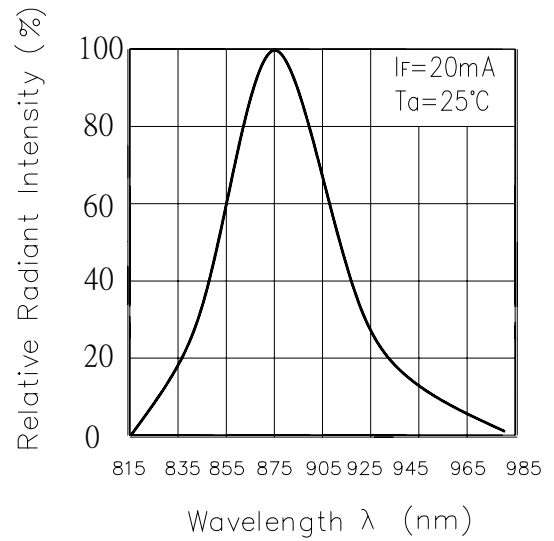

Fig.3 Peak Emission Wavelength vs. Ambient Temperature

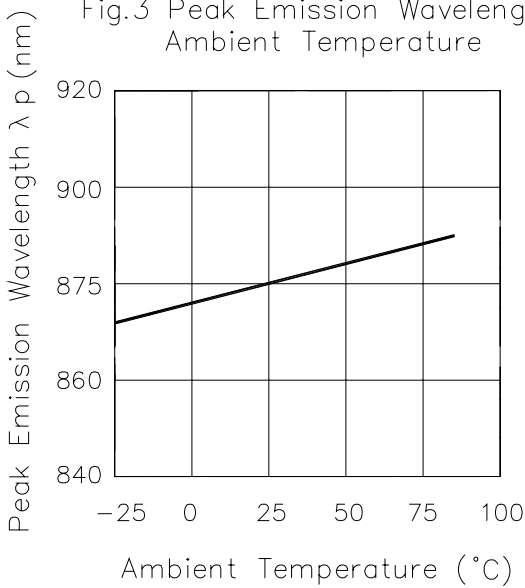
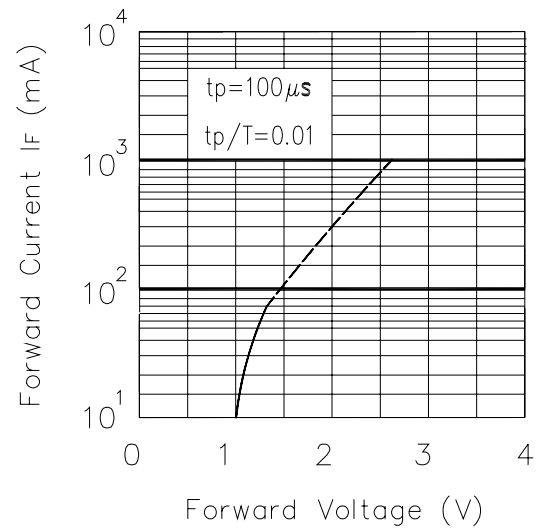

Fig.4 Forward Current vs. Forward Voltage



Typical Electro-Optical Characteristics Curves

Fig.5 Relative Intensity vs. Forward Current

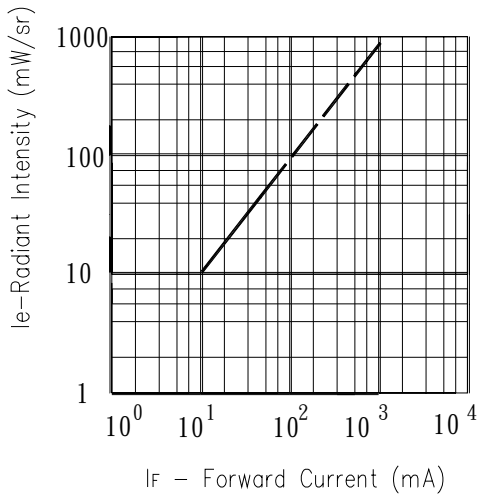

Fig.6 Relative Radiant Intensity vs. Angular Displacement

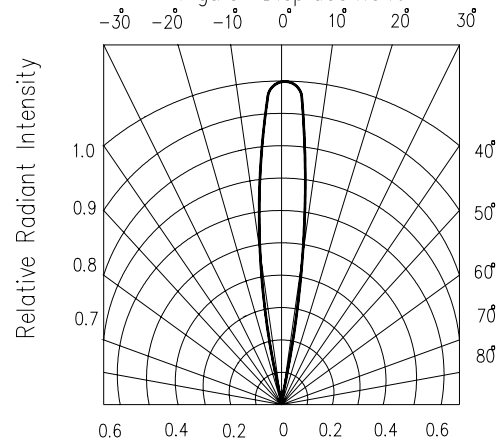

Fig.7 Relative Intensity vs. Ambient Temperature (°C)

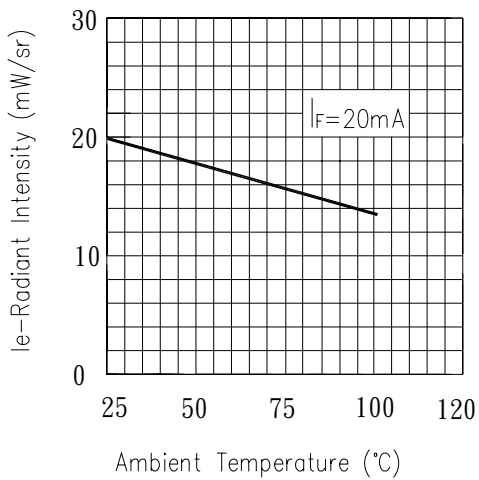
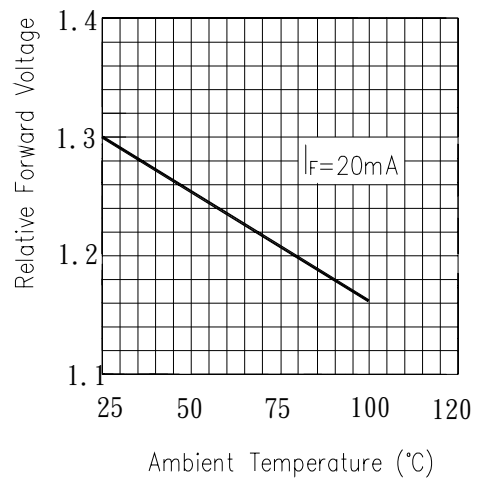

Fig.8 Forward Voltage vs. Ambient Temperature (°C)



Reliability Test Item And Condition

The reliability of products shall be satisfied with items listed below.

Confidence level : 90%

LTPD : 10%

NO.	Item	Test Conditions	Test Hours/ Cycles	Sample Sizes	Failure Judgement Criteria	Ac/R e
1	Solder Heat	TEMP. : 260°C±5°C	10 secs	22pcs	$I_R \geq U \times 2$ $E_e \leq L \times 0.8$ $V_F \geq U \times 1.2$ U : Upper Specification Limit L : Lower Specification Limit	0/1
2	Temperature Cycle	H : +100°C 15mins ↑ 5mins ↓ L : -40°C 15mins	300 Cycles	22pcs		0/1
3	Thermal Shock	H : +100°C 5mins ↑ 10secs ↓ L : -10°C 5mins	300 Cycles	22pcs		0/1
4	High Temperature Storage	TEMP. : +100°C	1000hrs	22pcs		0/1
5	Low Temperature Storage	TEMP. : -40°C	1000hrs	22pcs		0/1
6	DC Operating Life	$I_F = 20\text{mA}$	1000hrs	22pcs		0/1
7	High Temperature/ High Humidity	85°C / 85% R.H	1000hrs	22pcs		0/1

Packing Quantity Specification

1. 500Pcs/1Bag, 6 Bags/1Box
2. 10Boxes/1Carton

Label Form Specification

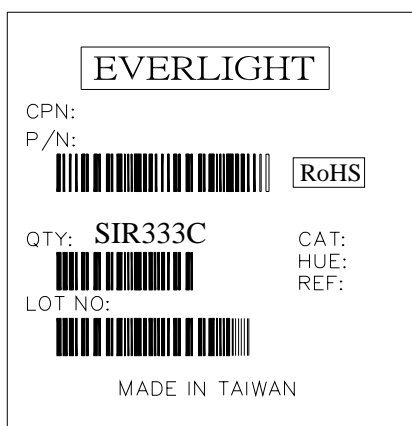

CPN: Customer's Production Number
P/N : Production Number
QTY: Packing Quantity
CAT: Ranks
HUE: Peak Wavelength
REF: Reference
LOT No: Lot Number
MADE IN TAIWAN: Production Place

Notes

1. Above specification may be changed without notice. EVERLIGHT will reserve authority on material change for above specification.
2. When using this product, please observe the absolute maximum ratings and the instructions for using outlined in these specification sheets. EVERLIGHT assumes no responsibility for any damage resulting from use of the product which does not comply with the absolute maximum ratings and the instructions included in these specification sheets.
3. These specification sheets include materials protected under copyright of EVERLIGHT corporation. Please don't reproduce or cause anyone to reproduce them without EVERLIGHT's consent.

EVERLIGHT ELECTRONICS CO., LTD.
Office: No 25, Lane 76, Sec 3, Chung Yang Rd,
Tucheng, Taipei 236, Taiwan, R.O.C

Tel: 886-2-2267-2000, 2267-9936
Fax: 886-2267-6244, 2267-6189, 2267-6306
<http://www.everlight.com>