

**MOTOROLA**  
**SEMICONDUCTOR**  
**TECHNICAL DATA**
*Designer's Data Sheet*
**Power Field Effect Transistors**
**N-Channel Enhancement Mode**
**Silicon Gate**
**PAK for Surface Mount or Insertion Mount**

These TMOS Power FETs are designed for high speed, low loss power switching applications such as switching regulators, converters, solenoid and relay drivers.

- Silicon Gate for Fast Switching Speeds
- Low  $R_{DS(on)}$  — 0.4  $\Omega$  max
- Rugged — SOA is Power Dissipation Limited
- Source-to-Drain Diode Characterized for Use With Inductive Loads
- Low Drive Requirement —  $V_{GS(th)}$  = 4 V max
- Surface Mount Package on 16 mm Tape
- Available With Long Leads, Add -1 Suffix

**MAXIMUM RATINGS**

Rating	Symbol	MTD5N05	MTD5N06	Unit
Drain-Source Voltage	$V_{DSS}$	50	60	Vdc
Drain-Gate Voltage ( $R_{GS} = 1 \text{ M}\Omega$ )	$V_{DGR}$	50	60	Vdc
Gate-Source Voltage — Continuous	$V_{GS}$	$\pm 20$		Vdc
— Non-repetitive ( $t_p \leq 50 \mu\text{s}$ )	$V_{GSM}$	$\pm 40$		Vpk
Drain Current — Continuous	$I_D$	5		Adc
— Pulsed	$I_{DM}$	14		
Total Power Dissipation @ $T_C = 25^\circ\text{C}$	$P_D$	20		Watts
Derate above $25^\circ\text{C}$		0.16		$\text{W}/^\circ\text{C}$
Total Power Dissipation @ $T_A = 25^\circ\text{C}$	$P_D$	1.25		Watts
Derate above $25^\circ\text{C}$		0.01		$\text{W}/^\circ\text{C}$
Total Power Dissipation @ $T_A = 25^\circ\text{C}$ (1)	$P_D$	1.75		Watts
Derate above $25^\circ\text{C}$		0.014		$\text{W}/^\circ\text{C}$
Operating and Storage Junction Temperature Range	$T_J, T_{stg}$	-65 to +150		$^\circ\text{C}$

**THERMAL CHARACTERISTICS**

Thermal Resistance — Junction to Case	$R_{\theta JC}$	6.25	$^\circ\text{C}/\text{W}$
	— Junction to Ambient	$R_{\theta JA}$	100
	— Junction to Ambient (1)		71.4

**ELECTRICAL CHARACTERISTICS** ( $T_C = 25^\circ\text{C}$  unless otherwise noted)

Characteristic	Symbol	Min	Max	Unit
----------------	--------	-----	-----	------

**OFF CHARACTERISTICS**

Drain-Source Breakdown Voltage ( $V_{GS} = 0, I_D = 0.25 \text{ mA}$ )	MTD5N05	$V_{(BR)DSS}$	50	—	Vdc
	MTD5N06		60	—	
Zero Gate Voltage Drain Current ( $V_{DS} = 0.8 \text{ Rated } V_{DSS}, V_{GS} = 0$ ) $T_J = 125^\circ\text{C}$		$I_{DSS}$	—	0.2 1	mAdc

(1) These ratings are applicable when surface mounted on the minimum pad size recommended (continued)

**Designer's Data for "Worst Case" Conditions** — The Designer's Data Sheet permits the design of most circuits entirely from the information presented. Limit curves — representing boundaries on device characteristics — are given to facilitate "worst case" design.

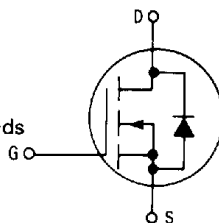
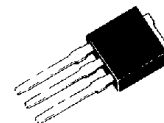
**MTD5N05**  
**MTD5N06**
**TMOS POWER FETs**  
**5 AMPERES**  
 $R_{DS(on)} = 0.4 \text{ OHM}$   
**50 and 60 VOLTS**

**CASE 369A-10**  
**MTD5N05**  
**MTD5N06**

**CASE 369-06**  
**MTD5N05-1**  
**MTD5N06-1**

**ELECTRICAL CHARACTERISTICS — continued** ( $T_C = 25^\circ\text{C}$  unless otherwise noted)

Characteristic	Symbol	Min	Max	Unit
----------------	--------	-----	-----	------

**OFF CHARACTERISTICS — continued**

Gate-Body Leakage Current, Forward ( $V_{GSF} = 20\text{ Vdc}$ , $V_{DS} = 0$ )	$I_{GSSF}$	—	100	nAdc
Gate-Body Leakage Current, Reverse ( $V_{GSR} = 20\text{ Vdc}$ , $V_{DS} = 0$ )	$I_{GSSR}$	—	100	nAdc

**ON CHARACTERISTICS\***

Gate Threshold Voltage ( $V_{DS} = V_{GS}$ , $I_D = 1\text{ mA}$ ) $T_J = 100^\circ\text{C}$	$V_{GS(th)}$	2 1.5	4.5 4	Vdc
Static Drain-Source On-Resistance ( $V_{GS} = 10\text{ Vdc}$ , $I_D = 2.5\text{ Adc}$ )	$R_{DS(on)}$	—	0.4	Ohm
Drain-Source On-Voltage ( $V_{GS} = 10\text{ V}$ ) ( $I_D = 5\text{ Adc}$ ) ( $I_D = 2.5\text{ Adc}$ , $T_J = 100^\circ\text{C}$ )	$V_{DS(on)}$	— —	2.4 2	Vdc
Forward Transconductance ( $V_{DS} = 15\text{ V}$ , $I_D = 2.5\text{ A}$ )	$g_{FS}$	1	—	mhos

**DYNAMIC CHARACTERISTICS**

Input Capacitance	$(V_{DS} = 25\text{ V}$ , $V_{GS} = 0$ , $f = 1\text{ MHz}$ ) See Figure 11	$C_{iss}$	—	300	pF
Output Capacitance		$C_{oss}$	—	160	
Reverse Transfer Capacitance		$C_{rss}$	—	50	

**SWITCHING CHARACTERISTICS\* ( $T_J = 100^\circ\text{C}$ )**

Turn-On Delay Time	$(V_{DD} = 25\text{ V}$ , $I_D = 0.5\text{ Rated } I_D$ $R_{gen} = 50\text{ ohms}$ ) See Figures 13 and 14	$t_{d(on)}$	—	25	ns
Rise Time		$t_r$	—	25	
Turn-Off Delay Time		$t_{d(off)}$	—	50	
Fall Time		$t_f$	—	50	
Total Gate Charge	$(V_{DS} = 0.8\text{ Rated } V_{DSS}$ , $I_D = \text{Rated } I_D$ , $V_{GS} = 10\text{ V}$ ) See Figure 12	$Q_g$	6 (Typ)	15	nC
Gate-Source Charge		$Q_{gs}$	3 (Typ)	—	
Gate-Drain Charge		$Q_{gd}$	3 (Typ)	—	

**SOURCE DRAIN DIODE CHARACTERISTICS\***

Forward On-Voltage	$(I_S = \text{Rated } I_D$ $V_{GS} = 0$ )	$V_{SD}$	2 (Typ)	3	Vdc
Forward Turn-On Time		$t_{on}$	Limited by stray inductance		
Reverse Recovery Time		$t_{rr}$	300 (Typ)	—	ns

\*Pulse Test: Pulse Width  $\leq 300\ \mu\text{s}$ , Duty Cycle  $\leq 2\%$

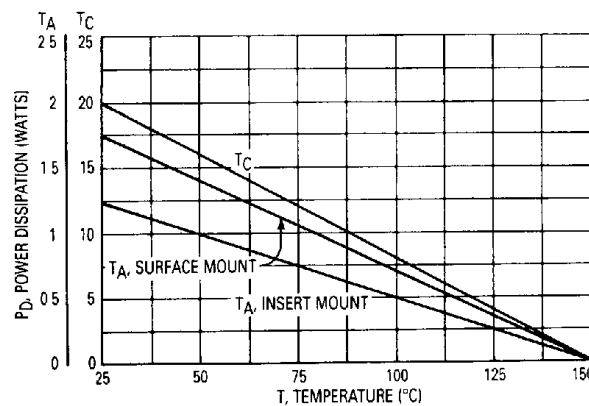

Figure 1. Power Derating

3

TYPICAL ELECTRICAL CHARACTERISTICS

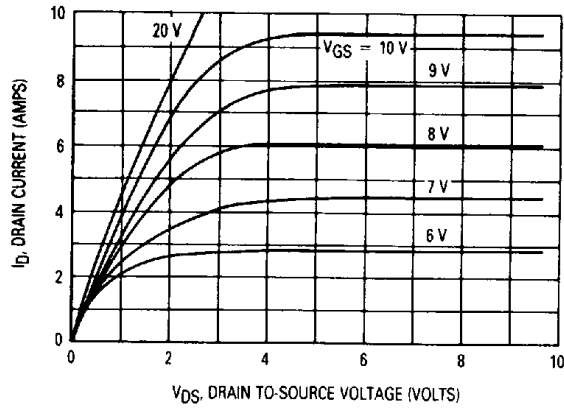

Figure 2. On-Region Characteristics

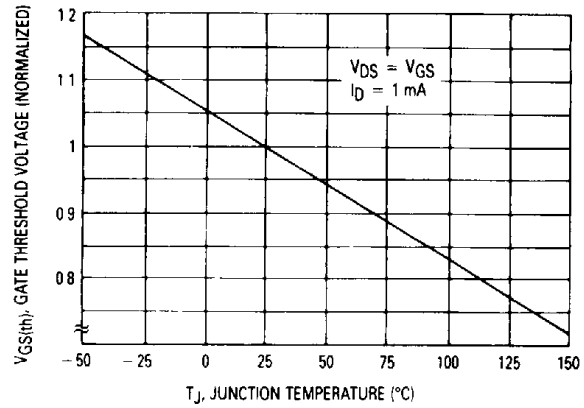

Figure 3. Gate-Threshold Voltage Variation With Temperature

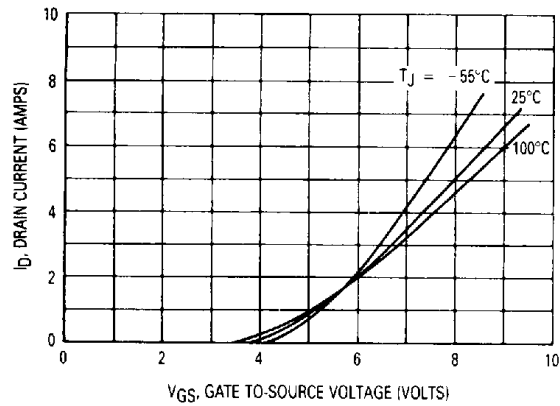

Figure 4. Transfer Characteristics

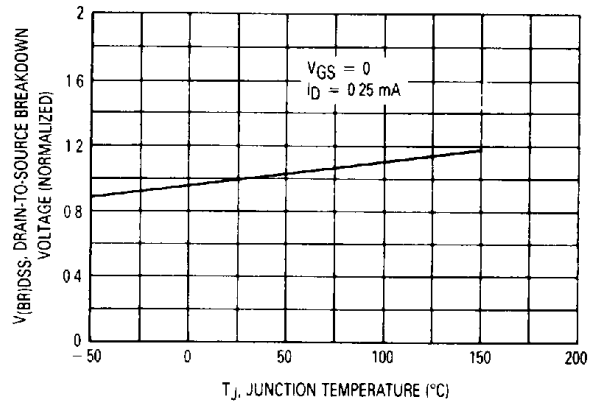

Figure 5. Breakdown Voltage Variation With Temperature

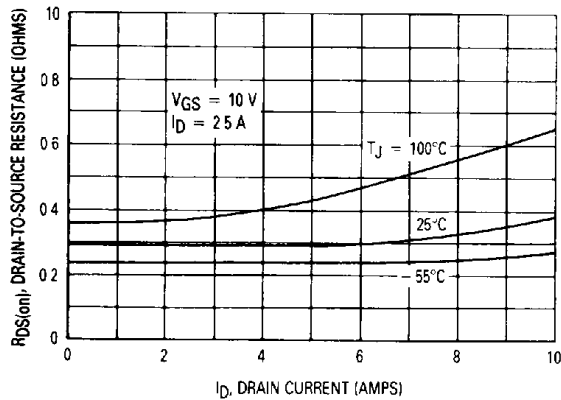

Figure 6. On-Resistance versus Drain Current

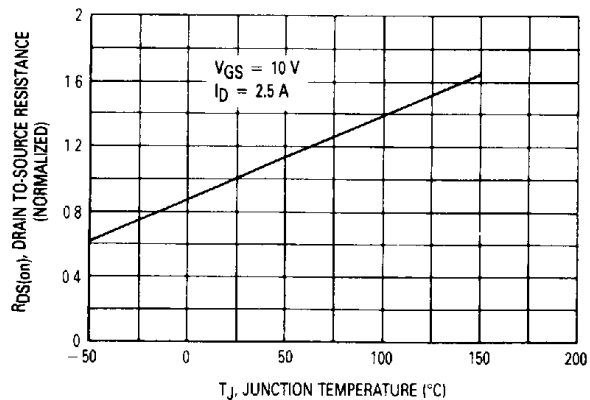

Figure 7. On-Resistance Variation With Temperature

SAFE OPERATING AREA INFORMATION

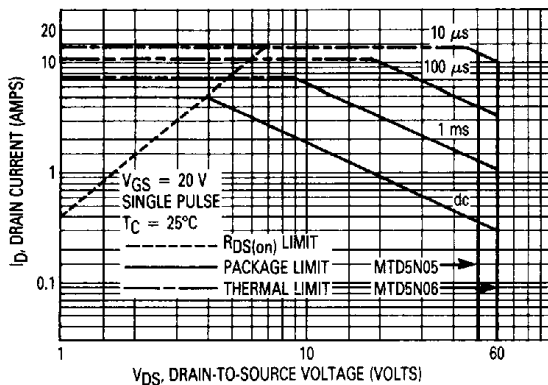

Figure 8. Maximum Rated Forward Biased Safe Operating Area

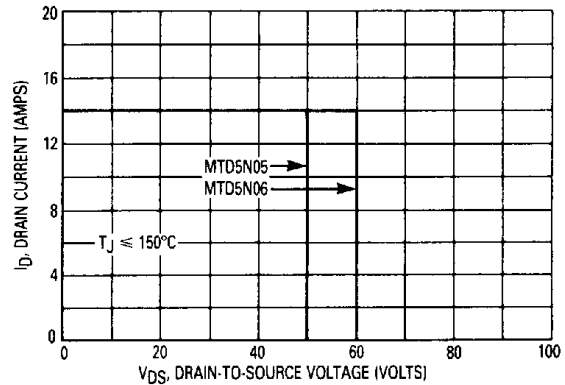

Figure 9. Maximum Rated Switching Safe Operating Area

3

FORWARD BIASED SAFE OPERATING AREA

The FBSOA curves define the maximum drain-to-source voltage and drain current that a device can safely handle when it is forward biased, or when it is on, or being turned on. Because these curves include the limitations of simultaneous high voltage and high current, up to the rating of the device, they are especially useful to designers of linear systems. The curves are based on a case temperature of 25°C and a maximum junction temperature of 150°C. Limitations for repetitive pulses at various case temperatures can be determined by using the thermal response curves. Motorola Application Note, AN569, "Transient Thermal Resistance-General Data and Its Use" provides detailed instructions.

SWITCHING SAFE OPERATING AREA

The switching safe operating area (SOA) of Figure 9 is the boundary that the load line may traverse without incurring damage to the MOSFET. The fundamental limits are the peak current,  $I_{DM}$  and the breakdown voltage,  $V_{(BR)DSS}$ . The switching SOA shown in Figure 9 is applicable for both turn-on and turn-off of the devices for switching times less than one microsecond.

The power averaged over a complete switching cycle must be less than:

$$\frac{T_{J(max)} - T_C}{R_{\theta JC}}$$

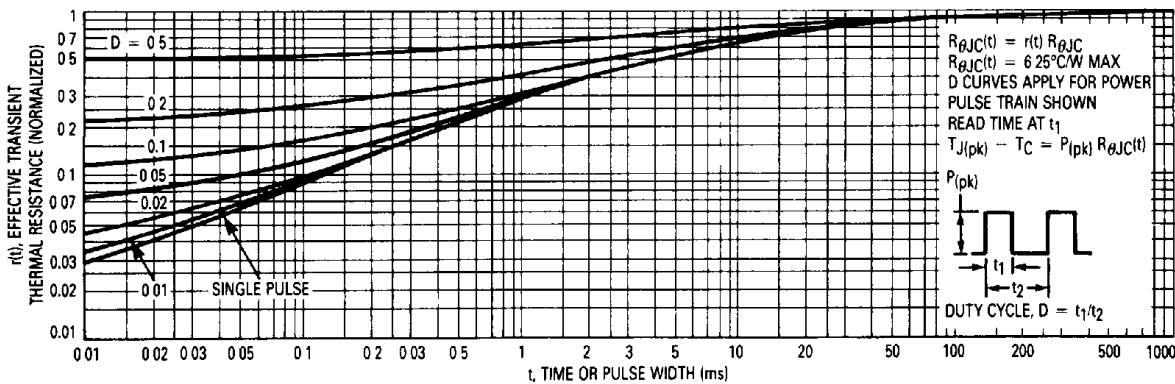

Figure 10. Thermal Response

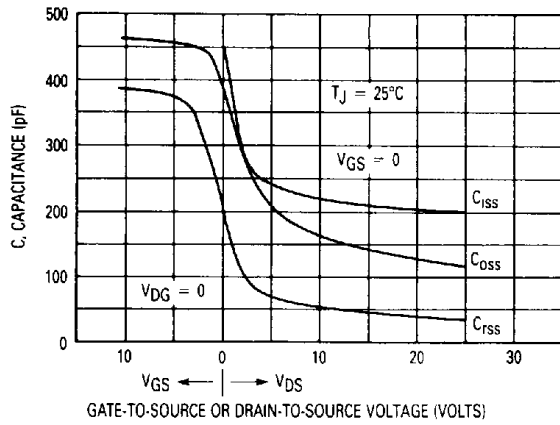

Figure 11. Capacitance Variation

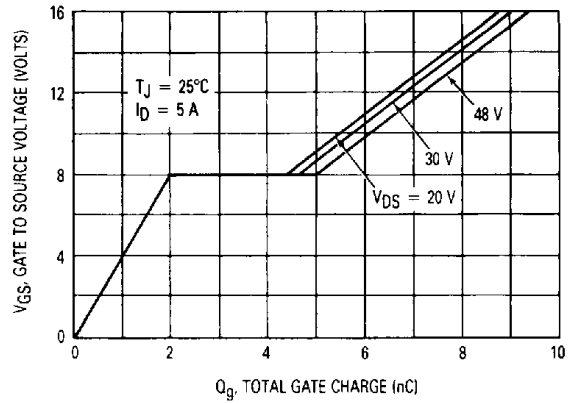

Figure 12. Gate Charge versus Gate-to-Source Voltage

RESISTIVE SWITCHING

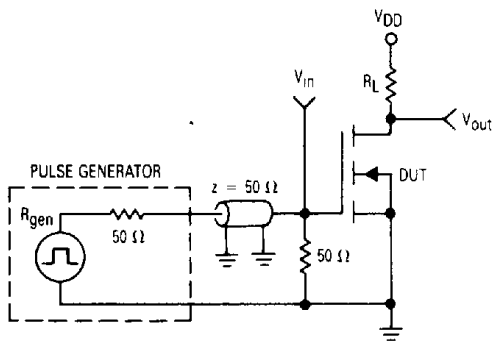

Figure 13. Switching Test Circuit

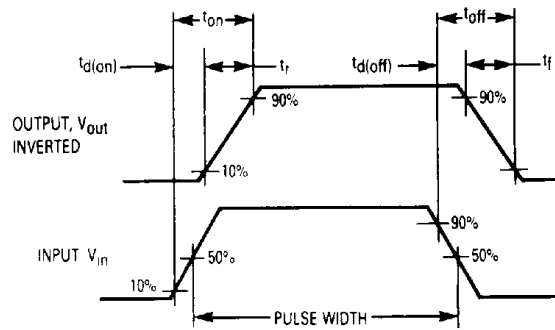

Figure 14. Switching Waveforms