

**RS Series Relay Modules**

At only 6.2mm thickness the RS series Relay module features a slim Din Rail mountable interface solution. The modules have a plug in construction and are available with or without the relay. The built in LED indicates the relay energizing state. The relay features a SPDT configuration and a maximum switching current of 6A. It is available with several standard coil voltages from 5VAC/DC up to 230V AC/DC.

There is a provision for fitting pluggable jumpers which reduces the wiring time. The modules have screw terminals with finger protection for wire termination and offer an IP 20 protection rating. The relay has an IP67 protection rating. Both the relay and the module are UL recognized.

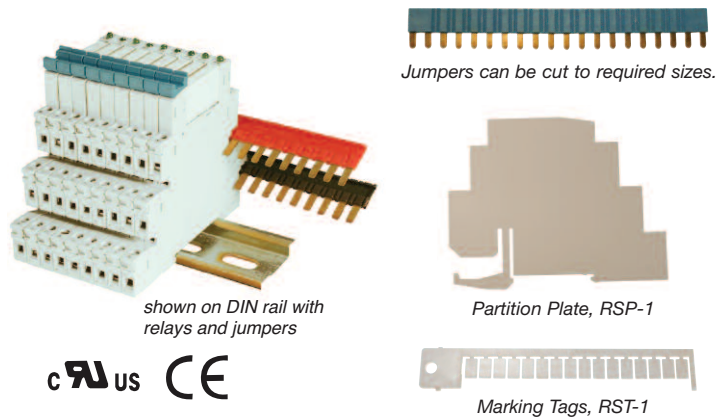

Part Number	Type number	Description	Std. Pk.
RSM-05CU	41F-1Z-C2-5 + HF41F/5-Z-S	6A@250VAC/30VDC,5VDC Coil, 6.2 mm, LED, SPDT	10
RSM-06CU	41F-1Z-C2-5 + HF41F/6-Z-S	6A@250VAC/30VDC,6VDC Coil, 6.2 mm, LED, SPDT	10
RSM-12CU	41F-1Z-C2-1 + HF41F/12-Z-S	6A@250VAC/30VDC,12VAC/DC Coil, 6.2 mm, LED, SPDT	10
RSM-24CU	41F-1Z-C2-1 + HF41F/24-Z-S	6A@250VAC/30VDC,24VAC/DC Coil, 6.2 mm, LED, SPDT	10
RSM-110CU	41F-1Z-C2-3 + HF41F/60-Z-S	6A@250VAC/30VDC,110VAC/DC Coil, 6.2mm, LED, SPDT	10
RSM-220CU	41F-1Z-C2-4 + HF41F/60-Z-S	6A@250VAC/30VDC,220VAC/DC Coil, 6.2mm, LED, SPDT	10
RSJ-RD	HF41F-AAJ-001-RD	Jumper for RSM, Red, 36A, 250V, 20 pole	10
RSJ-BK	HF41F-AAJ-001-BK	Jumper for RSM, Black, 36A, 250V, 20 pole	10
RSJ-BL	HF41F-AAJ-001-BL	Jumper for RSM, Blue, 36A, 250V, 20 pole	10
RSP-1	HF41F-AAS-001	Partition plate for RMS 2.2mm wide	10
RST-1	HF41F-AAT-001	Marking Tag strip for RSM, white, (16 tags per strip)	4

**RS Series Socket**

**CHARACTERISTICS**

Ambient Temperature:	-40°C to +70°C (-40°F to +158°F)
Rated Voltage:	250VAC
Rated Current:	6A (per pole)
Insulation Voltage (Min.):	5000VAC
Protection:	IP20
Socket Material:	PA66+GF V0 (UL)
Contacts Spring Material:	QSn6.5-0.1
Terminal Torque:	0.6Nm (5.3 lb. in.)
Wire Strip Length:	7mm
Applicable Relay Type:	RSR Series (41F)



File No.: E253370

**Notes: Module features/ functions:**

- (1) LED indicates the coil energizing state.
- (2) Eliminates negative current of relays.
- (3) Rectifying function (only for VAC/DC types).

Part Number	Type number	Description
RSS-624U	41F-1Z-C2-1-555	For 12 to 24VAC/DC relays, IP20, LED
RSS-624D	41F-1Z-C2-5-555	For 5 to 24VDC relays, IP20, LED
RSS-4860U	41F-1Z-C2-2-555	For 48 to 60VAC/DC relays, IP20, LED
RSS-110U	41F-1Z-C2-3-555	For 110 to 125 VAC/DC relays, IP20, LED
RSS-220U	41F-1Z-C2-4-555	For 220 to 240 VAC/DC relays, IP20, LED

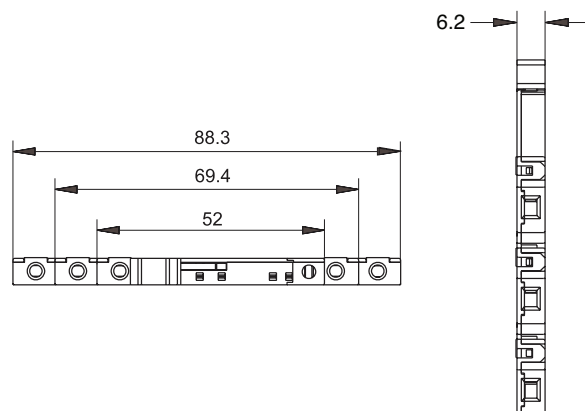
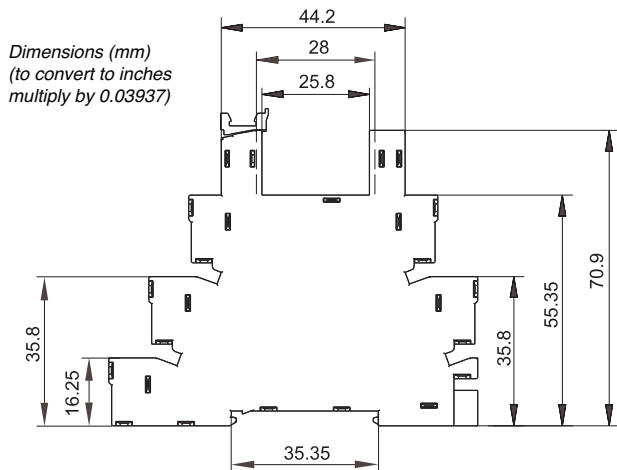

## RS Series Subminiature Power Relay

### FEATURES

- Slim size (width 5mm)
- High breakdown voltage 4kV (between coil and contacts)
- Surge voltage up to 6kV (between coil and contacts)
- Clearance/creepage distance: 8mm
- Coil power consumption: 170mW
- Contact configuration: SPDT (Form C)
- Environmental friendly product (RoHS compliant)
- Outline Dimensions: 28.0 x 5.0 x 15.0mm



**cRU US**  
File No.:E133481



File No.:40020043

### CONTACT INFORMATION

Contact arrangement	SPDT	
Initial contact Resistance Max.	100mΩ (at 1A/6VDC)	Gold plated: 30mΩ (at 1A/6VDC)
Contact material	AgNi	
Contact rating	Resistive Load	6A/250VAC
	Pilot Duty	6A/30VDC
		R300
Max. switching voltage	400VAC / 125VDC	
Max. switching current	6A resistive	
Max. switching power	1500VA / 180W	
Mechanical life	10 million cycles	
Electrical life	10,000 cycles at 85°C (185°F)	

Part Number	Type number	Description
RSR-05DCS	HF41F/5-Z-S-210	SPDT, 5 mm, 5VDC Coil, IP67
RSR-06DCS	HF41F/6-Z-S-210	SPDT, 5 mm, 6VDC Coil, IP67
RSR-12DCS	HF41F/12-Z-S-210	SPDT, 5 mm, 12VDC Coil, IP67
RSR-24DCS	HF41F/24-Z-S-210	SPDT, 5 mm, 24VDC Coil, IP67
RSR-48DCS	HF41F/48-Z-S-210	SPDT, 5 mm, 48VDC Coil, IP67
RSR-60DCS	HF41F/60-Z-S-210	SPDT, 5 mm, 60VDC Coil, IP67

### Contact Configuration 1 Form SPDT

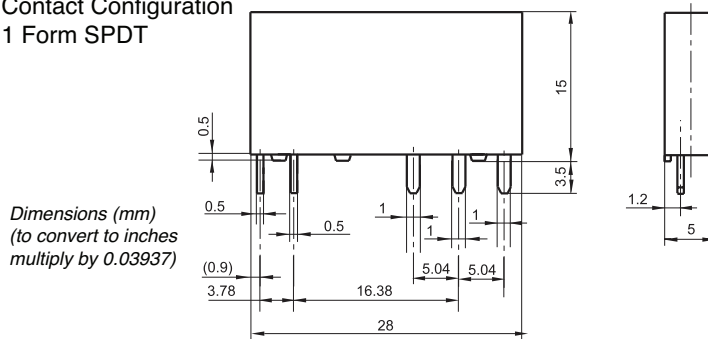

### Wiring Diagram

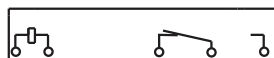

### PCB Layout

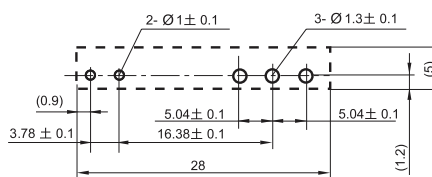

### CHARACTERISTICS

Initial insulation resistance	1000mΩ (at 500VDC)	
Dielectric strength	Between coil & contacts	4000VAC 1 min.
	Between open contacts	1000VAC 1 min.
Operate time (at nominal voltage)	Max. 8ms	
Release time (at nominal voltage)	Max. 4ms	
Shock resistance	Functional	50m/s <sup>2</sup> (5g)
	Destructive	1000m/s <sup>2</sup> (100g)
Vibration resistance	1mm double amplitude max @10 ...55 Hz, 6G max	
Humidity	5 to 85% RH	
Ambient temperature	-40°C to +85°C (-40°F to +185°F)	
Termination	Plug in; PCB mount	
Unit weight	5.4g (0.2 oz.)	
Construction	Sealed IP67. Flux proof	

### COIL

Coil power consumption:	5 to 24VDC: 170mW 48VDC, 60VDC: 210mW
-------------------------	--

### COIL DATA

at 20°C

Nominal Voltage (VDC)	Pick-up Voltage (VDC)	Drop-out Voltage (VDC)	Max. Allowable Voltage (VDC) 85°C	Coil Resistance (Ω)
5	3.75	0.25	6.50	147 ± 10%
6	4.50	0.30	7.80	212 ± 10%
12	9.00	0.60	15.6	848 ± 10%
24	18.0	1.20	31.2	3390 ± 15%
48	36.0	2.40	62.4	10600 ± 15%
60	45.0	3.00	78.0	16600 ± 15%

### MAXIMUM SWITCHING POWER

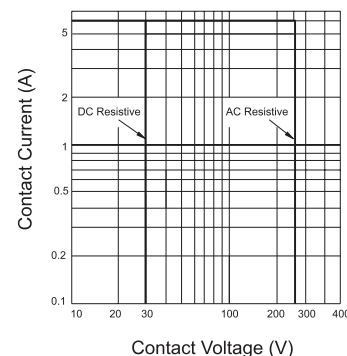

### ENDURANCE CURVE

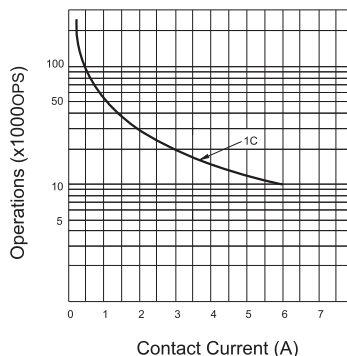

### COIL TEMPERATURE RISE

