



Hi-Rel DC/DC CONVERTER MGDM-20 : 20W POWER

Hi-Rel
Grade ■■■

Single, Bi & Triple Outputs
Metallic Case - 1.500 VDC Isolation

- 28Vdc input compliant with MIL-STD-704 D/E
- Nominal power up to 20 W
- Wide temperature range : -40°C/+105°C case
- High efficiency (typ. 84%)
- Soft start
- Galvanic isolation 1.500 VDC
- Integrated LC EMI filter
- Permanent short circuit protection
- No optocoupler for high reliability



1-General

The MGDM-20 series is a complete line of high performance DC/DC power modules designed for aerospace, military and high-end industrial applications. These modules use a high frequency fixed switching technic at 500KHz providing excellent reliability, low noise characteristics and high power density. Standard models are available with standard input voltage range of 4.5-5.5, 9-36 and 16-40 volts. The series include single bi and triple output voltage choices of 3,3 , 5, 12, 15 volts.

No external heatsink is required for the MGDM-20 series to supply 20W output power over the full temperature range.

All the modules are designed with LC network filters to minimize reflected input current ripple and output voltage ripple.

The modules include a soft-start, and a permanent short circuit protection to ensure efficient module protection. The soft-start allows current limitation and eliminates inrush current during start-up. The short circuit protection completely protects the modules against short-circuits of any duration by a shut-down and restores to normal when the overload is removed.

The design has been carried out with surface mount components and is manufactured in a fully automated process to guarantee high quality. Each module is tested with a GAIA converter automated test equipment. The modules are potted with a bi-component thermal conductive compound and packaged in a metallic case to ensure the module's integrity under high environmental conditions.

4

2-Product Selection

Single output model : MGDS-20- — (/T) and/or (/S)
 Bi output model : MGDB-20- — (/T) and/or (/S)
 Triple output model : MGDT-20- — (/T) and/or (/S)

(/T) : option for -55°C start up operating temperature
 (/S) : option for screening and serialization

Input Voltage Range	
Permanent	Transient
C : 4,5-5,5 VDC	n/a
H : 9-36 VDC	40 VDC/100 ms*
J : 16-40 VDC	50 VDC/100 ms*

Output
B : 3.3 VDC
C : 5 VDC or +/-5VDC
E : 12 VDC or +/-12VDC
F : 15 VDC or +/-15VDC
BE : 3,3 VDC and +/-12 VDC
BF : 3,3 VDC and +/-15 VDC
CE : 5 VDC and +/-12 VDC
CF : 5 VDC and +/-15 VDC

* Consult factory for details

2- Product Selection (continued)

Input range	Output	Current	Reference	Options
4,5-5,5 VDC	3,3 VDC	4 A	MGDS-20-C-B	/T, /S
4,5-5,5 VDC	5 VDC	4 A	MGDS-20-C-C	/T, /S
4,5-5,5 VDC	12 VDC	1,6 A	MGDS-20-C-E	/T, /S
4,5-5,5 VDC	15 VDC	1,3 A	MGDS-20-C-F	/T, /S
9-36 VDC	3,3 VDC	4 A	MGDS-20-H-B	/T, /S
9-36 VDC	5 VDC	4 A	MGDS-20-H-C	/T, /S
9-36 VDC	12 VDC	1,6 A	MGDS-20-H-E	/T, /S
9-36 VDC	15 VDC	1,3 A	MGDS-20-H-F	/T, /S
9-36 VDC	+/- 5 VDC	+/- 2A	MGDB-20-H-C	/T, /S
9-36 VDC	+/- 12 VDC	+/- 0,8 A	MGDB-20-H-E	/T, /S
9-36 VDC	+/- 15 VDC	+/- 0,65 A	MGDB-20-H-F	/T, /S
9-36 VDC	3,3 & +/- 12 VDC	2 A & +/- 0,4 A	MGDT-20-H-BE	/T, /S
9-36 VDC	3,3 & +/- 15 VDC	2 A & +/- 0,3 A	MGDT-20-H-BF	/T, /S
9-36 VDC	5 & +/- 12 VDC	2 A & +/- 0,4 A	MGDT-20-H-CE	/T, /S
9-36 VDC	5 & +/- 15 VDC	2 A & +/- 0,3 A	MGDT-20-H-CF	/T, /S
16-40 VDC	3,3 VDC	4 A	MGDS-20-J-B	/T, /S
16-40 VDC	5 VDC	4 A	MGDS-20-J-C	/T, /S
16-40 VDC	12 VDC	1,6 A	MGDS-20-J-E	/T, /S
16-40 VDC	15 VDC	1,3 A	MGDS-20-J-F	/T, /S
16-40 VDC	+/- 5 VDC	+/- 2A	MGDB-20-J-C	/T, /S
16-40 VDC	+/- 12 VDC	+/- 0,8 A	MGDB-20-J-E	/T, /S
16-40 VDC	+/- 15 VDC	+/- 0,65 A	MGDB-20-J-F	/T, /S
16-40 VDC	3,3 & +/- 12 VDC	2 A & +/- 0,4 A	MGDT-20-J-BE	/T, /S
16-40 VDC	3,3 & +/- 15 VDC	2 A & +/- 0,3 A	MGDT-20-J-BF	/T, /S
16-40 VDC	5 & +/- 12 VDC	2 A & +/- 0,4 A	MGDT-20-J-CE	/T, /S
16-40 VDC	5 & +/- 15 VDC	2 A & +/- 0,3 A	MGDT-20-J-CF	/T, /S

www.DataSheet4U.com

4

Converter Selection Chart

MGDS - 20 - H - C / T

Number of Outputs :

- S : single output
- B : bi ouput
- T : triple output

Input voltage range :

- C : 4,5-5,5 VDC
- H : 9-36 VDC
- J : 16-40 VDC

Output voltage :

See table page 1

Option :

- /T : -55°C start up operation
- /S: screening and serialization (consult application note «screening grades»)

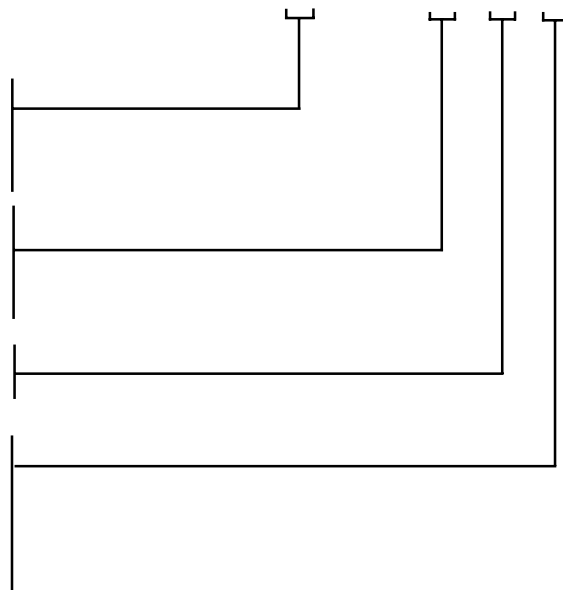

3- Electrical Specifications

Data are valid at +25°C, unless otherwise specified.

Parameter	Conditions	Limit or typical	Units	Single Output MGDS-20			
				20 - C	20 - H	20 - J	
Input							
Nominal input voltage	Full temperature range	Nominal	VDC	5	20	28	
Permanent input voltage range (Ui)	Full temperature range	Min. - Max.	VDC	4,5-5,5	9-36	16-40	
Transient input voltage	Full load (Consult factory)	Maximum	VDC/S	/	40/0,1	50/0,1	
Start up input voltage	Full load	Minimum	VDC	4,3	8,5	15,5	
Start up time	Ui nominal Nominal output Full load : resistive	Maximum	ms	40	40	40	
Reflected ripple current	Ui nominal, full load at switching freq. BW = 20MHz	Maximum	mApp	50	50	50	
Input current in short circuit mode (Average)	Ui nominal Short-circuit	Maximum	mA	100	60	60	
No load input current	Ui nominal No load	Maximum	mA	100	60	60	
Output							
Output voltage *	Full temperature range	Nominal	VDC	3,3	3,3	3,3	
	Ui min. to max.	Nominal	VDC	5	5	5	
	75% load	Nomina	VDC	12	12	12	
		Nominall	VDC	15	15	15	
Set Point accuracy	Ambient temperature : +25°C Ui nominal, 75% load	Maximum	%	+/- 2	+/- 2	+/- 2	
Output power	Full temperature range Ui min. to max.	Maximum	W	20	20	20	
Output current **	Full temperature range Ui min. to max.	Maximum	mA	3,3V output	4.000	4.000	4.000
5V output				4.000	4.000	4.000	
12V output				1.600	1.600	1.600	
15V output				1.300	1.300	1.300	
Ripple output voltage ***				Ui nominal	Maximum	mVpp	40
3,3V and 5V output	Full load	Maximum	mVpp	50	50	50	
12V output	BW = 20MHz	Maximum	mVpp	60	60	60	
15V output				60	60	60	
Line regulation	Ui min. to max. Full load	Maximum	%	+/- 1	+/- 1	+/- 1	
Load regulation	Ui nominal 25% to full load	Maximum	%	+/- 2	+/- 2	+/- 2	
Efficiency	Ui nominal Full load	Typical	%	See on page 6			
Maximum admissible Capacity load	Ui nominal	Maximum	µF	2.000	2.000	2.000	
3,3V and 5V output	Full load						
12V and 15V output	Per output						680

Note * : For proper operation the MGDM-20 module requires to install a 22µF chemical or tantalum capacitor across output terminal.

Note ** : For 9-36V input range, the current is derated at 80% at 9V and increases linearly to full current at 12V.

Note*** : The ripple output voltage is the periodic AC component imposed on the output voltage, an aperiodic and random component (noise) has also to be considered. This noise can be reduced by adding an external capacitance (typically 10nF/rated voltage depending on isolation requirement) connected between the pin Gin and the pin Gout of the converter. This capacitance should be layed-out as close as possible from the converter.

3- Electrical Characteristics (continued)

Data are valid at +25°C, unless otherwise specified.

Parameter	Conditions	Limit or typical	Units	Bi Output MGDB-20	
				20 - H	20 - J
Input					
Nominal input voltage	Full temperature range	Nominal	VDC	20	28
Permanent input voltage range (Ui)	Full temperature range	Min. - Max.	VDC	9-36	16-40
Transient input voltage	Full load (Consult factory)	Maximum	VDC/S	40/0,1	50/0,1
Start up input voltage	Full load	Minimum	VDC	8,5	15,5
Start up time	Ui nominal Nominal output Full load : resistive	Maximum	ms	40	40
Reflected ripple current	Ui nominal, full load at switching freq. BW = 20MHz	Maximum	mApp	50	50
Input current in short circuit mode (Average)	Ui nominal Short-circuit	Maximum	mA	60	60
No load input current	Ui nominal No load	Maximum	mA	60	60
Output					
Output voltage *	Full temperature range	Nominal	VDC	+/- 5	+/- 5
	Ui min. to max.	Nominal	VDC	+/- 12	+/- 12
	75% load	Nominal	VDC	+/- 15	+/- 15
Set Point accuracy	Ambient temperature : +25°C Ui nominal, 75% load	Maximum	%	+/- 2	+/- 2
Output power	Full temperature range Ui min. to max.	Maximum	W	+/- 10	+/- 10
Output current **	Full temperature range	Maximum	mA	+/- 2.000	+/- 2.000
	Ui min. to max.	Maximum	mA	+/- 800	+/- 800
		Maximum	mA	+/- 650	+/- 650
Ripple output voltage ***	Ui nominal	Maximum	mVpp	40	40
	Full load	Maximum	mVpp	50	50
	BW = 20MHz	Maximum	mVpp	60	60
Line regulation	Ui min. to max. Full load	Maximum	%	+/- 1	+/- 1
Load regulation	Ui nominal 25% to full load	Maximum	%	+/- 2	+/- 2
Cross load output regulation	Ui nominal + Vout nominal load - Vout from 25% to full load	Maximum	%	+/- 0,5	+/- 0,5
Efficiency	Ui nominal Full load	Typical	%	See on page 6	
Maximum admissible Capacity load	Ui nominal				
	Full load	Maximum	µF	1.000	1.000
	Per output	Maximum	µF	330	330

Note * : For proper operation the MGDM-20 module requires to install a 22µF chemical or tantalum capacitor across output terminal.

Note ** : For 9-36V input range, the current is derated at 80% at 9V and increases linearly to full current at 12V.

Note*** : The ripple output voltage is the periodic AC component imposed on the output voltage, an aperiodic and random component (noise) has also to be considered. This noise can be reduced by adding an external capacitance (typically 10nF/rated voltage depending on isolation requirement) connected between the pin Gin and the pin Gout of the converter. This capacitance should be layed-out as close as possible from the converter.

3- Electrical Characteristics (continued)

Data are valid at +25°C, unless otherwise specified.

Parameter	Conditions	Limit or typical	Units	Tri Output MGDM-20	
				20 - H	20 - J
Input					
Nominal input voltage	Full temperature range	Nominal	VDC	20	28
Permanent input voltage range (Ui)	Full temperature range	Min. - Max.	VDC	9-36	16-40
Transient input voltage	Full load	Maximum	VDC/S	40/0,1	50/0,1
Start up input voltage	Full load	Minimum	VDC	8,5	15,5
Start up time	Ui nominal Nominal output Full load : resistive	Maximum	ms	40	40
Reflected ripple current	Ui nominal, full load at switching freq. BW = 20MHz	Maximum	mApp	50	50
Input current in short circuit mode (Average)	Ui nominal Short-circuit	Maximum	mA	60	60
No load input current	Ui nominal No load	Maximum	mA	60	60
Output					
Output voltage *	Full temperature range Ui min. to max. 75% load	Nominal	VDC	3,3 & +/- 12	3,3 & +/- 12
		Nominal	VDC	3,3 & +/- 15	3,3 & +/- 15
		Nominal	VDC	5 & +/- 12	5 & +/- 12
		Nominal	VDC	5 & +/- 15	5 & +/- 15
Set Point accuracy	Ambient temperature : +25°C Ui nominal, 75% load	Maximum	%	+/- 2	+/- 2
Output power	Full temperature range Ui min. to max.	Maximum	W	10 & +/- 5	10 & +/- 5
Output current **	Full temperature range Ui min. to max.	Maximum	mA	2.000 & +/- 400	2.000 & +/- 400
3,3V & +/- 12V output		Maximum	mA	2.000 & +/- 300	2.000 & +/- 300
3,3V & +/- 15V output		Maximum	mA	2.000 & +/- 400	2.000 & +/- 400
5V & +/- 15V output		Maximum	mA	2.000 & +/- 300	2.000 & +/- 300
Ripple output voltage ***	Ui nominal Full load BW = 20MHz	Maximum	mVpp	40	40
3,3V and 5V output		Maximum	mVpp	50	50
12V output		Maximum	mVpp	60	60
Line regulation	Ui min. to max. Full load	Maximum	%	+/- 1	+/- 1
Load regulation	Ui nominal 25% to full load	Maximum	%	+/- 2	+/- 2
Cross load output regulation	Ui nominal + Vout nominal load - Vout from 25% to full load	Maximum	%	+/- 0,5	+/- 0,5
Efficiency	Ui nominal Full load	Typical	%	see on page 6	see on page 6
Maximum admissible Capacity load	Ui nominal Full load Per output	Maximum	µF	2.000	2.000
3,3V and 5V output				330	330
12V and 15V output					

Note * : For proper operation the MGDM-20 module requires to install a 22µF chemical or tantalum capacitor across output terminal.

Note ** : For 9-36V input range, the current is derated at 80% at 9V and increases linearly to full current at 12V.

Note*** : The ripple output voltage is the periodic AC component imposed on the output voltage, an aperiodic and random component (noise) has also to be considered. This noise can be reduced by adding an external capacitance (typically 10nF/rated voltage depending on isolation requirement) connected between the pin Gin and the pin Gout of the converter. This capacitance should be layed-out as close as possible from the converter.

3- Electrical Characteristics (continued)

Figure 1 : Typical efficiency versus load at nominal input

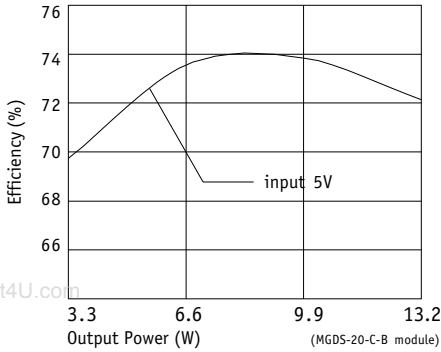

Figure 2 : Typical efficiency versus load at nominal input

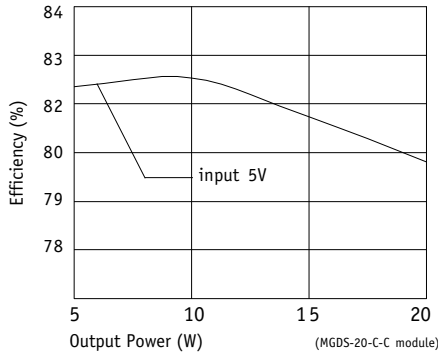

Figure 3 : Typical efficiency versus load at nominal input

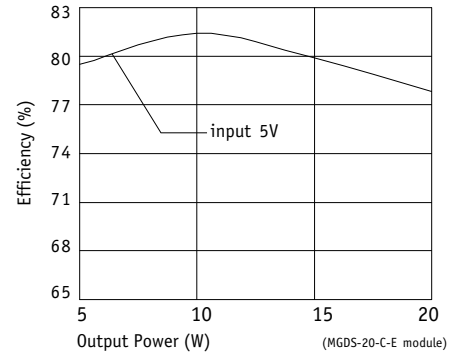

Figure 4 : Typical efficiency versus load at nominal input

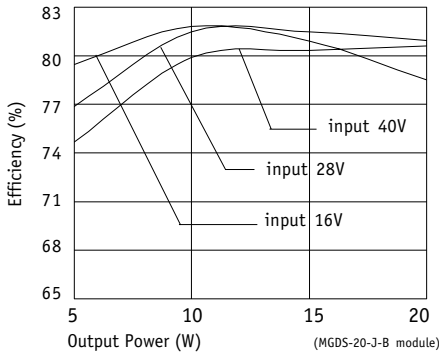

Figure 5 : Typical efficiency versus load at nominal input

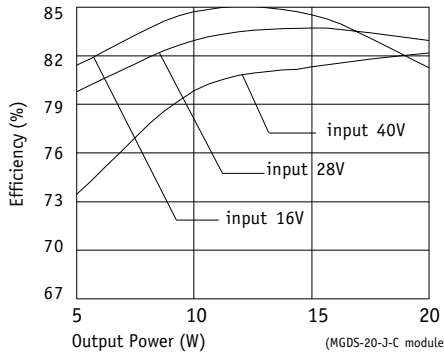

Figure 6 : Typical efficiency versus load at nominal input

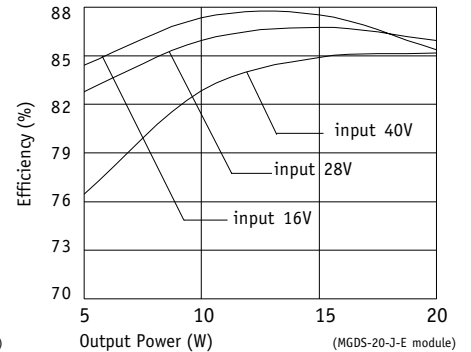

Figure 7 : Typical efficiency versus load at various input

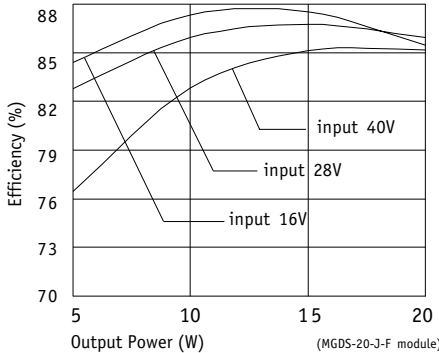

Figure 8 : Typical efficiency versus load at various input

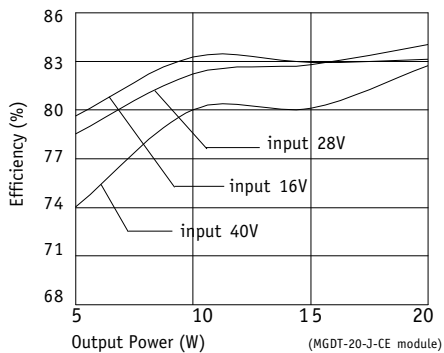

Figure 9 : Typical efficiency versus load at various input

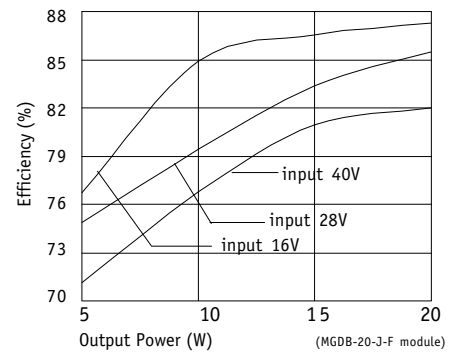

Figure 10 : Typical load regulation characteristics at nominal input

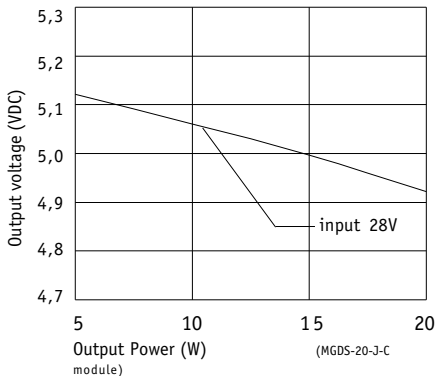

Figure 11 : Typical load regulation characteristics at nominal input

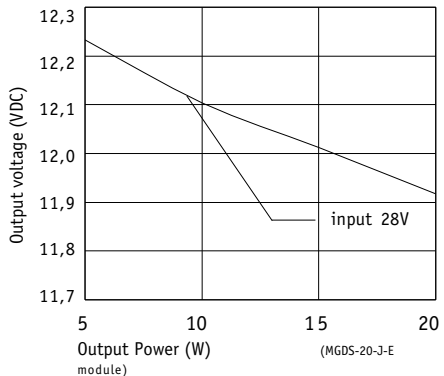
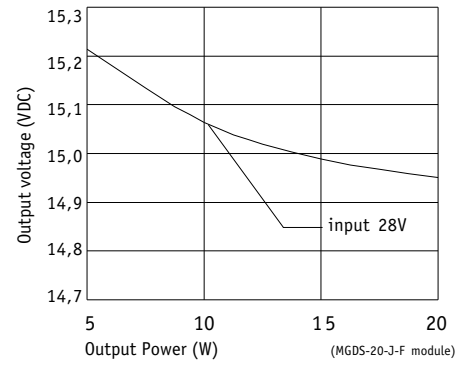

Figure 12 : Typical load regulation characteristics at nominal input



4

4- Functional Characteristics

Characteristics	Conditions	Limit or typical	Performances
Electric strength test voltage	Input to output	Minimum	1.500 VDC / 1 min
Isolation resistance	500 VDC	Minimum	100 Mohm
Inhibit function	Inhibit	/	See section 7.3
Short circuit protection	Short circuit	/	Permanent
Switching frequency	No load to full load	Nominal	480 KHz

5- Thermal and Reliability Characteristics

www.DataSheet4U.com

Characteristics	Conditions	Limit or typical	Performances
Operating ambient temperature range at full load	Ambient temperature *	Minimum Maximum	- 40°C + 85°C
Operating case temperature range at full load	Case temperature	Minimum Maximum	- 40°C + 105°C
Storage temperature range	Non functioning	Minimum Maximum	- 55°C + 125°C
Thermal resistance	Rth case to ambient in free air natural convection	Typical	7°C /W
Mean time between failure According to MIL - HDBK - 217F	Ground fixed (Gf) Airborne, Inhabited, Cargo (AIC)	Case at 40°C Case at 85°C Case at 40°C Case at 85°C	750.000 Hrs 320.000 Hrs 270.000 Hrs 105.000 Hrs

Note *: The upper temperature range depends on configuration, the user must assure a max. case temperature of + 105°C (See Application Notes : Ambient versus case temperature).

6- Environmental and Electromagnetic Interference Qualification

4

Characteristics	Conditions	Severity	Test procedure
Altitude	Altitude level C Climb up	40.000 ft, unit functioning 1.000 ft/min to 70.000 ft, unit functioning	MIL - STD - 810D Method 500.2
Humidity	Damp heat Duration	88 % H.R Cycle I : 240 Hrs	MIL - STD - 810D Method 507.2
Salt atmosphere	Duration	48 Hrs	MIL - STD - 810E Method 509.1
Temperature cycling	Number of cycles Temperature change Transfert time / Steady state time	200 -40°C / +85°C 40 min. / 20 min.	MIL - STD - 883C Method 1010
Vibration (Sinusoidal)	Number of cycles Frequency Amplitude/acceleration	10 cycles in each axis 10 to 60 Hz/60 to 2000 Hz 0.7 mm/10 g	MIL - STD - 810D Method 514.3
Shock (Half sinus)	Number of shocks Peak acceleration Duration	3 shocks in each axis 100 g 6 ms	MIL - STD - 810D Method 516.3
Bump (Half sinus)	Number of bumps Peak acceleration Duration	2000 Bumps in each axis 40 g 6 ms	MIL - STD - 810D Method 516.3
Conducted Emission	Module stand alone & common mode capacitance (10nF) With external filter KG9501 Module stand alone	CE01 CE03 CE07	MIL - STD - 461C
Conducted susceptibility	With external filter KG9501 With external filter KG9501	CS01, CS02 CS06 spike #2	MIL - STD - 461C
Radiated emission	Module stand alone & common mode capacitance (10nF)	RE01 RE02	MIL - STD - 461C
Radiated susceptibility	Module stand alone	RS01, RS03	MIL - STD - 461C

6- Environmental and Electromagnetic Interference Qualification (continued)

Electromagnetic interference requirements according to MIL-STD-461 C and MIL-STD-461 D can be easily achieved as indicated in the following table. Compliance to these requirements apply to J series or H series of DC/DC modules.

	MIL-STD-461 C	Module stand alone with common mode noise capacitance C_c	Module with external filter with common mode noise capacitance C_c
Conducted emission Low frequency 30Hz - 15KHz Narrowband 15KHz - 50 MHz Broadband 15KHz - 50 MHz	CE 01 CE 03 CE 03	CE 01 / /	CE 01 CE 03 CE 03
Conducted susceptibility Band 1.5 Hz - 50 KHz Band 50 KHz - 400 MHz	CS 01 CS 02	/ /	CS 01 CS 02
Radiated emission Band 30Hz - 15Hz Narrowband 14KHz - 1GHz Broadband 14KHz - 1GHz	RE 01 RE 02 RE 02	RE 01 RE 02 RE 02	RE 01 RE 02 RE 02
Radiated susceptibility Band 30 Hz - 50 KHz Band 14 KHz - 10GHz	RS 01 RS 03	RS 01 RS 03	RS 01 RS 03

www.DataSheet4U.com

6-1 Basic Configuration : Module Stand Alone with Common Mode Noise Capacitance

A basic configuration with module stand alone and common mode noise capacitance C_c connected between G_{in} and G_{out} will conduct to the results described in the previous table. This common mode noise capacitance C_c (10nF/rated voltage depending on isolation requirement) should be layed-out as close as possible from the DC/DC converter.

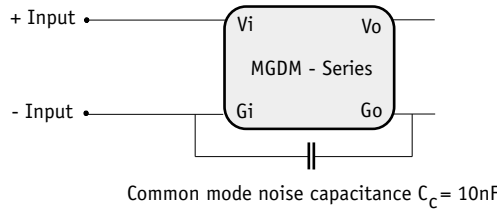

4

6-2 Configuration with Module and Front Filter KG9501

To meet MIL-STD-461 C requirements and in particular CE 03, Gaia Converter recommends the use of front filter KG9501 together with the common mode noise capacitance C_c (10nF/rated voltage depending on isolation requirement) connected between G_{in} and G_{out} . Please consult KG9501 datasheet for further details.

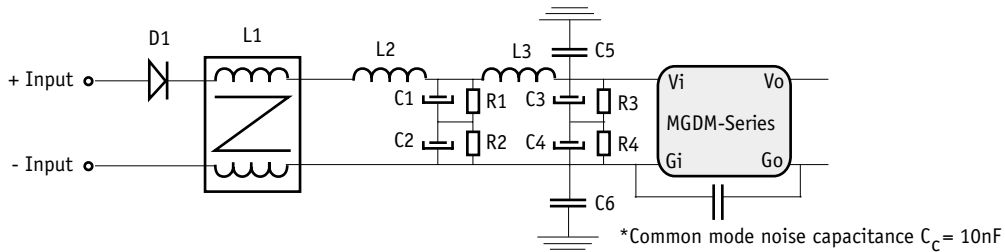

7- Application Notes

7-1 Short Circuit Protection

The short circuit protection device protects the modules against short circuits of any duration and restores the module to normal operation when the short circuit is removed.

7-2 Custom Output

Any of the bi output converters can be configured to produce an output of 10V (+/-5 output models), 24V (+/-12V output models), or 30V (+/-15V output models) by connecting the load across the output (+) and the output (-) with either output grounded, and leaving the common pin floating.

www.DataSheet4U.com

7-3 On/Off function

The control pin 4 (On/Off) can be used for applications requiring On/Off operation. By using an open collector command with a transistor Q referenced to the common terminal (Gi) :

- A logic pulled low (<math><0.2V@1mA</math>, referenced to Gi) on pin 4 disables the converter
- No connection or high impedance on pin 4 enables the converter.

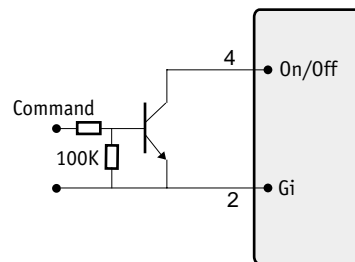

For further details please consult "Logic On/Off" Application Note.

By releasing the On/Off function, the converter will restart within the start-up time specifications given in table page 3.

7-4 Ambient versus Case Temperature

The MGDM-20 series operating **case** temperature at full load must not exceed 105°C. The maximum **ambient** temperature admissible for the DC/DC converter corresponding to the maximum operating case temperature of 105°C depends on the ambient airflow, the mounting/orientation, the cooling features and the power dissipated. Thermal calculation shows two areas of operation :

- a normal operation area in a free natural ambient convection (grey area in this following graph),
- an area with cooling features (air flow or heatsink) ensuring a maximum case temperature below the maximum operating case temperature of 105°C at full load (white area in the following graph).

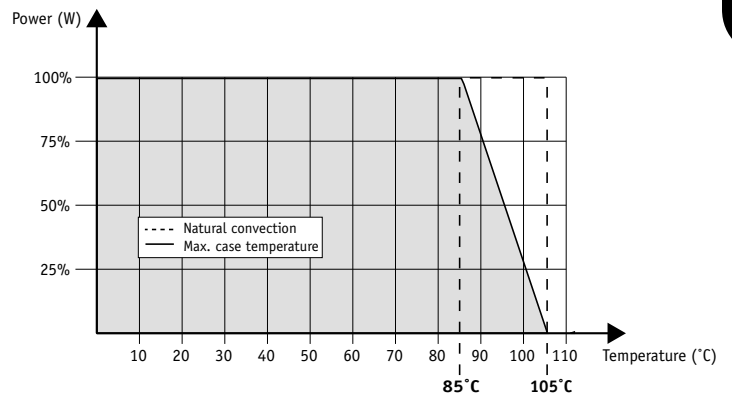

8- Dimensions

Dimension are given in mm (inches). Tolerance : +/- 0,2 mm (+/- 0.01 ") unless otherwise indicated.
Weight : 80 grams (2.8 Ozs) max.

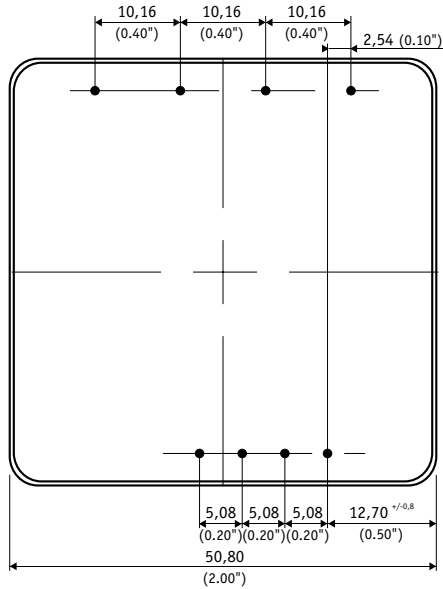

Metallic case black anodized coating solder plated pin

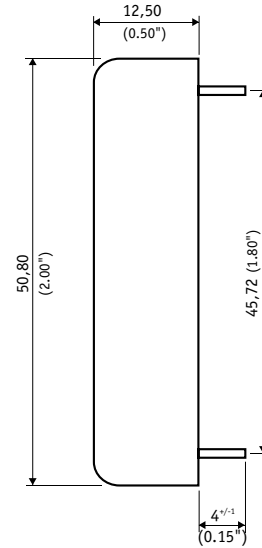

Pin dimensions : Ø 0,83 mm (0.033 ")

9- Product Marking

Upper face : Company logo, location of manufacturing, module reference.
Date code : year and week of manufacturing.

10- Connections

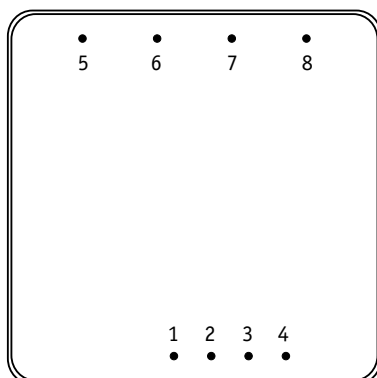

Bottom view

Pin	Single	Bi	Triple
1	+ Input (Vi)	+ Input (Vi)	+ Input (Vi)
2	- Input (Gi)	- Input (Gi)	- Input (Gi)
3	Case	Case	Case
4	On / Off	On / Off	On / Off
5	Non connected	Output + (+Vo)	Output 2+ (+V2)
6	Output (Vo)	Common (Go)	Output 1 (V1)
7	Common (Go)	Output - (-Vo)	Common (Go)
8	Non connected	Non connected	Output 2- (-V2)



For more detailed specifications and applications information, contact :

International Headquarters	North American Headquarters
Marketing and Sales department	GAIA Converter Canada, Inc
GAIA Converter - France	Address : 6611 Thimens
Address : B.P. 26 - 33186 LE HAILLAN - FRANCE	ST-LAURENT, QUEBEC - CANADA H4S 1W2
Tel. : + (33)-5-57-92-12-80	Tel. : (514)-333-3169
Fax : + (33)-5-57-92-12-89	Fax : (514)-333-4519

Represented by :