

FEATURES

- PRECISE TOLERANCE AND TEMPERATURE COEFFICIENT
- EIA STANDARD CASE SIZES (0201 ~ 2512)
- LOW NOISE, THIN FILM (NiCr) CONSTRUCTION
- REFLOW SOLDERABLE (Pb FREE TERMINATION FINISH)

RoHS Compliant
includes all homogeneous materials

*See Part Number System for Details



Type	EIA Size	Power Rating at 70°C	Max.*1 Working Voltage	Max.*2 Overload Voltage	Resistance Tolerance (Code)	Temperature Coefficient (ppm/°C)	Resistance Range (Ω)	Resistance Values
NTR02	0201	1/20 (0.050)W	15V	30V	±0.5% (D)	±25	33 ~ 22KΩ	E - 24
					±1.0% (F)	±100	10 ~ 30Ω	
NTR04	0402	1/16 (0.063)W	25V	50V	±0.01% (T), ±0.05% (A), ±0.1% (B), ±0.25% (C), ±0.5% (D)	±5	49.9 ~ 3KΩ	E-24 & E-96
					±0.01% (T), ±0.05% (A), ±0.1% (B), ±0.25% (C), ±0.5% (D), ±1% (F)	±10, ±15	49.9 ~ 12KΩ	
					±0.01% (T), ±0.05% (A), ±0.1% (B), ±0.25% (C), ±0.5% (D), ±1% (F)	±25, ±50	10 ~ 205KΩ	
NTR06	0603	1/16 (0.063)W	50V	100V	±0.01% (T), ±0.05% (A)	±5	24.9 ~ 15KΩ	E-24 & E-96
					±0.1% (B), ±0.25% (C), ±0.5% (D)	±10, ±15	24.9 ~ 100KΩ	
					±0.01% (T)	±10, ±15	4.7 ~ 332KΩ	
					±0.05% (A)	±25, ±50	24.9 ~ 100KΩ	
					±0.1% (B), ±0.25% (C), ±0.5% (D), ±1% (F)	±25, ±50	4.7 ~ 150KΩ	
NTR10	0805	1/10 (0.10) W	100V	200V	±0.01% (T), ±0.05% (A)	±5	2.0 ~ 4.53Ω	E-24 & E-96
					±0.1% (B), ±0.25% (C), ±0.5% (D)	±10, ±15	24.9 ~ 30KΩ	
					±0.01% (T)	±10, ±15	24.9 ~ 200KΩ	
					±0.05% (A)	±25, ±50	4.7 ~ 499KΩ	
					±0.1% (B), ±0.25% (C), ±0.5% (D), ±1% (F)	±25, ±50	4.7 ~ 2MΩ	
NTR12	1206	1/8 (0.125) W	150V	300V	±0.01% (T), ±0.05% (A), ±0.1% (B)	±5	1 ~ 4.53Ω	E-24 & E-96
					±0.1% (B), ±0.25% (C), ±0.5% (D)	±10, ±15	24.9 ~ 499KΩ	
					±0.01% (T)	±10, ±15	24.9 ~ 499KΩ	
					±0.05% (A)	±25, ±50	4.7 ~ 1MΩ	
					±0.1% (B), ±0.25% (C), ±0.5% (D), ±1% (F)	±25, ±50	4.7 ~ 2.49MΩ	
NTR25	2010	1/4 (0.25) W	150V	300V	±0.01% (T), ±0.05% (A), ±0.1% (B), ±0.25% (C), ±0.5% (D)	±5	1.0 ~ 4.53Ω	E-24 & E-96
					±0.01% (T)	±10, ±15	24.9 ~ 100KΩ	
					±0.05% (A)	±10, ±15	24.9 ~ 499KΩ	
					±0.1% (B), ±0.25% (C), ±0.5% (D), ±1% (F)	±25, ±50	4.7 ~ 1MΩ	
					±0.25% (C), ±0.5% (D), ±1% (F)	±25, ±50	4.7 ~ 3MΩ	
NTR50	2512	1/2 (0.50) W	150V	300V	±0.01% (T), ±0.05% (A), ±0.1% (B), ±0.25% (C), ±0.5% (D)	±5	24.9 ~ 100KΩ	E-24 & E-96
					±0.01% (T)	±10, ±15	24.9 ~ 499KΩ	
					±0.05% (A)	±10, ±15	4.7 ~ 1MΩ	
					±0.1% (B), ±0.25% (C), ±0.5% (D), ±1% (F)	±25, ±50	24.9 ~ 499KΩ	
					±0.25% (C), ±0.5% (D), ±1% (F)	±25, ±50	4.7 ~ 3MΩ	

Note *1 - Maximum allowable continuous Working Voltage for all resistors is the lower of the two values:
 "Maximum Working Voltage" as specified above
 or

$$\sqrt{\text{Power rating (Watts)} \times \text{Resistance (Ohms)}}$$

Note *2 - Maximum Overload Voltage for all resistors is the lower of the two values:
 "Maximum Overload Voltage" as specified above
 or

$$2 \times \sqrt{\text{Power rating (Watts)} \times \text{Resistance (Ohms)}}$$

TYPICAL NOISE CHARACTERISTICS

Resistance Value (Ω)	Case Size		
	0603	0805	1206
1 ~ 9	-95dB	-95dB	-95dB
10 ~ 49	-85dB	-85dB	-85dB
50 ~ 99	-85dB	-85dB	-85dB
100 ~ 4.99K	-100dB	-100dB	-105dB
5K ~ 19.9K	-100dB	-100dB	-100dB
20K ~ 1M	-90dB	-100dB	-100dB

Power Derating Curve: For operation above 70°C, power rating must be derated according to the following chart:

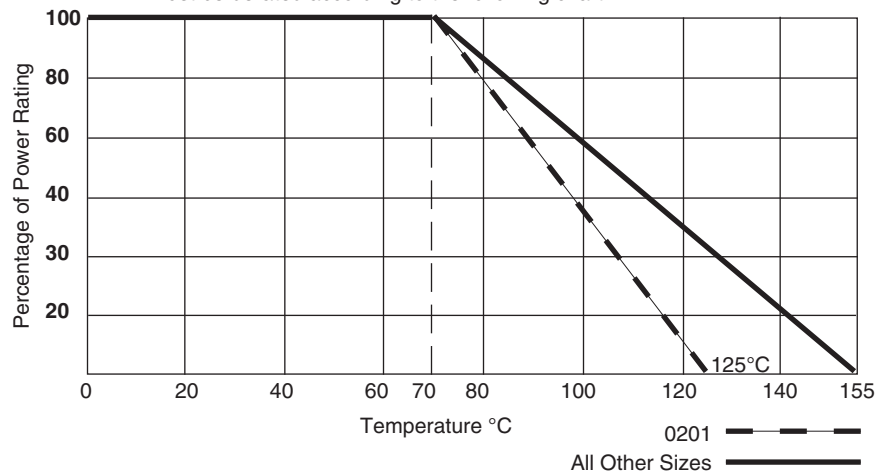

ENVIRONMENTAL CHARACTERISTICS

Item	Specification		Test Method*
	Tol. ≤ 0.05%	Tol. > 0.05%	
Temperature Coefficient of Resistance	As specified		MIL-STD-202, Method 304 +25/-55/+25/+125/-25
Short Time Overload	ΔR ±0.05%	ΔR ±0.5%	JIS-C-5202-5.5 RCWV x 2.5 or Max Overloading Voltage for 5 Seconds
Dielectric Withstanding Voltage (N/A 0201 Size)	As specified		MIL-STD-202F Method 301 Apply Max. Overload Voltage for 1 minute
Insulation Resistance	>1000MΩ		MIL-STD-202F Method 302 Apply 100Vdc for 1 minute
Thermal Shock (N/A 0201 Size)	ΔR ±0.05%	ΔR ±0.25%	MIL-STD-202F Method 107G -55°C ~ +150°C, 100 cycles
Load Life	ΔR ±0.05%	ΔR ±0.2%	MIL-STD-202F Method 108A RCWV +70°C, 1.5 hours ON, 0.5 hours OFF Total time 1,000 ~ 1,048 hours
	>7KΩ ΔR ±0.5%		
Humidity (Steady State)	ΔR ±0.05%	ΔR ±0.3%	MIL-STD-202F Method 103B +40°C, 90% ~ 95% RH, RCWV 1.5 hours ON, 0.5 hours OFF Total time 1,000 ~ 1,048 hours
Resistance to Dry Heat (N/A 0201 Size)	ΔR ±0.05%	ΔR ±0.2%	JIS-C5202-7.2 96 hours @ +155°C without load
Low Temperature Operation (N/A 0201 Size)	ΔR ±0.05%	ΔR ±0.2%	JIS-C-502-7.1 1 hour @ -65°C followed by 45 minutes of RCWV
Bending Strength	ΔR ±0.05%	ΔR ±0.2%	JIS-C-5202-6.1.4 Bending Amplitude 3mm for 10 seconds
Solderability	95% Minimum Coverage		MIL-STD-202F Method 208H 245°C ±5°C, 5 ±0.5 seconds
Resistance to Soldering Heat	ΔR ±0.05%	ΔR ±0.2%	MIL-STD-202F Method 210E 260°C ±5°C for 10 ±1 seconds

*0201 testing per IEC 60115 - 1

STANDARD E-24, E-96 VALUES AND 0603 RESISTANCE CODES

E-24	E-96							
Value	Value	Code	Value	Code	Value	Code	Value	Code
100	100	01	102	02	105	03	107	04
110	110	05	113	06	115	07	118	08
120	121	09	124	10	127	11	130	12
130	133	13	137	14	140	15	143	16
150	147	17	150	18	154	19	158	20
160	162	21	165	22	169	23	174	24
180	178	25	182	26	187	27	191	28
200	196	29	200	30	205	31	210	32
220	215	33	221	34	226	35	232	36
240	237	37	243	38	249	39	255	40
270	261	41	267	42	274	43	280	44
300	287	45	294	46	301	47	309	48
330	316	49	324	50	332	51	340	52
360	348	53	357	54	365	55	374	56
390	383	57	392	58	402	59	412	60
430	422	61	432	62	442	63	453	64
470	464	65	475	66	487	67	499	68
510	511	69	523	70	536	71	549	72
560	562	73	576	74	590	75	604	76
620	619	77	634	78	649	79	665	80
680	681	81	698	82	715	83	732	84
750	750	85	768	86	787	87	806	88
820	825	89	845	90	866	91	887	92
910	909	93	931	94	953	95	976	96

MULTIPLIER CODE

Code	A	B, b	C	D, d	E	F	G	H	X	Y	Z
Multiplier	10 ⁰	10 ¹	10 ²	10 ³	10 ⁴	10 ⁵	10 ⁶	10 ⁷	10 ⁻¹	10 ⁻²	10 ⁻³

1. No marking on 0402 case size.

2. Marking for 0603 case size:

E-24 values and E-96 Series - ± 1% (F), ± 0.5% (D), ± 0.25% (C), ± 0.1% (B) tolerances

CODING FORMULA

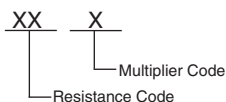

Example: $10.2k\Omega = \frac{102}{02} \times \frac{10^2}{C} \Omega = 02C$
 $33.2 \Omega = \frac{332}{51} \times \frac{10^{-1}}{X} = 51X$

MARKING EXAMPLES

10Ω = 01X
 7.5k Ω = 85B
 150k Ω = 18D
 1 MegΩ = 01E

3. Marking for 0805, 1206, 2010 and 2512 case sizes:

E-24 and E-96 series - ±1%(F), ±0.5%(D), ±0.25%(C), ±0.1%(B) tolerances

4 DIGIT MARKING SYSTEM - First 3 digits are the significant figures, the 4th digit is the multiplier. "R"= decimal point.

Examples: 0R10 = 0.10 ohms, 1R00 = 1.0 ohms, 22R1=22.1 ohms, 3320= 332 ohms, 4751=4.75K ohms, 1132=11.3K ohms, 6493=649K ohms

PART NUMBER SYSTEM

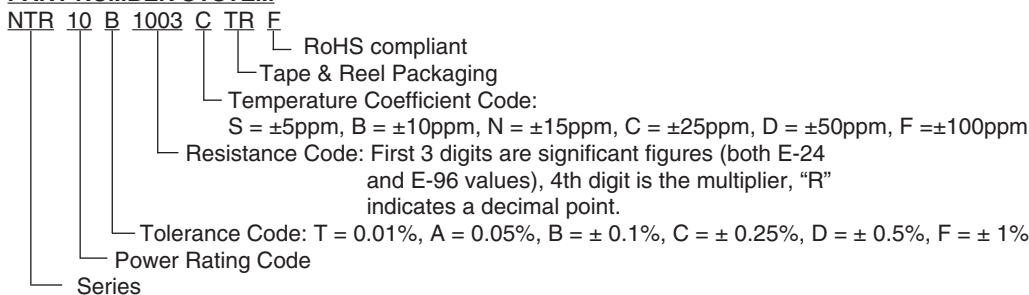

DIMENSIONS (mm)

Type	Power Rating	EIA Size	L	W	H	T	t
NTR02	1/20W	0201	0.6 ± 0.05	0.3 ± 0.05	0.23 ± 0.03	0.12 ± 0.05	0.12 ± 0.05
NTR04	1/16W	0402	1.0 ± 0.05	0.5 ± 0.05	0.30 ± 0.05	0.2 ± 0.10	0.20 ± 0.10
NTR06	1/16W	0603	1.55 ± 0.10	0.8 ± 0.10	0.45 ± 0.10	0.3 ± 0.20	0.30 ± 0.20
NTR10	1/10W	0805	2.0 ± 0.15	1.25 ± 0.15	0.55 ± 0.10	0.3 ± 0.20	0.40 ± 0.25
NTR12	1/8W	1206	3.05 ± 0.10	1.5 ± 0.10	0.55 ± 0.10	0.42 ± 0.20	0.35 ± 0.25
NTR25	1/4W	2010	4.9 ± 0.15	2.4 ± 0.15	0.55 ± 0.10	0.6 ± 0.30	0.50 ± 0.25
NTR50	1/2W	2512	6.3 ± 0.15	3.1 ± 0.15	0.55 ± 0.10	0.6 ± 0.30	0.50 ± 0.25

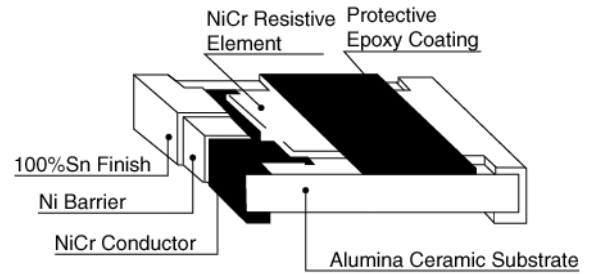
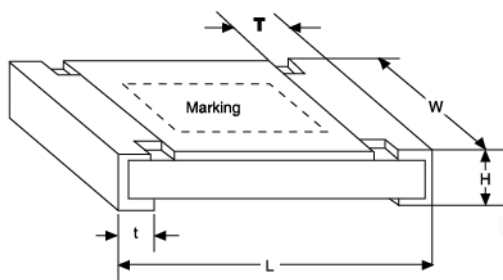

TAPING SPECIFICATIONS

(1) Availability

Type	Power Rating	EIA Size	Carrier Tape			Qty per Reel (pcs)
			Fig.	Material	Width (mm)	
NTR02	1/20W	0201	A	Paper	8	20,000
NTR04	1/16W	0402	A			10,000
NTR06	1/16W	0603	A			5,000
NTR10	1/10W	0805	A			
NTR12	1/8W	1206	A			
NTR25	1/4W	2010	B	Plastic	12	4,000
NTR50	1/2W	2512	B			

(2) PAPER TAPE DIMENSIONS (mm)

FIG. A

Type	EIA Size	A	B	D	E	F	P ₀	P ₁	P ₂	W	T
NTR02	0201	0.38 ± 0.03	0.68 ± 0.03	1.55 ± 0.05	1.75 ± 0.10	3.50 ± 0.05	4.0 ± 0.10	2.0 ± 0.05	2.0 ± 0.05	8.0 ± 0.1	0.31 ± 0.02
NTR04	0402	0.67 ± 0.03	1.15 ± 0.03								0.40 ± 0.03
NTR06	0603	1.10 ± 0.05	1.90 ± 0.05					0.60 ± 0.03			
NTR10	0805	1.60 ± 0.05	2.37 ± 0.05					0.75 ± 0.05			
NTR12	1206	2.00 ± 0.05	3.55 ± 0.05								

FIG. A

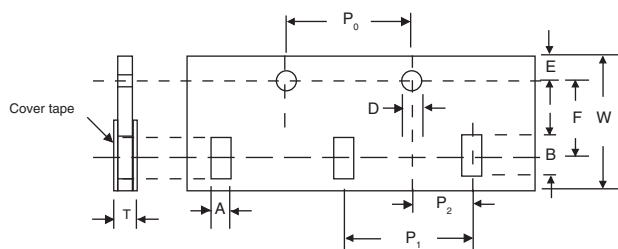

(2) PLASTIC EMBOSSED TAPE DIMENSIONS (mm)

FIG. B

Type	EIA Size	A	B	D	E	F	P ₀	P ₁	P ₂	W	T
NTR25	2010	2.85 ± 0.10	5.45 ± 0.10	1.50 ± 0.10	1.75 ± 0.10	5.50 ± 0.05	4.0 ± 0.10	4.0 ± 0.05	2.0 ± 0.05	12.0 ± 0.1	0.85 ± 0.10
NTR50	2512	3.40 ± 0.10	6.65 ± 0.10								

FIG. B

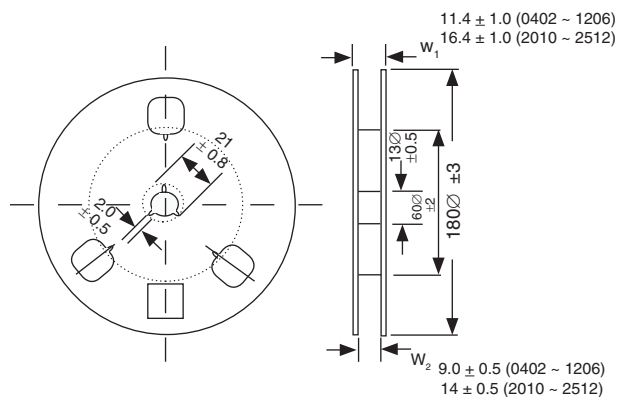
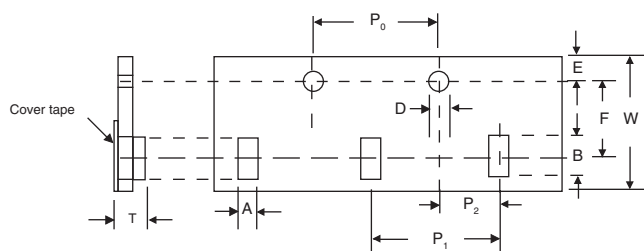

LAND PATTERN DIMENSIONS (mm)

Type	EIA Size	A	B	C
NTR02	0201			
NTR04	0402	0.50	0.50	0.60 ± 0.2
NTR06	0603	0.80	0.70	0.90 ± 0.2
NTR10	0805	1.00	1.00	1.35 ± 0.2
NTR12	1206	2.00	1.15	1.70 ± 0.2
NTR25	2010	3.60	1.40	2.40 ± 0.2
NTR50	2512	4.90	1.60	3.00 ± 0.2

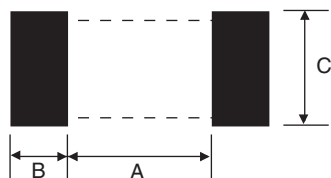

PEAK REFLOW SOLDERING CONDITIONS

