

# NTD20P06L

## Power MOSFET

-60 V, -15.5 A, Single P-Channel, DPAK

### Features

- Withstands High Energy in Avalanche and Commutation Modes
- Low Gate Charge for Fast Switching
- Pb-Free Packages are Available

### Applications

- Bridge Circuits
- Power Supplies, Power Motor Controls
- DC-DC Conversion

### MAXIMUM RATINGS (T<sub>J</sub> = 25°C unless otherwise noted)

Parameter	Symbol	Value	Unit	
Drain-to-Source Voltage	V <sub>DSS</sub>	-60	V	
Gate-to-Source Voltage	Continuous	V <sub>GS</sub>	± 20 V	
	Non-Repetitive	t <sub>p</sub> ≤ 10 ms	V <sub>GSM</sub>	± 30
Continuous Drain Current (Note 1)	Steady State	T <sub>A</sub> = 25°C	I <sub>D</sub>	-15.5 A
Power Dissipation (Note 1)	Steady State	T <sub>A</sub> = 25°C	P <sub>D</sub>	65 W
Pulsed Drain Current	t <sub>p</sub> = 10 μs	I <sub>DM</sub>	± 50 A	
Operating Junction and Storage Temperature	T <sub>J</sub> , T <sub>STG</sub>	-55 to 175	°C	
Single Pulse Drain-to-Source Avalanche Energy (V <sub>DD</sub> = 25 V, V <sub>GS</sub> = 5 V, I <sub>PK</sub> = 15 A, L = 2.7 mH, R <sub>G</sub> = 25 Ω)	E <sub>AS</sub>	304	mJ	
Lead Temperature for Soldering Purposes (1/8" from case for 10 s)	T <sub>L</sub>	260	°C	

### THERMAL RESISTANCE RATINGS

Parameter	Symbol	Max	Unit
Junction-to-Case (Drain)	R <sub>θJC</sub>	2.3	°C/W
Junction-to-Ambient - Steady State (Note 1)	R <sub>θJA</sub>	80	
Junction-to-Ambient - Steady State (Note 2)	R <sub>θJA</sub>	110	

Maximum ratings are those values beyond which device damage can occur. Maximum ratings applied to the device are individual stress limit values (not normal operating conditions) and are not valid simultaneously. If these limits are exceeded, device functional operation is not implied, damage may occur and reliability may be affected.

1. Surface-mounted on FR4 board using 1 in sq. pad size (Cu area = 1.127 in sq. [1 oz] including traces)
2. Surface-mounted on FR4 board using the minimum recommended pad size (Cu area = 0.412 in sq.)



ON Semiconductor®

<http://onsemi.com>

V <sub>(BR)DSS</sub>	R <sub>DS(on)</sub> TYP	I <sub>D</sub> MAX (Note 1)
-60 V	130 mΩ @ -5.0 V	-15.5 A

### P-Channel

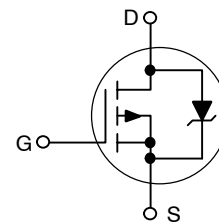

### MARKING DIAGRAMS

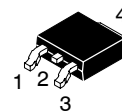

DPAK  
CASE 369C  
Style 2

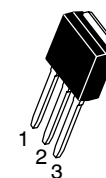

DPAK  
CASE 369D  
Style 2

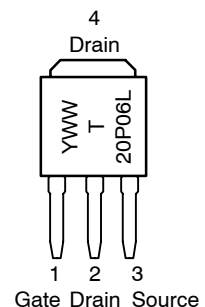
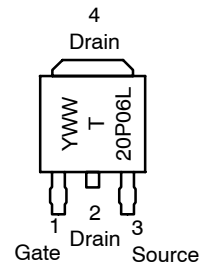

20P06L Device Code  
Y = Year  
WW = Work Week

### ORDERING INFORMATION

See detailed ordering and shipping information in the package dimensions section on page 6 of this data sheet.

# NTD20P06L

## ELECTRICAL CHARACTERISTICS ( $T_J = 25^\circ\text{C}$ unless otherwise noted)

Parameter	Symbol	Test Condition	Min	Typ	Max	Units
<b>OFF CHARACTERISTICS</b>						
Drain-to-Source Breakdown Voltage	$V_{(BR)DSS}$	$V_{GS} = 0\text{ V}, I_D = -250\ \mu\text{A}$	-60	-74		V
Drain-to-Source Breakdown Voltage Temperature Coefficient	$V_{(BR)DSS}/T_J$			-64		mV/°C
Zero Gate Voltage Drain Current	$I_{DSS}$	$V_{GS} = 0\text{ V}, V_{DS} = -60\text{ V}$	$T_J = 25^\circ\text{C}$		-1.0	$\mu\text{A}$
			$T_J = 150^\circ\text{C}$		-10	
Gate-to-Source Leakage Current	$I_{GSS}$	$V_{DS} = 0\text{ V}, V_{GS} = \pm 20\text{ V}$			$\pm 100$	nA

## ON CHARACTERISTICS (Note 3)

Gate Threshold Voltage	$V_{GS(TH)}$	$V_{GS} = V_{DS}, I_D = -250\ \mu\text{A}$	-1.0	-1.5	-2.0	V
Gate Threshold Temperature Coefficient	$V_{GS(TH)}/T_J$			3.1		mV/°C
Drain-to-Source On Resistance	$R_{DS(on)}$	$V_{GS} = -5.0\text{ V}, I_D = -7.5\text{ A}$		0.130	0.150	$\Omega$
		$V_{GS} = -5.0\text{ V}, I_D = -15\text{ A}$		0.143		
Forward Transconductance	$g_{FS}$	$V_{DS} = -10\text{ V}, I_D = -7.5\text{ A}$		11		S
Drain-to-Source On-Voltage	$V_{DS(on)}$	$V_{GS} = -5.0\text{ V}, I_D = -7.5\text{ A}$	$T_J = 25^\circ\text{C}$		-1.2	V
			$T_J = 150^\circ\text{C}$		-1.9	

## CHARGES AND CAPACITANCES

Input Capacitance	$C_{ISS}$	$V_{GS} = 0\text{ V}, f = 1\text{ MHz}, V_{DS} = -25\text{ V}$		740	1190	pF
Output Capacitance	$C_{OSS}$			207	300	
Reverse Transfer Capacitance	$C_{RSS}$			66	120	
Total Gate Charge	$Q_{G(TOT)}$	$V_{GS} = -5.0\text{ V}, V_{DS} = -48\text{ V}, I_D = -18\text{ A}$		15	26	nC
Gate-to-Source Charge	$Q_{GS}$			4.0		
Gate-to-Drain Charge	$Q_{GD}$			7.0		

## SWITCHING CHARACTERISTICS (Note 4)

Turn-On Delay Time	$t_{d(ON)}$	$V_{GS} = -5.0\text{ V}, V_{DD} = -30\text{ V}, I_D = -15\text{ A}, R_G = 9.1\ \Omega$		11	20	ns
Rise Time	$t_r$			90	180	
Turn-Off Delay Time	$t_{d(OFF)}$			28	50	
Fall Time	$t_f$			70	135	

## DRAIN-SOURCE DIODE CHARACTERISTICS

Forward Diode Voltage	$V_{SD}$	$V_{GS} = 0\text{ V}, I_S = -15\text{ A}$	$T_J = 25^\circ\text{C}$	1.5	2.5	V
			$T_J = 150^\circ\text{C}$	1.3		
Reverse Recovery Time	$t_{RR}$	$V_{GS} = 0\text{ V}, dI_S/dt = 100\text{ A}/\mu\text{s}, I_S = -12\text{ A}$		60		ns
Charge Time	$t_a$			39		
Discharge Time	$t_b$			21		
Reverse Recovery Charge	$Q_{RR}$			0.13		

3. Pulse Test: pulse width  $\leq 300\ \mu\text{s}$ , duty cycle  $\leq 2\%$

4. Switching characteristics are independent of operating junction temperatures

# NTD20P06L

## TYPICAL PERFORMANCE CURVES

( $T_J = 25^\circ\text{C}$  unless otherwise noted)

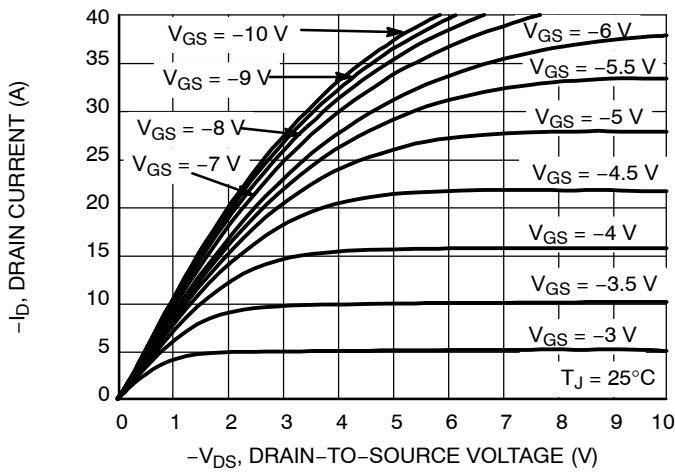

Figure 1. On-Region Characteristics

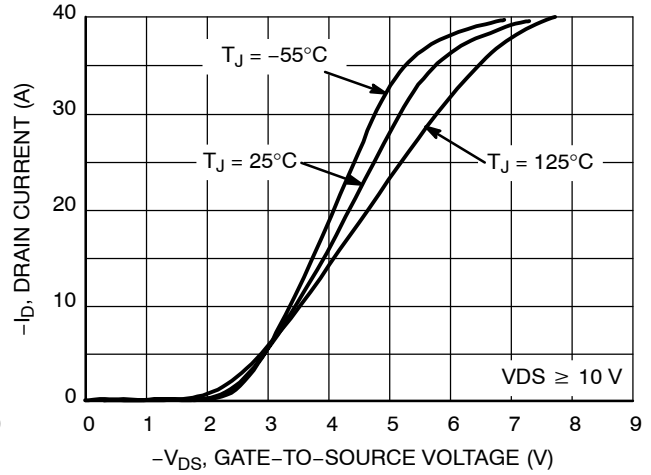

Figure 2. Transfer Characteristics

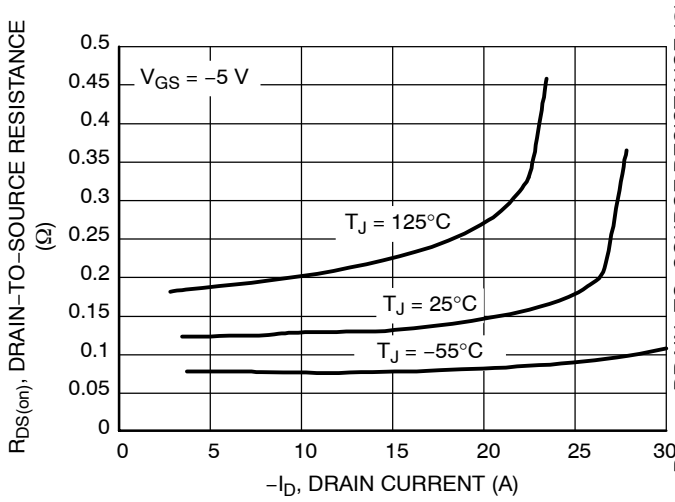

Figure 3. On-Resistance versus Drain Current and Temperature

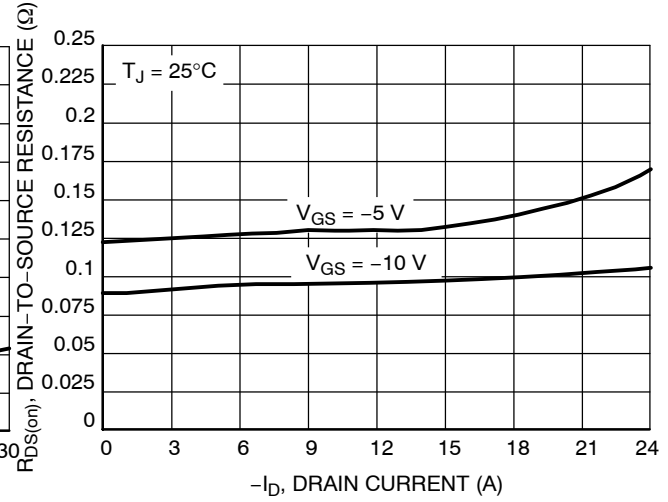

Figure 4. On-Resistance versus Drain Current and Gate Voltage

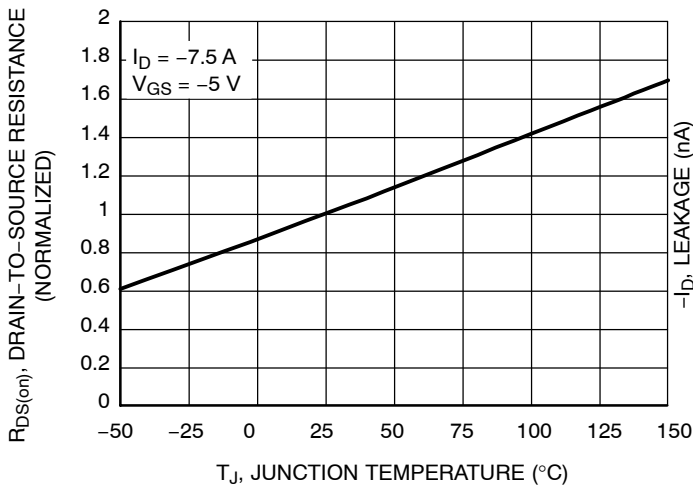

Figure 5. On-Resistance Variation with Temperature

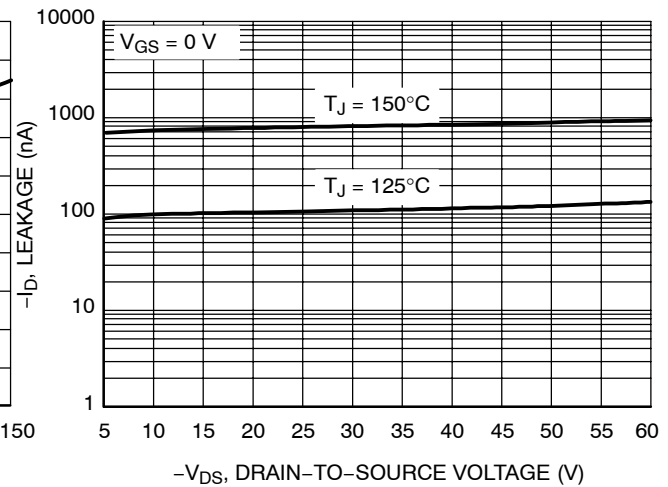

Figure 6. Drain-to-Source Leakage Current versus Voltage

# NTD20P06L

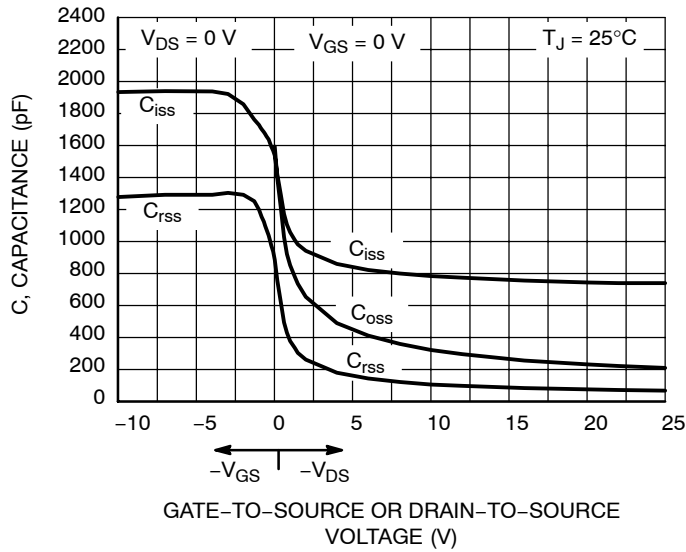

Figure 7. Capacitance Variation

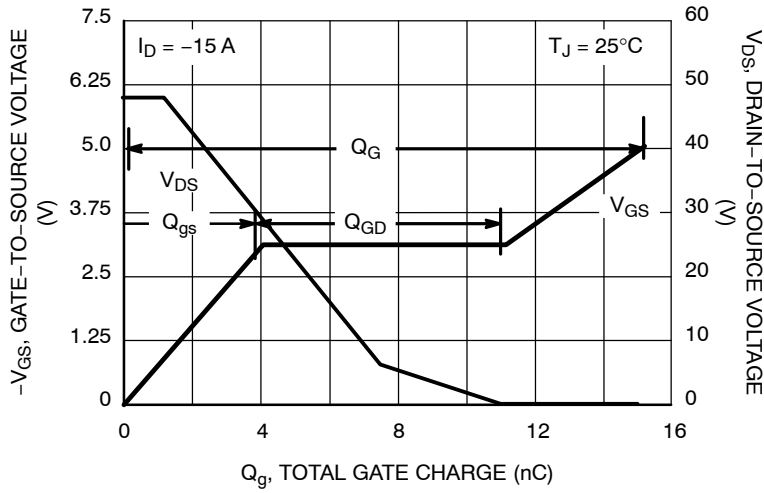

Figure 8. Gate-to-Source and Drain-to-Source Voltage versus Total Charge

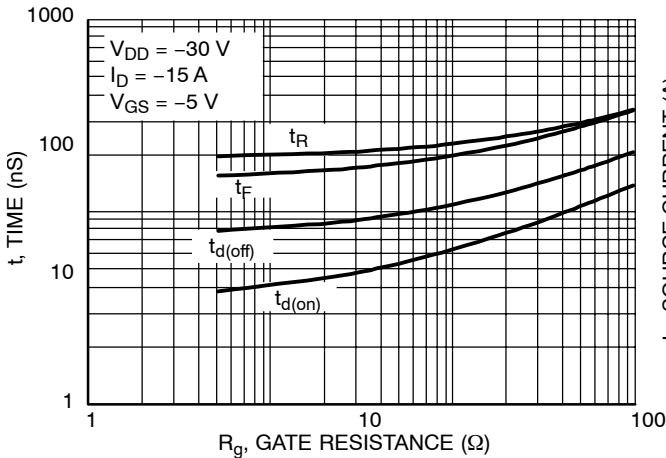

Figure 9. Resistive Switching Time Variation versus Gate Resistance

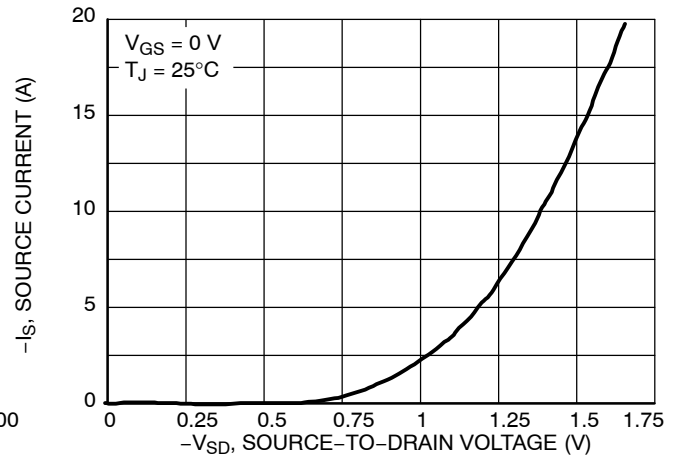
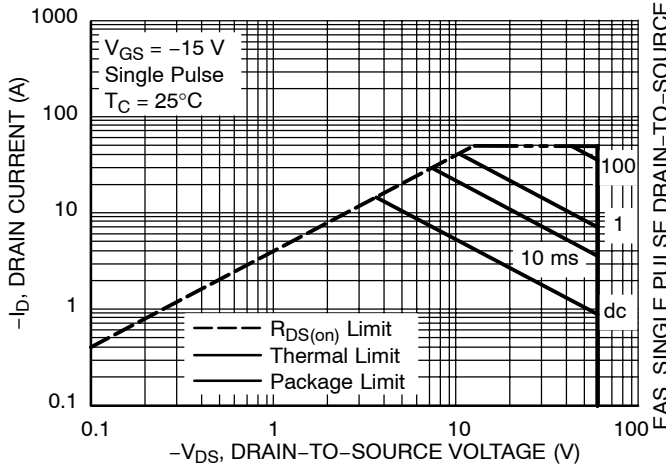
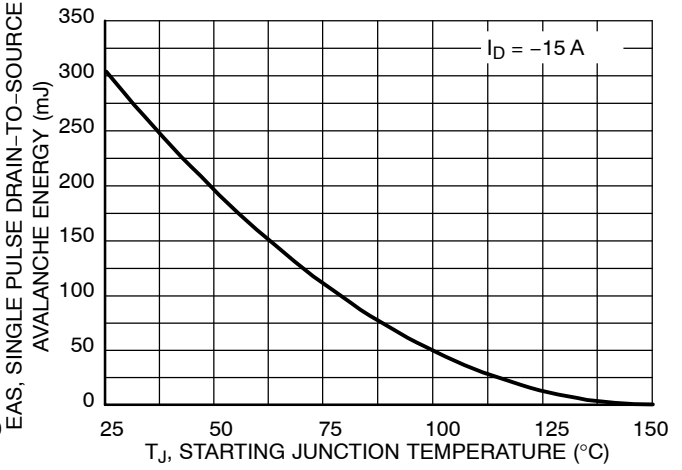

Figure 10. Diode Forward Voltage versus Current

# NTD20P06L



**Figure 11. Maximum Rated Forward Biased Safe Operating Area**



**Figure 12. Maximum Avalanche Energy versus Starting Junction Temperature**

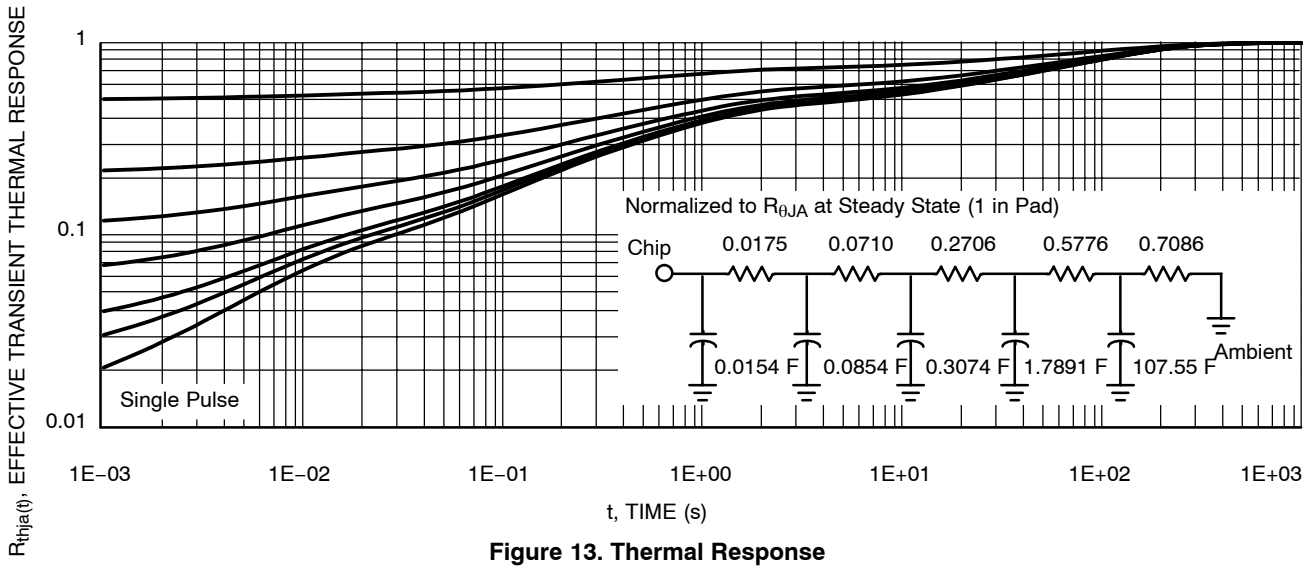

**Figure 13. Thermal Response**

# NTD20P06L

## ORDERING INFORMATION

Device	Package	Shipping†
NTD20P06L-1	DPAK	75 Units / Rail
NTD20P06L		75 Units / Rail
NTD20P06LT4		2500 /Tape & Reel
NTD20P06L-1G	DPAK (Pb-Free)	75 Units / Rail
NTD20P06LG		75 Units / Rail
NTD20P06LT4G		2500 / Tape & Reel

†For information on tape and reel specifications, including part orientation and tape sizes, please refer to our Tape and Reel Packaging Specifications Brochure, BRD8011/D.

# NTD20P06L

## PACKAGE DIMENSIONS

DPAK-3  
CASE 369C-01  
ISSUE O

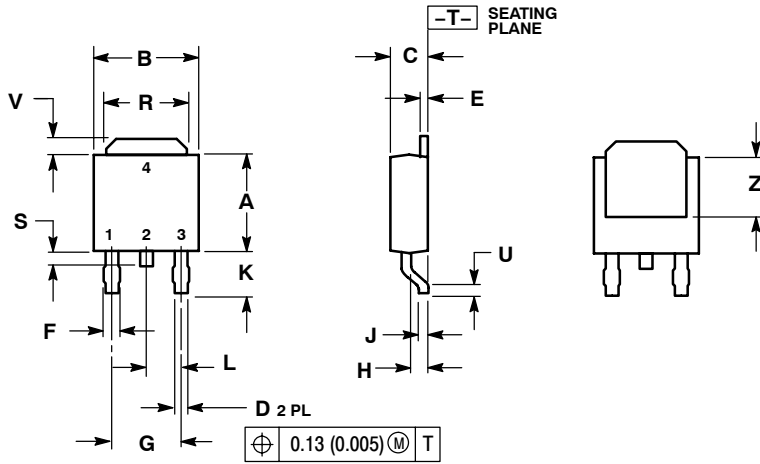

- NOTES:  
1. DIMENSIONING AND TOLERANCING PER ANSI Y14.5M, 1982.  
2. CONTROLLING DIMENSION: INCH.

DIM	INCHES		MILLIMETERS	
	MIN	MAX	MIN	MAX
A	0.235	0.245	5.97	6.22
B	0.250	0.265	6.35	6.73
C	0.086	0.094	2.19	2.38
D	0.027	0.035	0.69	0.88
E	0.018	0.023	0.46	0.58
F	0.037	0.045	0.94	1.14
G	0.180 BSC		4.58 BSC	
H	0.034	0.040	0.87	1.01
J	0.018	0.023	0.46	0.58
K	0.102	0.114	2.60	2.89
L	0.090 BSC		2.29 BSC	
R	0.180	0.215	4.57	5.45
S	0.025	0.040	0.63	1.01
U	0.020	---	0.51	---
V	0.035	0.050	0.89	1.27
Z	0.155	---	3.93	---

- STYLE 2:  
PIN 1. GATE  
2. DRAIN  
3. SOURCE  
4. DRAIN

### SOLDERING FOOTPRINT\*

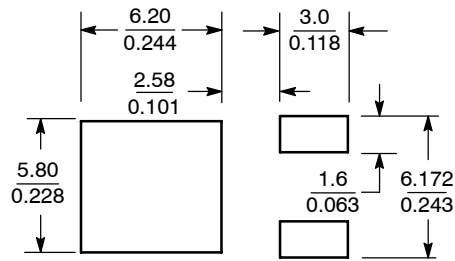

\*For additional information on our Pb-Free strategy and soldering details, please download the ON Semiconductor Soldering and Mounting Techniques Reference Manual, SOLDERRM/D.

# NTD20P06L

## PACKAGE DIMENSIONS

**DPAK-3**  
CASE 369D-01  
ISSUE B

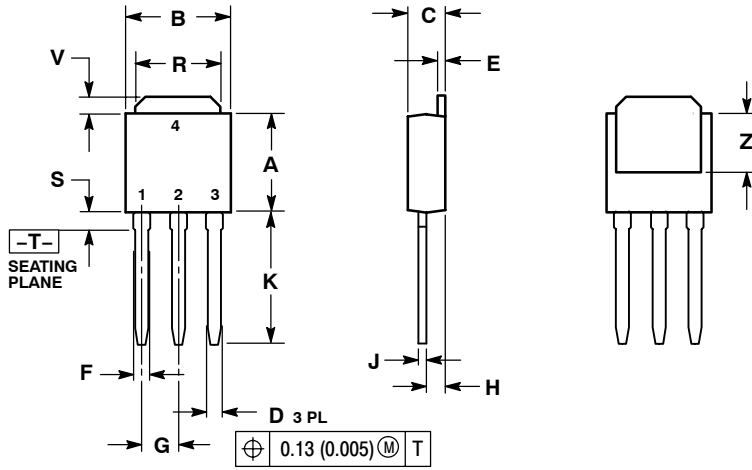

**NOTES:**

1. DIMENSIONING AND TOLERANCING PER ANSI Y14.5M, 1982.
2. CONTROLLING DIMENSION: INCH.

DIM	INCHES		MILLIMETERS	
	MIN	MAX	MIN	MAX
A	0.235	0.245	5.97	6.35
B	0.250	0.265	6.35	6.73
C	0.086	0.094	2.19	2.38
D	0.027	0.035	0.69	0.88
E	0.018	0.023	0.46	0.58
F	0.037	0.045	0.94	1.14
G	0.090	BSC	2.29	BSC
H	0.034	0.040	0.87	1.01
J	0.018	0.023	0.46	0.58
K	0.350	0.380	8.89	9.65
R	0.180	0.215	4.45	5.45
S	0.025	0.040	0.63	1.01
V	0.035	0.050	0.89	1.27
Z	0.155	---	3.93	---

**STYLE 2:**

- PIN 1. GATE  
2. DRAIN  
3. SOURCE  
4. DRAIN

ON Semiconductor and are registered trademarks of Semiconductor Components Industries, LLC (SCILLC). SCILLC reserves the right to make changes without further notice to any products herein. SCILLC makes no warranty, representation or guarantee regarding the suitability of its products for any particular purpose, nor does SCILLC assume any liability arising out of the application or use of any product or circuit, and specifically disclaims any and all liability, including without limitation special, consequential or incidental damages. "Typical" parameters which may be provided in SCILLC data sheets and/or specifications can and do vary in different applications and actual performance may vary over time. All operating parameters, including "Typicals" must be validated for each customer application by customer's technical experts. SCILLC does not convey any license under its patent rights nor the rights of others. SCILLC products are not designed, intended, or authorized for use as components in systems intended for surgical implant into the body, or other applications intended to support or sustain life, or for any other application in which the failure of the SCILLC product could create a situation where personal injury or death may occur. Should Buyer purchase or use SCILLC products for any such unintended or unauthorized application, Buyer shall indemnify and hold SCILLC and its officers, employees, subsidiaries, affiliates, and distributors harmless against all claims, costs, damages, and expenses, and reasonable attorney fees arising out of, directly or indirectly, any claim of personal injury or death associated with such unintended or unauthorized use, even if such claim alleges that SCILLC was negligent regarding the design or manufacture of the part. SCILLC is an Equal Opportunity/Affirmative Action Employer. This literature is subject to all applicable copyright laws and is not for resale in any manner.

### PUBLICATION ORDERING INFORMATION

**LITERATURE FULFILLMENT:**  
Literature Distribution Center for ON Semiconductor  
P.O. Box 61312, Phoenix, Arizona 85082-1312 USA  
**Phone:** 480-829-7710 or 800-344-3860 Toll Free USA/Canada  
**Fax:** 480-829-7709 or 800-344-3867 Toll Free USA/Canada  
**Email:** orderlit@onsemi.com

**N. American Technical Support:** 800-282-9855 Toll Free  
USA/Canada

**Japan:** ON Semiconductor, Japan Customer Focus Center  
2-9-1 Kamimeguro, Meguro-ku, Tokyo, Japan 153-0051  
**Phone:** 81-3-5773-3850

**ON Semiconductor Website:** <http://onsemi.com>

**Order Literature:** <http://www.onsemi.com/litorder>

For additional information, please contact your local Sales Representative.

**NTD20P06L/D**